

QuickScan™ 2500 Family

PRODUCT REFERENCE GUIDE



General Purpose
Handheld Area Imager Bar Code Reader

 **DATALOGIC**

Datalogic S.r.l.

Via S. Vitalino, 13
40012 Calderara di Reno (BO)
Italy
Tel. +39 051 3147011
Fax +39 051 3147205

© 2022-2023 Datalogic S.p.A. and /or its affiliates

All rights reserved. Without limiting the rights under copyright, no part of this documentation may be reproduced, stored in or introduced into a retrieval system, or transmitted in any form or by any means, or for any purpose, without the express written permission of Datalogic S.p.A. and/or its affiliates.

Owners of Datalogic products are hereby granted a non-exclusive, revocable license to reproduce and transmit this documentation for the purchaser's own internal business purposes. Purchaser shall not remove or alter any proprietary notices, including copyright notices, contained in this documentation and shall ensure that all notices appear on any reproductions of the documentation.

Electronic versions of this document may be downloaded from the Datalogic website (www.datalogic.com). If you visit our website and would like to make comments or suggestions about this or other Datalogic publications, please let us know via the "Contact" page.

Disclaimer

Datalogic has taken reasonable measures to provide information in this manual that is complete and accurate, however, Datalogic shall not be liable for technical or editorial errors or omissions contained herein, nor for incidental or consequential damages resulting from the use of this material. Datalogic reserves the right to change any specification at any time without prior notice.

Trademarks

Datalogic and the Datalogic logo are registered trademarks of Datalogic S.p.A. in many countries, including the U.S.A. and the E.U.

QuickScan is a trademark of Datalogic S.p.A. and/or its affiliates, registered in the U.S. The Bluetooth word mark and logos are owned by Bluetooth SIG, Inc. and any use of such marks by Datalogic S.p.A. and/or its affiliates is under license. All other trademarks and brands are property of their respective owners.

Patents

See www.patents.datalogic.com for patent list.

TABLE OF CONTENTS

PREFACE	XIII
About this Manual	xiii
Overview	xiii
Manual Conventions	xiv
Technical Support	xiv
Support Through the Website	xiv
Reseller Technical Support	xiv
.....	xiv
CHAPTER 1. INTRODUCTION	1
About the Reader	1
Using the QuickScan™ 2500 Reader	2
QuickScan™ 2500 Aiming System	3
QuickScan™ QD/QBT/QM2500	3
QuickScan™ QW2500	4
Battery Safety	6
Programming the Reader	8
Configuration Methods	8
Programming Bar Codes	8
Datalogic Aladdin™	8
CHAPTER 2. SETUP	9
Unpacking	9
Setting Up the QuickScan™ QD/QW2500 Reader	9
Reader and LED Description	9
Connecting the Host Interface	10
RS-232 Serial Connection (QuickScan™ QD2590 only)	10
Keyboard Wedge Connection (QuickScan™ QD2590 only)	11
USB Connection	11
Stand Installation	12
Hands-Free Stand	12
End-Cap Cover	13
End-cap cover disassembly procedure	13
Setting up the QuickScan™ QBT/QM2500 Reader	14
Charging the Batteries	14
Replacing The Battery Pack	15
Base Station Installation	16
Scanner and Radio Base LEDs	17
Connecting the Base Station	19
Base Station Connection and Routing	19
Securing the DC Power Cord (Optional)	19
Host Connection	19
Power Connection	20
Disconnecting the Cable	20
System and Network Layouts	21
Stand Alone Layouts	21
Interface Selection	22
Configuring the Interface	22

Customizing Configuration Settings	24
Using the Programming Bar Codes	24
Datalogic Aladdin™ Utility	25
Interface Settings	25
Configuring Other Features	25
Software Version Transmission	26
Resetting the Product Configuration to Defaults	26
Restore Custom Default Configuration	26
Restore Factory Configuration	26
CHAPTER 3. CONFIGURATION WITH BAR CODES.....	27
Configuration Parameters	27
Interface Configuration:	27
Parameters common to all interface applications:	27
Symbology-specific parameters:	28
GLOBAL INTERFACE FEATURES	29
Host Commands — Obey/Ignore	29
USB Suspend Mode	29
RS-232 INTERFACE.....	30
RS-232 STANDARD SETTINGS	31
Baud Rate	31
Data Bits	32
Stop Bits	32
Parity	33
Handshaking Control	34
RS-232/USB-COM INTERFACES	35
RS-232/USB-COM SETTINGS	36
Intercharacter Delay	36
Beep On ASCII BEL	37
Beep On Not on File	37
ACK NAK Options	38
ACK Character	39
NAK Character	39
ACK NAK Timeout Value	40
ACK NAK Retry Count	40
ACK NAK Error Handling	41
Indicate Transmission Failure	41
Disable Character	42
Enable Character	42
KEYBOARD INTERFACE	43
COUNTRY MODE	44
Setup on PC to use ALT Universal	44
Setting Country Mode	45
OTHER KEYBOARD PARAMETERS	59
Encoding Type	59
ALT Output Type	66
Caps Lock State	67
Numlock	67
Keyboard Numeric Keypad	68
Keyboard Send Control Characters	68
Wedge Quiet Interval	69
Intercharacter Delay	69
Intercode Delay	70
USB Keyboard Speed	71
USB-OEM INTERFACE	72
USB-OEM Device Usage	73
IBM 46XX INTERFACE	74
IBM 46xx Interface Options	75
DATA FORMAT	76
GLOBAL SETTINGS	77
Global Prefix/Suffix	77

Case Conversion	78
Character Conversion	78
Global AIM ID	79
GS1-128 AIM ID	79
LABEL ID	80
Label ID: Pre-loaded Sets	80
Label ID: Set Individually Per Symbology	81
Label ID Control	81
Label ID Symbology Selection	82
READING PARAMETERS	87
SCANNING FEATURES	88
Scan Mode	88
Scanning Active Time	89
Flash On Time	89
Flash Off Time	90
Double Read Timeout	90
Stand /Base Detection Behavior (QuickScan™ QD2500 only)	92
Stand Mode/Object Detection Indication (Stand Mode Flash)	93
Stand Mode/Object Detection Sensitivity	93
Stand Mode/Object Detection Illumination Off Time	94
Corded Stand Mode	94
Dock Detection Beep	95
LED AND BEEPER INDICATORS	96
Power On Alert	96
Good Read Beep Type	96
Good Read Beep Frequency	97
Good Read Beep Length	98
Good Read Beeper Volume	99
Silent Mode (not available for QW2500)	100
Good Read LED Duration	101
Good Read: When to Indicate	102
Green Spot Duration	103
Illuminator Intensity	104
CAMERA CONTROL	105
Aiming Pointer	105
Aiming Duration Timer	105
Pick Mode	106
Mobile Phone Mode	106
Mobile Phone Saturation Rate	107
Decode Negative Image	108
Image Capture	108
MULTIPLE LABEL READING	109
Multiple Labels per Frame	109
Multiple Labels Ordering by Code Symbology	109
Multiple Labels Ordering by Code Length	110
1D SYMBOLOGIES	111
DISABLE ALL SYMBOLOGIES	112
COUPON CONTROL	112
Coupon Control	112
UPC-A	113
UPC-A Enable/Disable	113
UPC-A Check Character Transmission	113
Expand UPC-A to EAN-13	114
UPC-A Number System Character Transmission	114
UPC-E	115
UPC-E Enable/Disable	115
UPC-E Check Character Transmission	115
Expand UPC-E to EAN-13	116
Expand UPC-E to UPC-A	116
UPC-E Number System Character Transmission	116
GTIN Formatting	117

EAN-13	118
EAN-13 Enable/Disable	118
EAN-13 Check Character Transmission	118
EAN-13 Flag 1 Character	119
EAN-13 to ISBN Conversion	119
EAN-13 to ISSN Conversion	120
EAN-8	121
EAN-8 Enable/Disable	121
EAN-8 Check Character Transmission	121
Expand EAN-8 to EAN-13	122
UPC/EAN GLOBAL SETTINGS	123
UPC/EAN Price Weight Check	123
UPC/EAN Quiet Zones	124
Add-Ons	125
Optional Add-ons	125
Optional Add-On Timer	126
GS1 DATABAR™ OMNIDIRECTIONAL	127
GS1 DataBar Omnidirectional Enable/Disable	127
GS1 DataBar Omnidirectional to GS1-128 Emulation	127
GS1 DATABAR™ EXPANDED	128
GS1 DataBar Expanded Enable/Disable	128
GS1 DataBar Expanded to GS1-128 Emulation	128
GS1 DataBar Expanded Length Control	129
GS1 DataBar Expanded Set Length 1	129
GS1 DataBar Expanded Set Length 2	130
GS1 DATABAR™ LIMITED	131
GS1 DataBar Limited Enable/Disable	131
GS1 DataBar Limited to GS1-128 Emulation	131
CODE 39	132
Code 39 Enable/Disable	132
Code 39 Check Character Calculation	132
Code 39 Check Character Transmission	133
Code 39 Start/Stop Character Transmission	133
Code 39 Full ASCII	134
Code 39 Quiet Zones	134
Code 39 Length Control	135
Code 39 Set Length 1	135
Code 39 Set Length 2	136
TRIOPTIC CODE	137
Trioptic Code Enable/Disable	137
CODE 39 DANISH PPT	137
Code 39 Danish PPT Enable/Disable	137
CODE 39 PZN	138
Code 39 PZN Enable/Disable	138
CODE 39 LA POSTE	138
Code 39 La Poste Enable/Disable	138
CODE 32 (ITALIAN PHARMACEUTICAL)	139
Code 32 Enable/Disable	139
Code 32 Feature Setting Exceptions	139
Code 32 Check Character Transmission	139
Code 32 Start/Stop Character Transmission	140
CODE 39 CIP HR (FRENCH PHARMACEUTICAL)	140
Code 39 CIP HR Enable/Disable	140
CODE 128	141
Code 128 Enable/Disable	141
Expand Code 128 to Code 39	141
Code 128 Check Character Transmission	142
Code 128 Function Character Transmission	142
Code 128 Quiet Zones	143
Code 128 Length Control	143
Code 128 Set Length 1	144

Code 128 Set Length 2	144
GS1-128	145
GS1-128 Enable	145
INTERLEAVED 2 OF 5 (I 2 OF 5)	146
I 2 of 5 Enable/Disable	146
I 2 of 5 Check Character Calculation	147
I 2 of 5 Check Character Transmission	148
I 2 of 5 Length Control	149
I 2 of 5 Set Length 1	149
I 2 of 5 Set Length 2	150
INTERLEAVED 2 OF 5, FEBRABAN (DESK MODELS ONLY)	151
Interleaved 2 of 5, Febraban format Enable / Disable	151
INTERLEAVED 2 OF 5 CIP HR	151
Interleaved 2 of 5 CIP HR Enable/Disable	151
MATRIX 2 OF 5	152
Matrix 2 of 5 Enable/Disable	152
Matrix 2 of 5 Check Character Calculation	152
Matrix 2 of 5 Check Character Transmission	153
Matrix 2 of 5 Length Control	153
Matrix 2 of 5 Set Length 1	154
Matrix 2 of 5 Set Length 2	154
STANDARD 2 OF 5	155
Standard 2 of 5 Enable/Disable	155
Standard 2 of 5 Check Character Calculation	155
Standard 2 of 5 Check Character Transmission	156
Standard 2 of 5 Length Control	156
Standard 2 of 5 Set Length 1	157
Standard 2 of 5 Set Length 2	157
COMPRESSED 2 OF 5	158
Compressed 2 of 5 Enable/Disable	158
Compressed 2 of 5 Check Character Calculation	158
Compressed 2 of 5 Check Character Transmission	159
Compressed 2 of 5 Length Control	159
Compressed 2 of 5 Set Length 1	160
Compressed 2 of 5 Set Length 2	160
DATALOGIC 2 OF 5	161
Datalogic 2 of 5 Enable/Disable	161
Datalogic 2 of 5 Check Character Calculation	161
Datalogic 2 of 5 Check Character Transmission	162
Datalogic 2 of 5 Length Control	162
Datalogic 2 of 5 Set Length 1	163
Datalogic 2 of 5 Set Length 2	163
INDUSTRIAL 2 OF 5	164
Industrial 2 of 5 Enable/Disable	164
Industrial 2 of 5 Check Character Calculation	164
Industrial 2 of 5 Check Character Transmission	165
Industrial 2 of 5 Length Control	165
Industrial 2 of 5 Set Length 1	166
Industrial 2 of 5 Set Length 2	166
IATA	167
IATA Enable/Disable	167
IATA Check Character Transmission	167
FOLLETT 2 OF 5	168
Follett 2 of 5 Enable/Disable	168
CODABAR	169
Codabar Enable/Disable	169
Codabar Check Character Calculation	169
Codabar Check Character Transmission	170
Codabar Start/Stop Character Transmission	170
Codabar Start/Stop Character Set	171

Codabar Start/Stop Character Match	171
Codabar Quiet Zones	172
Codabar Length Control	173
Codabar Set Length 1	173
Codabar Set Length 2	174
ABC CODABAR	175
ABC Codabar Enable/Disable	175
ABC Codabar Concatenation Mode	175
ABC Codabar Dynamic Concatenation Timeout	176
ABC Codabar Force Concatenation	176
ISBT 128	177
ISBT 128 Concatenation	177
ISBT 128 Concatenation Mode	177
ISBT 128 Dynamic Concatenation Timeout	178
ISBT 128 Force Concatenation	179
ISBT 128 Advanced Concatenation Options	179
CODE 11	180
Code 11 Enable/Disable	180
Code 11 Check Character Calculation	180
Code 11 Check Character Transmission	181
Code 11 Length Control	181
Code 11 Set Length 1	182
Code 11 Set Length 2	182
CODE 93	183
Code 93 Enable/Disable	183
Code 93 Check Character Calculation	183
Code 93 Check Character Transmission	184
Code 93 Length Control	184
Code 93 Set Length 1	185
Code 93 Set Length 2	185
Code 93 Quiet Zones	186
MSI	187
MSI Enable/Disable	187
MSI Check Character Calculation	187
MSI Check Character Transmission	188
MSI Length Control	188
MSI Set Length 1	189
MSI Set Length 2	189
PLESSEY	190
Plessey Enable/Disable	190
Plessey Check Character Calculation	190
Plessey Check Character Transmission	191
Plessey Length Control	191
Plessey Set Length 1	192
Plessey Set Length 2	192
BC412	193
BC412 Enable/Disable	193
BC412 Check Character Calculation	193
BC412 Length Control	194
BC412 Set Length 1	195
BC412 Set Length 2	195
2D SYMBOLOGIES	196
2D GLOBAL FEATURES	197
2D Maximum Decoding Time	198
2D Structured Append	199
2D Normal/Inverse Symbol Control	199
AZTEC CODE	200
Aztec Code Enable / Disable	200
Aztec Code Length Control	200
Aztec Code Set Length 1	201
Aztec Code Set Length 2	201

CHINA SENSIBLE CODE	202
China Sensible Code Enable / Disable	202
China Sensible Code Length Control	202
China Sensible Code Set Length 1	203
China Sensible Code Set Length 2	203
DATA MATRIX	204
Data Matrix Enable / Disable	204
Data Matrix Square/Rectangular Style	204
Data Matrix Length Control	205
Data Matrix Set Length 1	205
Data Matrix Set Length 2	206
GS1 DOTCODE	207
DotCode Enable	207
DotCode High Resolution Enable	207
DotCode Position-based Decoding	208
Additional Options	208
MAXICODE	209
Maxicode Enable / Disable	209
Maxicode Primary Message Transmission	209
Maxicode Length Control	210
Maxicode Set Length 1	210
Maxicode Set Length 2	211
PDF417	212
PDF417 Enable / Disable	212
PDF417 Length Control	212
PDF417 Set Length 1	213
PDF417 Set Length 2	213
MICRO PDF417	214
Micro PDF417 Enable / Disable	214
Micro PDF417 Code 128 GS1-128 Emulation	214
Micro PDF417 Length Control	215
Micro PDF417 Set Length 1	215
Micro PDF417 Set Length 2	216
QR CODE	217
QR Code Enable / Disable	217
QR Code Length Control	217
QR Code Set Length 1	218
QR Code Set Length 2	218
MICRO QR CODE	219
Micro QR Code Enable / Disable	219
Micro QR Code Length Control	219
Micro QR Code Set Length 1	220
Micro QR Code Set Length 2	220
UCC COMPOSITE	221
UCC Optional Composite Timer	221
Postal Code Selection	222
Postnet BB Control	223
OCR DECODING	224
OCR Decoding Predefined Templates	225
MOTION FEATURES	226
Motionless Timeout	227
Motion Sensitivity	227
High Motion Immunity	228
Motion Aiming Control	228
DOF Enhancement (Not available for QW2500)	229
POWER MANAGEMENT	230
POWER SAVE	231
Powerdown Timeout	231
BATTERY PROFILES	232
Battery Profiles	232
Battery Information	233

WIRELESS FEATURES	234
WIRELESS BEEPER FEATURES	235
Good Transmission Beep	235
Beeper Frequency	235
Beep Duration	236
Beep Volume	237
Disconnect Beep	237
Docking (Connecting) Beep	238
Leash Alarm	238
CONFIGURATION UPDATES	240
Automatic Configuration Update	240
Copy Configuration to Reader	240
Copy Configuration to Base Station	240
BATCH FEATURES	241
Batch Mode	241
Send Batch	241
Erase Batch Memory	242
RF Batch Mode Transmit Delay	242
DIRECT RADIO AUTOLINK	243
Direct Radio Autolink	243
RF ADDRESS STAMPING	244
Source Radio Address Transmission	244
Source Radio Address Delimiter Character	244
BLUETOOTH-ONLY FEATURES	245
Bluetooth Security Level	245
Wi-Fi Channels Exclusion	247
Bluetooth Discoverable Mode Timeout	252
Bluetooth Friendly Name	253
BLUETOOTH HID FEATURES	254
Bluetooth HID Alt Mode	254
FEATURES FOR STAR MODELS ONLY	255
STAR Radio Protocol Timeout	255
STAR Radio Transmit Mode	256
STAR System Speed	257
STAR Frequency Agility	258
CHAPTER 4. REFERENCES	260
RS-232 Parameters	261
RS-232 Only	261
Baud Rate	261
Data Bits	261
Stop Bits	261
Parity	261
Handshaking Control	261
RS-232/USB COM Parameters	262
Intercharacter Delay	262
ACK NAK Options	263
ACK Character	263
NAK Character	264
ACK NAK Timeout Value	265
ACK NAK Retry Count	266
Disable Character	267
Enable Character	268
Keyboard Interface (Not available for QW2500/QD2520)	269
Wedge Quiet Interval	269
Intercharacter Delay	270
Intercode Delay	271
Data Format	272
Data Editing	272
Please Keep In Mind...	272
Global Prefix/Suffix	273

Example: Setting a Prefix	273
Global AIM ID	274
Label ID	275
Label ID: Pre-loaded Sets	275
Label ID: Set Individually Per Symbology	277
Character Conversion	279
Scanning Features	280
Scan Mode	280
Scanning Active Time	280
Aiming Duration Time	282
Flash On Time	283
Flash Off Time	284
LED and Beeper Indicators	285
Good Read LED Duration	285
RF Features	286
Automatic Configuration Update	286
RF Address Stamping	286
Source Radio Address Delimiter Character	286
STAR Radio Protocol Timeout	287
Symbologies	288
Set Length	288
Set Length 1	288
Set Length 2	289
CHAPTER 5. MESSAGE FORMATTING	290
Message Formatting	290
LED and Beeper Control	291
APPENDIX A. TECHNICAL SPECIFICATIONS	292
QuickScan™ 2500 Technical Specifications	292
Common Reading Characteristics	296
Decoding Capabilities	297
LED and Beeper Indications	298
User Indications for QD/QW2500	298
User Indications for QBT/QM2500 (Gun Only)	299
User Indications for BC2090 Base Stations	301
Programming Mode	302
Troubleshooting	302
Cleaning Procedure	304
Common Cleaning Solutions	304
Cleaning enclosure and window surfaces	305
Cleaning electrical contact surfaces	305
Scanner Contacts	305
Scanner and cradle deep cleaning	306
APPENDIX B. STANDARD DEFAULTS.....	307
Default exceptions	320
APPENDIX C. SAMPLE BARCODES.....	322
Sample Barcodes	322
1D Barcodes	322
GS1 Databar™ (RSS)	324
GS1 Databar™ (-14)	324
2D Barcodes	325
APPENDIX D. KEYPAD.....	327
APPENDIX E. SCANCODE TABLES	329
Control Character Emulation	329
Single Press and Release Keys	329

Interface Type PC AT PS/2, USB-Keyboard or USB-Keyboard for APPLE	330
Interface Type PC AT PS/2, USB-Keyboard or USB-Keyboard for APPLE (continued)	331
Interface Type PC AT PS/2 Alt Mode or USB-Keyboard Alt Mode	332
Interface Type PC AT PS/2 Alt Mode or USB-Keyboard Alt Mode (continued)	333
Digital Interface	334
IBM31xx 102-key	335
IBM XT	337
Microsoft Windows Codepage 1252	339
APPENDIX F. ASCII CHART.....	340

PREFACE

ABOUT THIS MANUAL

This Product Reference Guide (PRG) is provided for users seeking advanced technical information, including connection, programming, maintenance and specifications. The Quick Reference Guide (QRG) and other publications associated with this product are downloadable free of charge from the website listed on the back cover of this manual.

Typically, units are factory-programmed for the most common terminal and communications settings. If you need to modify any programmable settings, custom configuration can be accomplished by scanning the programming bar codes within this guide.

Programming can alternatively be performed using the Datalogic Aladdin™ Configuration application, which is available from the Datalogic website listed on the back cover of this manual. This multi-platform utility program allows device configuration using a PC. It communicates to the device using a serial or USB cable and can also create configuration bar codes to print.

OVERVIEW

Chapter 1, Introduction provides a product overview, battery safety information, and general information about programming the reader.

Chapter 2, Setup presents information about unpacking and setting up the reader, and interface configuration bar codes and details.

Chapter 3, Configuration Using Bar Codes provides instructions and bar code labels for customizing your reader. There are different sections for interface types, general features, data formatting, and symbology-specific features.

Chapter 4, References provides details concerning programmable features.

Appendix A, Technical Specifications lists physical and performance characteristics, as well as environmental specifications. It also provides standard cable pin-outs and descriptions of the functions and behaviors of the reader's LED and Beeper indicators.

Appendix B, references common factory default settings for reader features and options.

Appendix C, Sample Bar Codes offers sample bar codes of several common symbologies.

Appendix D, Keypad includes numeric bar codes to be scanned for certain parameter settings.

Appendix E, Scancode Tables lists control character emulation information for USB Keyboard interface.

Appendix F, ASCII Chart lists hexadecimal reference values for ASCII characters.

Manual Conventions

The following conventions are used in this document:

The symbols listed below are used in this manual to notify the reader of key issues or procedures that must be observed when using the reader:



NOTE: This symbol draws attention to details or procedures that may be useful in improving, maintaining, or enhancing the performance of the hardware or software being discussed.



CAUTION: This symbol advises you of actions that could damage equipment or property.



WARNING: This symbol advises you of actions that could result in harm or injury to the person performing the task.



HIGH VOLTAGE: This symbol alerts the user they are about to perform an action involving, either a dangerous level of voltage, or to warn against an action that could result in damage to devices or electrical shock.



LASER: This symbol alerts the user they are about to perform an action involving possible exposure to laser light radiation.



GROUNDING: This symbol advises you to pay particular attention to the grounding instructions for correct device functioning.



ESD: This symbol identifies a procedure that requires you take measures to prevent Electrostatic Discharge (ESD) e.g., use an ESD wrist strap. Circuit boards are most at risk. Please follow ESD procedures.

TECHNICAL SUPPORT

Support Through the Website

Datalogic provides several services as well as technical support through its website. Log on to (www.datalogic.com).

For quick access, from the home page click on the search icon , and type in the name of the product you're looking for. This allows you access to download Data Sheets, Manuals, Software & Utilities, and Drawings.

Hover over the Support & Service menu for access to Services and Technical Support.

Reseller Technical Support

An excellent source for technical assistance and information is an authorized Datalogic reseller. A reseller is acquainted with specific types of businesses, application software, and computer systems and can provide individualized assistance.

CHAPTER 1

INTRODUCTION

ABOUT THE READER

The QuickScan 2500™ product series represents the hand-held entry level corded or cordless scanner by Datalogic. It has been specifically created for small to medium size Retailers, such as groceries and convenience stores, operating in both food and non-food sectors.

Providing the quickest response to the operator for its class of products, the 2500 scanner is able to capture whatever barcode, hard-to-read, poor or damaged. It easily scans from mobile devices and through plexiglass barriers.

Lightweight and easy to handle also for female users, it is a reliable and seamless companion throughout the whole shift.

The 2500 scanner features a precise aiming system developed with the unique intent to reduce visual stress of the operator during the daily scanning activities. While the QW2500 model features a very intuitive blue dot aimer, the more sophisticated, extreme precision aimer of the QD/QBT/QM2500 models, consists of two blue LED triangles pointing at the targeted bar code. The Green Spot confirms the good read, being perfectly centered on the barcode and between the two triangles.

Very responsive at the pull of the trigger, the QuickScan 2500 provides a superior robustness for its class of products, thanks to an accurate design and quality of parts, right there where the product is mostly stressed.

Perfect for manual reading, the QuickScan 2500 uses Datalogic's Motionix™ motion detection technology that detects the operator's natural actions to automatically switch the scanner into “ready to read” scan mode.

The product range is wide, with two colors – black and white – and a variety of different stands, holders and accessories to provide the best fit for each working environment.

USING THE QUICKSCAN™ 2500 READER

To read a symbol or capture an image, simply aim the reader and pull the trigger. The QuickScan™ 2500 is a powerful omni-directional reader, so the orientation of the symbol is not important. Datalogic's unique 'Green Spot' for good-read feedback helps to improve productivity in noisy environments or in situations where silence is required. When positioning the QuickScan™ QD2500 into the stand, the magnetic coupling will make the reader automatically detect a bar code inside the field of view, and switch the reading system from trigger mode to autosense mode. The same scan mode can be activated on QuickScan™ QW2500 by reading a specific bar code.

The QuickScan™ 2500 readers reliably decode all standard 1D (linear) and 2D bar codes, including GS1 DataBar™ linear codes, Postal Codes (China Post), Stacked Codes (such as GS1 DataBar Expanded Stacked, GS1 DataBar Stacked, GS1 DataBar, Stacked Omnidirectional). The data stream - acquired from decoding a symbol - is rapidly sent to the host. The reader is immediately available to read another symbol.

Figure 1 - Correct positioning of the reader

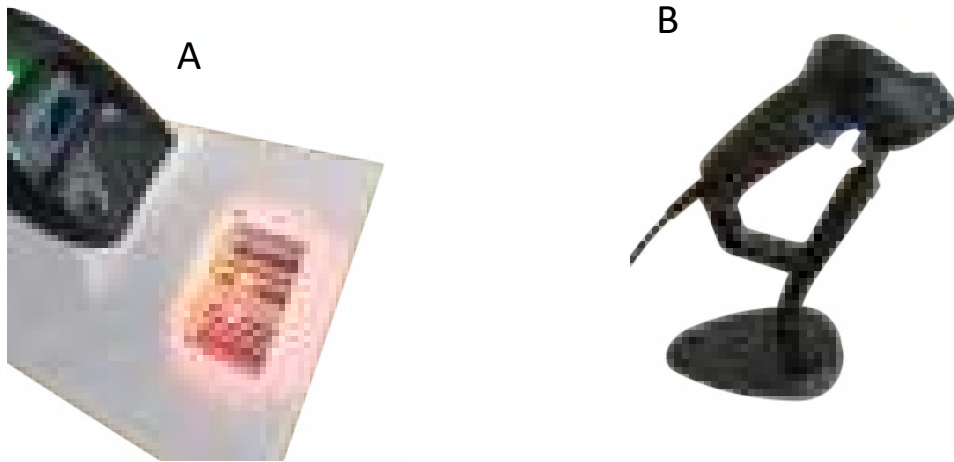

QUICKSCAN™ 2500 AIMING SYSTEM

The QuickScan™ QD2500, QW2500, QBT2500 and QM2500 normally function by capturing and decoding codes. The reader is equipped with an internal Motionix™ motion-sensing function which activates the aiming system on device motion. The intelligent aiming system indicates the field of view which should be positioned over the bar code:

QuickScan™ QD/QBT/QM2500

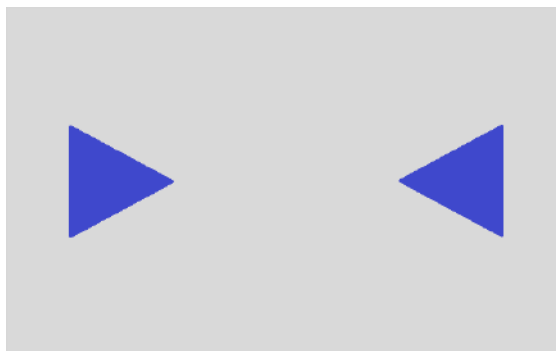

QuickScan™ QD/QBT/QM2500's Aiming System

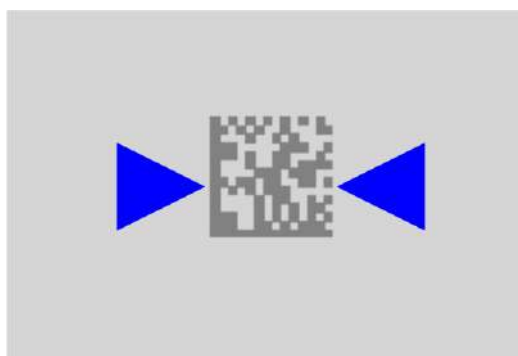

Relative Size and Location of QuickScan™ QD/QBT/QM2500's Aiming System Pattern on 2D Matrix Symbol

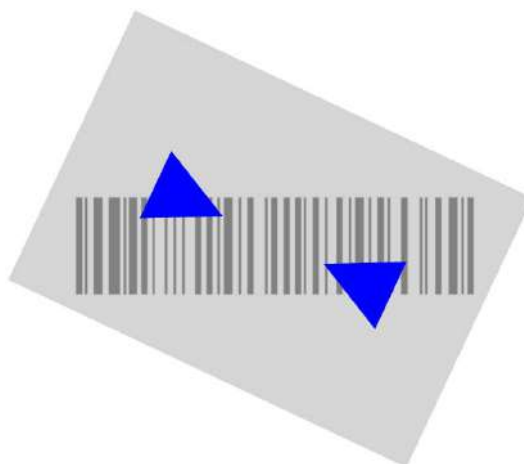

Relative Size and Location of QuickScan™ QD/QBT2500's Aiming System Pattern on Linear bar code

QuickScan™ QW2500

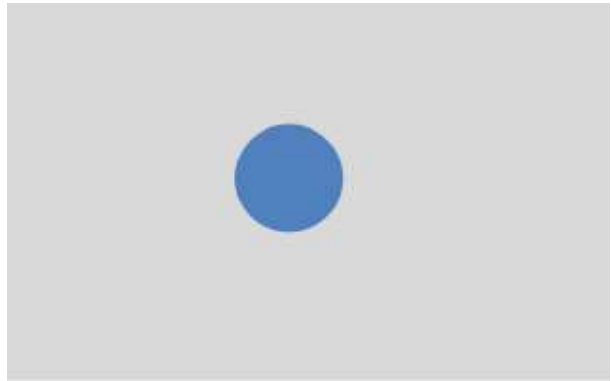

QuickScan™ QW2500's Aiming System

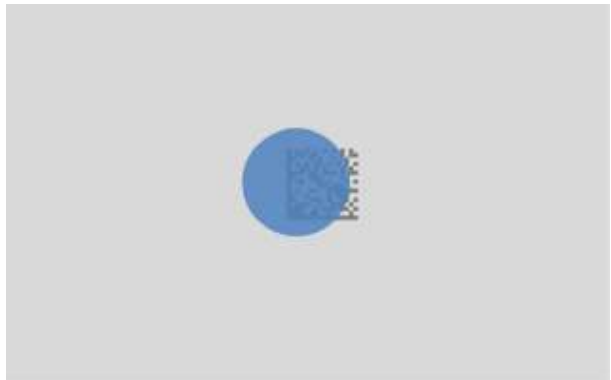

Relative Size and Location of QuickScan™ QW2500's Aiming System Pattern on 2D Matrix Symbol

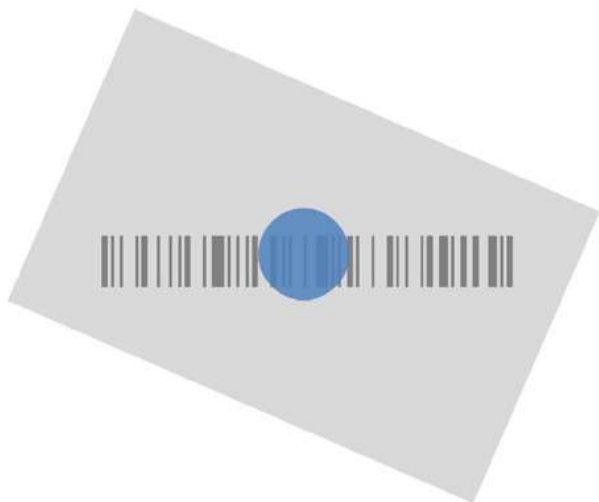

Relative Size and Location of QuickScan™ QW2500's Aiming System Pattern on Linear bar code

A beam illuminates the label. The projected pattern of the aiming system will be smaller when the reader is closer to the bar code and larger when it is farther from the code. Symbologies with smaller bars or elements (mil size) should be read closer to the unit. Symbologies with larger bars or elements (mil size) should be read farther from the unit. If the aiming system is centered you will get a good read. Successful reading is signaled by an audible tone plus a good-read green spot LED indicator.

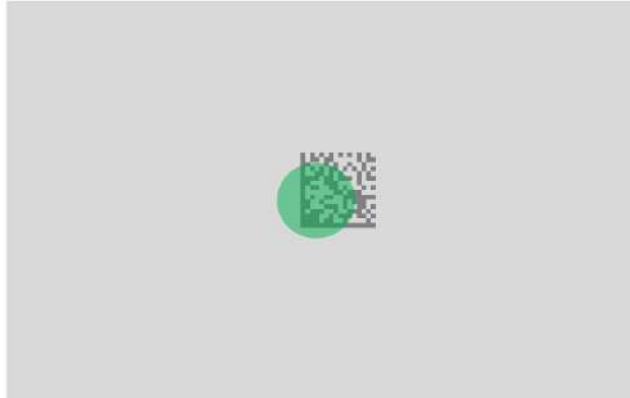

Relative Size and Location of Green Spot

BATTERY SAFETY

To reinstall, charge and/or perform any other action on the battery, follow the instructions in this manual.



NOTE: Before installing the Battery, read “Battery Safety” on this and the following pages. Datalogic recommends annual replacement of rechargeable battery packs to ensure maximum performance.



WARNING: Do not discharge the battery using any device except for the reader. When the battery is used in devices other than the designated product, it may damage the battery or reduce its life expectancy. If the device causes an abnormal current to flow, it may cause the battery to become hot, explode or ignite and cause serious injury.

Lithium-ion battery packs may get hot, explode or ignite and cause serious injury if exposed to abusive conditions. Be sure to follow the safety warnings listed below:

- Do not place the battery pack in fire or heat.
- Do not connect the positive terminal and negative terminal of the battery pack to each other with any metal object (such as wire).
- Do not carry or store the battery pack together with metal objects.
- Do not pierce the battery pack with nails, strike it with a hammer, step on it or otherwise subject it to strong impacts or shocks.
- Do not solder directly onto the battery pack.
- Do not expose the battery pack to liquids, or allow the battery to get wet.
- Do not apply voltages to the battery pack contacts.

In the event the battery pack leaks and the fluid gets into your eye, do not rub the eye. Rinse well with water and immediately seek medical care. If left untreated, the battery fluid could cause damage to the eye.



CAUTION: Always charge the battery at 32° – 104°F (0° - 40°C) temperature range.

Use only the authorized power supplies, battery pack, chargers, and docks supplied by your Datalogic reseller. The use of any other power supplies can damage the device and void your warranty.

Do not disassemble or modify the battery. The battery contains safety and protection devices, which, if damaged, may cause the battery to generate heat, explode or ignite.

Do not place the battery in or near fire, on stoves or other high temperature locations.

Do not place the battery in direct sunlight, or use or store the battery inside cars in hot weather. Doing so may cause the battery to generate heat, explode or ignite. Using the battery in this manner may also result in a loss of performance and a shortened life expectancy.

Do not place the battery in microwave ovens, high-pressure containers or on induction cookware.

Immediately discontinue use of the battery if, while using, charging or storing the battery, the battery emits an unusual smell, feels hot, changes color or shape, or appears abnormal in any other way.

Do not replace the battery pack when the device is turned on.

Do not remove or damage the battery pack’s label.

Do not use the battery pack if it is damaged in any part.

Battery pack usage by children should be supervised.



CAUTION: Storage of batteries for long time at fully charged status or at fully discharged status should be avoided.



CAUTION: Only in case of long storage, to avoid deep discharge of the battery it is recommended to partially recharge the battery every three months to keep the charge status at a medium level.

As a reference, run a fast recharge for 20 minutes every three months on unused products to avoid any performance deterioration of the cell.

As with other types of batteries, Lithium-Ion (LI) batteries will lose capacity over time. Capacity deterioration is noticeable after one year of service whether the battery is in use or not. It is difficult to precisely predict the finite life of a LI battery, but cell manufacturers rate them at 500 charge cycles. In other words, the batteries should be expected to take 500 full discharge / charge cycles before needing replacement. This number is higher if partial discharging / recharging is adhered to rather than full / deep discharging,

The typical manufacturer advertised useful life of LI batteries is one to three years, depending on usage and number of charges, etc., after which they should be removed from service, especially in mission critical applications. Do not continue to use a battery that is showing excessive loss of capacity, it should be properly recycled / disposed of and replaced. For most applications, batteries should be replaced after one year of service to maintain customer satisfaction and minimize safety concerns. Collect and recycle waste batteries separately from the device in compliance with European Directive 2006/66/EC, 2011/65/EU, 2002/96/EC and 2012/19/EU and subsequent modifications, US and China regulatory and others laws and regulations about the environment.

PROGRAMMING THE READER

**NOTE: For QuickScan™ QW2500**

Read the following label to change Scan Mode to allow the user to operate in hands-free mode.



Scan Mode = Stand Mode/Object Detection

Configuration Methods

Programming Bar Codes

The reader is factory-configured with a standard set of default features. After scanning the interface bar code, you can select other options and customize your reader through use of the instructions and programming bar code labels available in the corresponding features section for your interface. Customizable settings for many features are found in [Configuration Parameters, starting on page 27](#).

Some programming labels, like “Restore Custom Defaults”, require only the scan of the single label to enact the change. Most, however, require the reader to be placed in Programming Mode prior to scanning them. Scan an ENTER/EXIT bar code once to enter Programming Mode. Once the reader is in Programming Mode, scan a number of parameter settings before scanning the ENTER/EXIT bar code a second time, which will then accept your changes, exit Programming Mode and return the reader to normal operation.



NOTE: There are some exceptions to the typical programming sequence described above. Please read the description and setting instructions carefully when configuring each programmable feature.

Datalogic Aladdin™

Datalogic Aladdin™ is a multi-platform utility program providing a quick and user-friendly configuration method via the RS-232/USB-COM interface. Aladdin allows you to program the reader by selecting configuration commands through a user-friendly graphical interface running on a PC. These commands are sent to the reader over the selected communication interface, or they can be printed as bar codes to be scanned. Aladdin also facilitates image capturing.

In addition, Aladdin makes it easy to upgrade the handheld’s firmware, to attain the benefits of new reader features. Reference the Datalogic Aladdin™ Online Help for more details.

Aladdin is available for download free of charge on the Datalogic website

CHAPTER 2

SETUP

UNPACKING

Check carefully to ensure the reader and any cables or accessories ordered are present and undamaged. If any damage occurred during shipment, contact "Technical Support" on page xiv.

SETTING UP THE QUICKSCAN™ QD/QW2500 READER

Follow the steps provided in this section to connect and get your reader up and communicating with its host:

1. Connect the Interface Cable at the reader as shown in [Figure 3](#). To disconnect the cable, insert a paper clip or similar object into the opening.
2. Connect the other end to the Host (see the next section, "[Connecting the Host Interface](#)" on page 10 and [Figure 4](#)).
3. Modify "[Customizing Configuration Settings](#)" on page 24 (only if modifications are needed from factory settings).

READER AND LED DESCRIPTION

The LED on the gun provides information about the data transmission.

Figure 2 - QuickScan™ QD/QW2500 LED

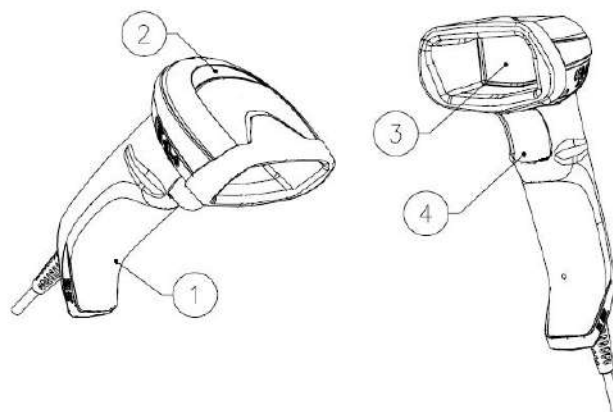

1. Cable Release Hole
2. LED

3. Scan Window
4. Trigger

CONNECTING THE HOST INTERFACE

The reader kit you ordered to match your interface should provide a compatible cable for your installation. If this is not so, contact "Technical Support" on page xiv.

The reader can communicate using the interfaces illustrated on page 22.

For corded versions, connect the reader cable by inserting the cable into the handle as shown in Figure 3.

To remove the interface cable from the reader, first locate the hole on the back of the handle. Next, take a paper clip and modify it as shown in the Figure 3. Insert the end of the paper clip into the hole and press it to push on the clip that holds the connector. As you apply pressure, pull out the cable.

When reinserting the cable, make sure the connector clip is on the same side as the reader release hole. Insert the cable, it should click when it is fully inserted.



NOTE: We recommend the use of a perfectly straight new paper clip to make the operation easier (see the figure below).

Figure 3. Cable Connection/Disconnection at the Reader

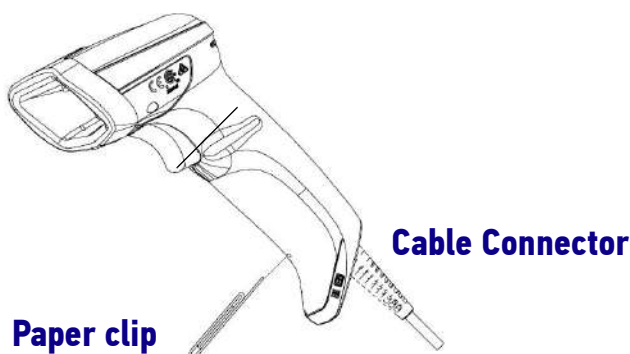

RS-232 Serial Connection (QuickScan™ QD2590 only)

Turn off power to the terminal/PC and connect the reader to the terminal/PC serial port via the RS-232 cable as shown in Figure 4. If the terminal will not support POT (Power Off the Terminal) to supply reader power, use the approved power supply (AC Adapter). Plug the AC Adapter barrel connector into the socket on the RS-232 cable connector and the AC Adapter plug into a standard power outlet.

RS-232: The reader can communicate with a standard or Wincor-Nixdorf (W-N) RS-232 host.

RS-232 OPOS: This interface is used for OPOS/UPOS/JavaPOS systems.



Available only for QuickScan™ QD2590

Keyboard Wedge Connection (QuickScan™ QD2590 only)

The Keyboard Wedge cable has a 'Y' connection from the scanner. Connect the female to the male end from the keyboard and the remaining end at the keyboard port at the terminal/PC.

Keyboard Wedge (KBW) : When connected using this interface, the host interprets scanned data as keystrokes and supports several international keyboards (for the Windows® environment). See "Setting Country Mode" on page 45 for a full listing.

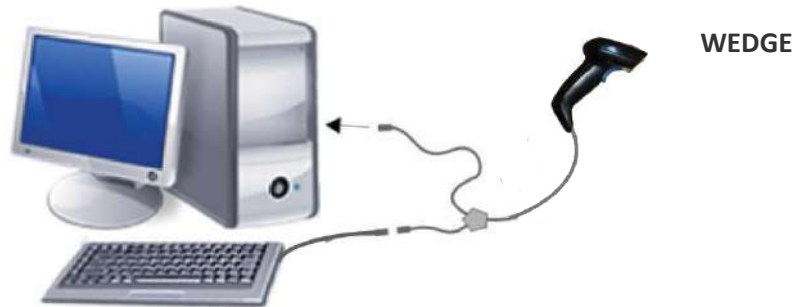

Available only for QuickScan™ QD2590



NOTE: The Wedge interface is supported by products manufactured until June 2023.

USB Connection

Connect the reader to a USB port on the terminal/PC using the correct USB cable for the interface type you ordered.

USB : Select to communicate either by USB OEM, USB COM STD, or USB Keyboard interface types by scanning the appropriate interface type bar codes available in this manual. The default interface is USB-KBD, or RS-232-STD.

Figure 4. Connection to the Host



NOTE: Specific cables are required for connection to different hosts. The connections illustrated in Figure 4 are examples only. Actual connectors may vary from those illustrated, but the steps to connect the reader remain the same.

STAND INSTALLATION

Hands-Free Stand

An accessory is available which holds the QD/QW2500 reader at a convenient angle (except those with integrated stand), allowing hands free scanning of items.

It can also be used as a holder. The holder "cup" can be positioned in any of the angles shown in the [Figure 6 on page 13](#). The QuickScan™ QD2500 models automatically recognize the insertion and changes its Scan Mode to allow the user to operate in hands-free mode.

Figure 5. Hands free holder

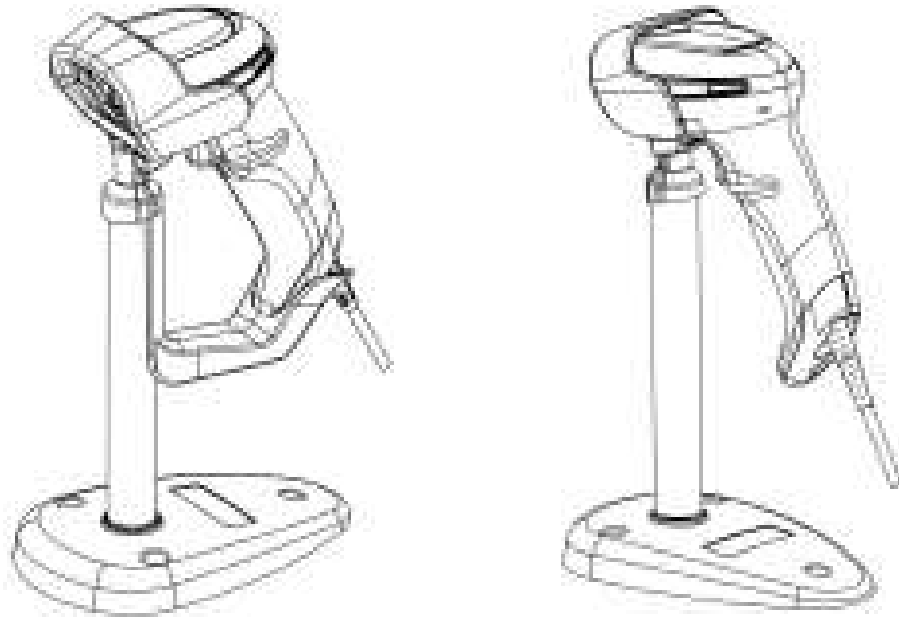

NOTE: For QuickScan™ QD2500, to use the Stand Autosense™ (STD-AUTO-QD25-xx) it is mandatory to remove the End-cap. See "End-Cap Cover" on page 13



NOTE: For QuickScan™ QW2500, read the following label to change Scan Mode to allow the user to operate in hands-free mode.



Scan Mode= Stand Mode/Object Detection

Figure 6. Adjusting the Stand Arm

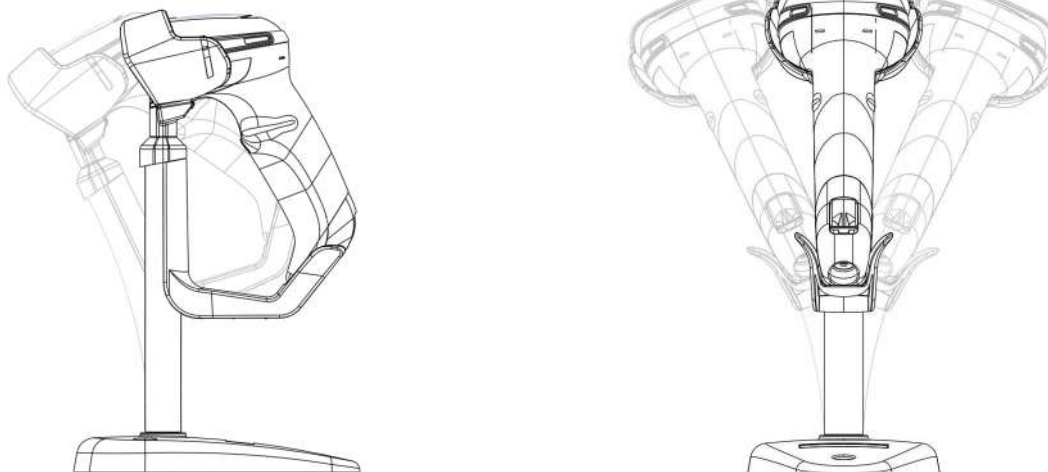

END-CAP COVER



NOTE: For QuickScan™ QD2500, to use the Stand Autosense™ (STD-AUTO-QD25-xx) it is mandatory to remove the End-cap. See the paragraph below.

End-cap cover disassembly procedure

1. Using a small screwdriver or a similar tool pull out the End-Cap from the scanner plastic enclosure.



2. The End-Cap is completely removed from the scanner.



SETTING UP THE QUICKSCAN™ QBT/QM2500 READER

Follow the steps below to connect and get your reader up and communicating with its host.

1. Configure the Base Station starting on [page 19](#).
2. Charge the Batteries.
3. Link to the Base Station (see [page 19](#)).
4. Select the Interface Type (see [page 22](#)).
5. Configure the Reader starting on [page 27](#) (optional, depends on settings needed)

CHARGING THE BATTERIES

The battery can also be charged by connecting the reader directly to a host through the USB Type-C connector available in the bottom of the handle, as shown below.

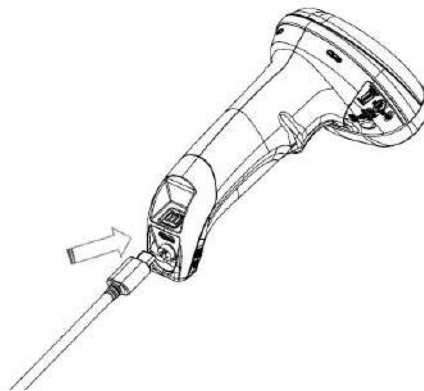

Alternatively, simply insert the QuickScan™ into the base station / charger. When the scanner is fully seated in the base, it will sound a “chirp” to indicate that the base has detected the scanner connection.

The LEDs on the base will indicate the status of the battery. For information about the LEDs see "Technical Specifications" on page 292.



NOTE: Before using the battery, read "Battery Safety" on page 6. Datalogic recommends annual replacement of rechargeable battery packs to ensure maximum performance.

REPLACING THE BATTERY PACK



NOTE: Before using the battery, read "Battery Safety" on page 6. Datalogic recommends annual replacement of rechargeable battery packs to ensure maximum performance.

Use the following procedure to charge the reader's battery:

1. With a screwdriver, unscrew the battery pack screw and extract the battery pack from its slot.

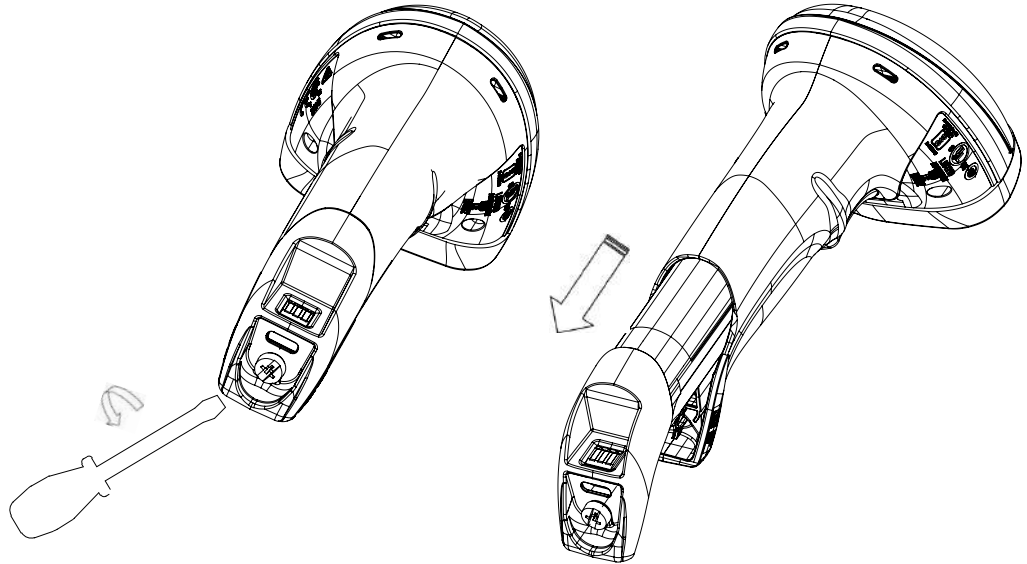

2. Insert the new battery pack in the same position, then insert the screw in the handle and screw it into place.

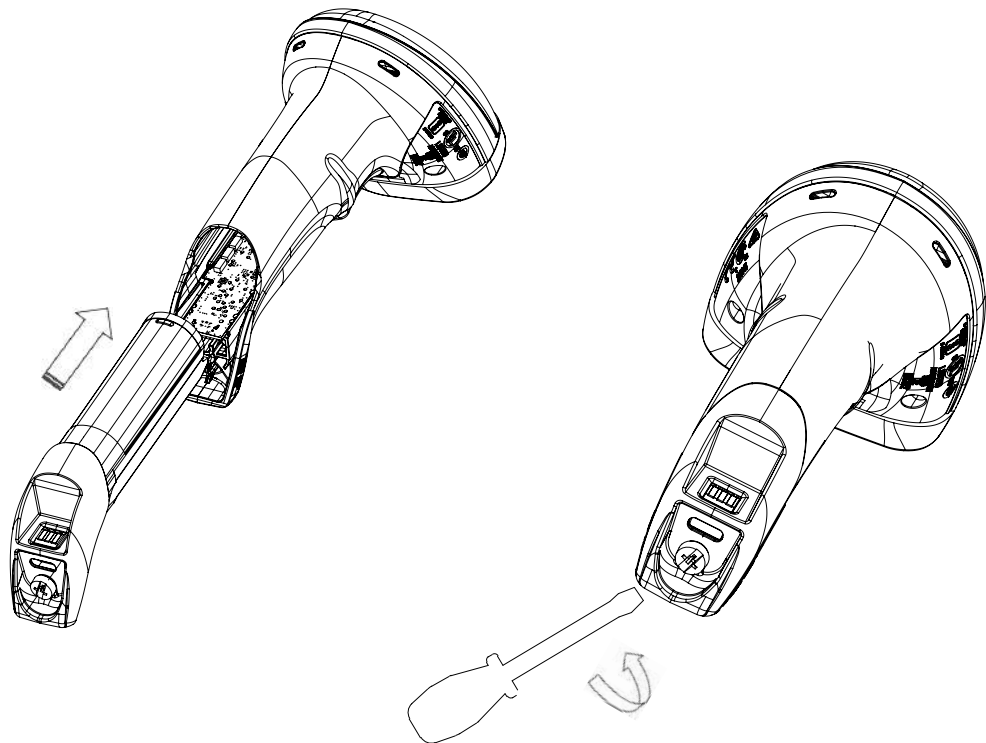

BASE STATION INSTALLATION

The base station/charger may be set up in desk application standalone or with the additional tilting platform, which allows to adjust the inclination of the scanner to provide the most comfortable use depending on the needs.

Figure 7. Presentation Position

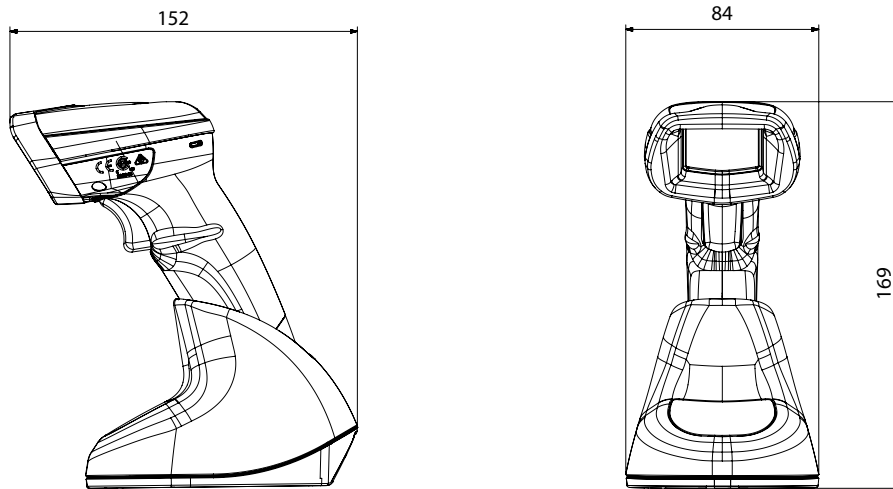

This position is preferred, if the scanner is to be used in stand mode and not needed to be often removed from base station.

Figure 8. Tilting Platform Position

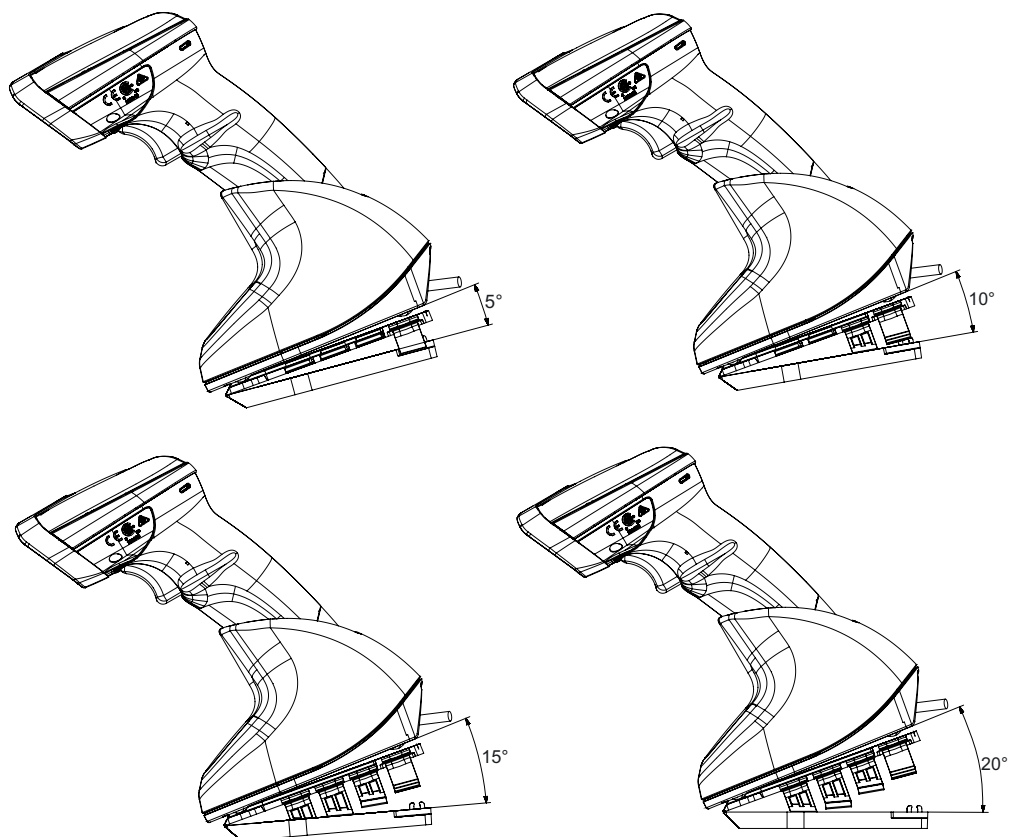

This optional tilting platform allows to adjust the scanner inclination to different angle positions.

SCANNER AND RADIO BASE LEDS

A specific LED on the QBT/QM2500 Scanner provides information about: good reading result, battery status and charging status (with USB Type-C only). The Battery Status information can be easily retrieved by double-tapping with your fingers on top of the head of the scanner. The following table and figure explain the main colors' combinations provided by the Battery Status LED.

Table 1 - Battery and Recharge LED Description

COLOR		BATTERY STATUS
Blinking color (1s ON - 1s OFF)	Green (charge = 50% - 99%) Red (charge less than 1%) NOTE: Scanner is unusable until 1% is reached	Charge in Progress through USB Type-C
Solid Green (charge = 100%)	It goes OFF when Scanner's unplugged	Charge Complete through USB Type-C
Solid color (3s time-out)	Green (charge = 50% - 100%) Amber (charge = 2% - 50%) Red blinking (charge less than 2%)	Battery Status

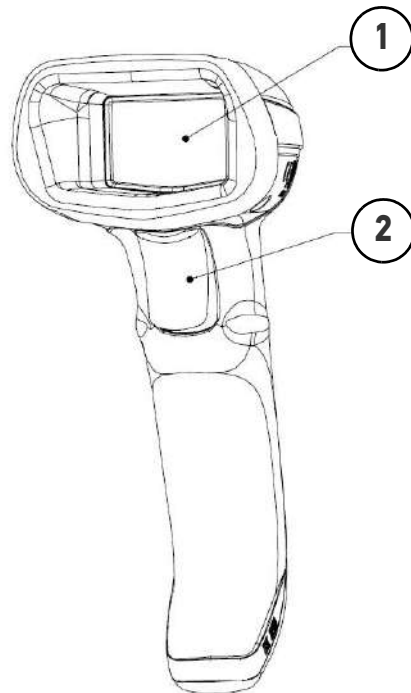

1. Scan Window
2. Trigger

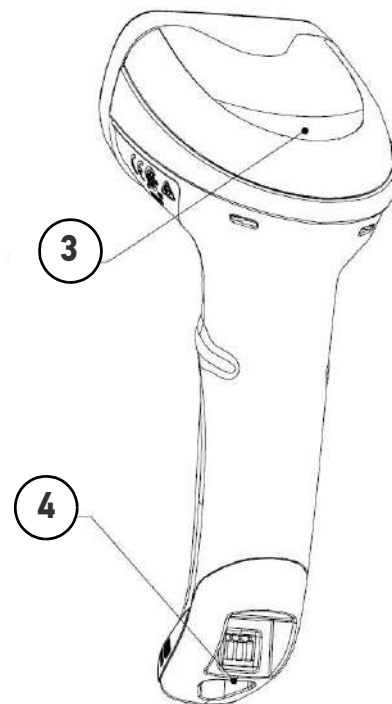

3. Battery & Recharge LED
4. USB Port

Two LEDs on the BC2090 Radio Base provide information about the Base as well as battery charging status, as illustrated in the following table:

Table 2 - Radio Base LEDs

LED		STATUS
1	Power ON / Data	Green On = Base is powered Green Blinking = Base receives data and commands from the Host or the Reader.
2	Charging	Green On = the battery is completely charged Green blinking = battery level 51 to 99% Amber blinking = battery level 1 to 50% Red blinking = pre-charge

Figure 9 - QuickScan Cradle LEDs, Communication Port and Service Button Description

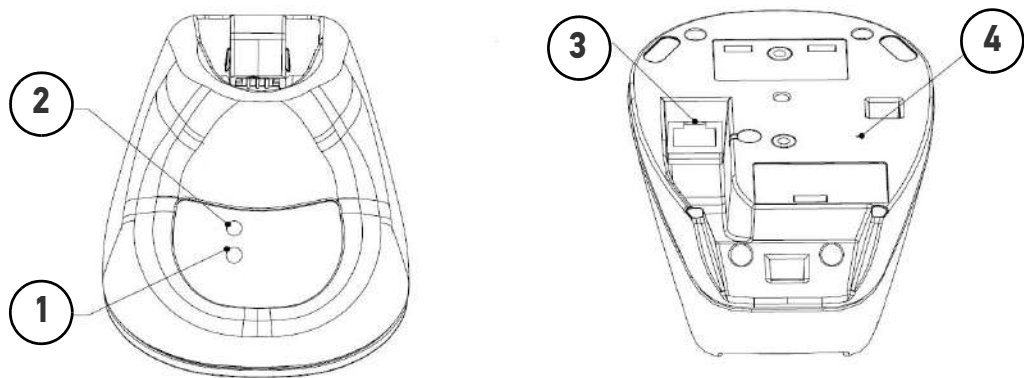

- 1. Power LED
- 2. Battery Charging Status

- 3. Communication Port
- 4. Service Button

CONNECTING THE BASE STATION

This section shows how to connect the Base Station to a terminal, PC or other host device.

Turn off the host before connection and consult the manual for that equipment (if necessary) before proceeding.



NOTE: The QuickScan™ QBT/QM2500 can also be Powered by the Terminal. For some specific interfaces or hosts or lengths of cable, the use of an external power supply is recommended for full recharging capability (See "QuickScan™ 2500 Technical Specifications" on page 292 for more details).

Base Station Connection and Routing

Fully insert the Power Cable and Interface (I/F) Cable connectors into their respective ports in the underside of the Base Station. Then connect to an AC Adapter, and plug the AC power cord into the (wall) outlet.

Figure 10. Connection to the Base Station

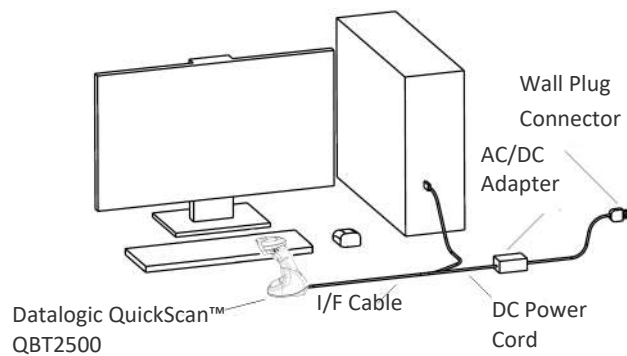

Securing the DC Power Cord (Optional)

The DC power cord for the adapter can be secured to the bottom of the base in order to maximize the mechanical retention of the cable as shown in Figure 11.

Figure 11. Option for routing the DC Cord

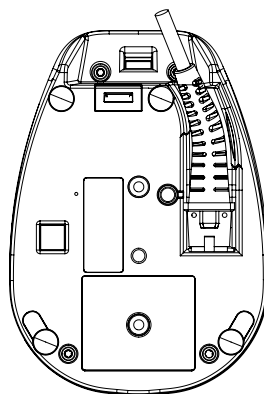

Host Connection

Verify before connection that the reader's cable type is compatible with your host equipment.

Most connections plug directly into the host device as shown in [Figure 12 on page 20](#). Keyboard Wedge interface cables have a 'Y' connection where its female end mates with the male end of the cable from the keyboard and the remaining end at the keyboard port on the terminal/PC as shown in [Figure 13 on page 20](#).

Figure 12. Connecting to the Host



Figure 13. Connecting to the Host with Keyboard Wedge.



Power Connection

Plug the AC Adapter into an approved AC wall socket with the cable facing downwards (as shown in [Figure 10 on page 19](#)) to prevent undue strain on the socket.

Disconnecting the Cable

To detach the cable, use a finger or an object to pull-down the flap, as shown below.

Figure 14. Disconnecting the Cable

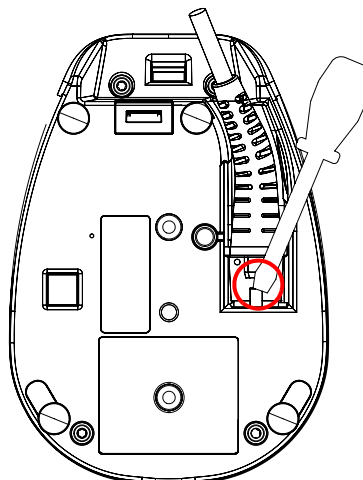

SYSTEM AND NETWORK LAYOUTS

Stand Alone Layouts

Figure 15 - Single Reader Layout

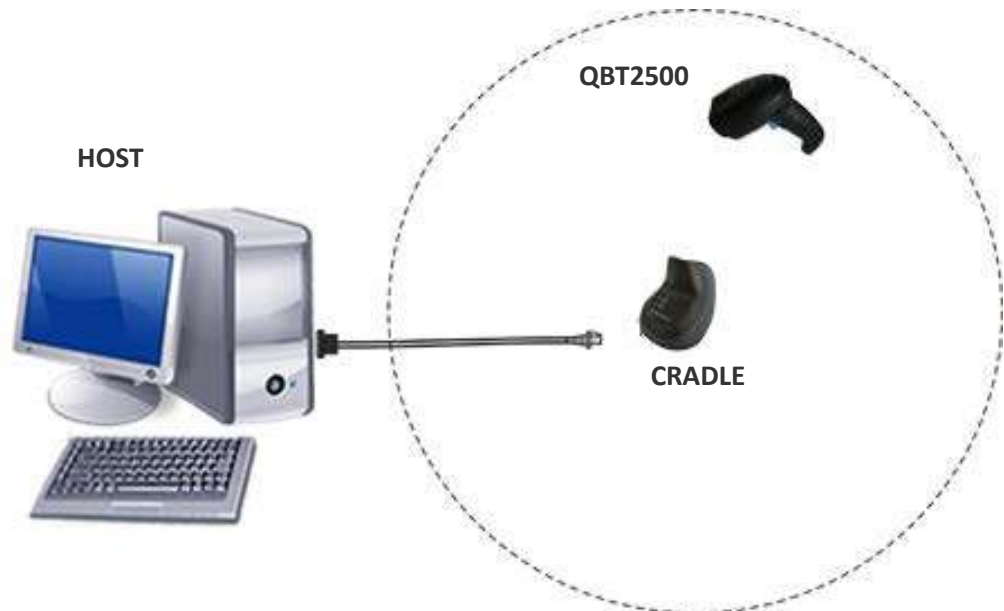
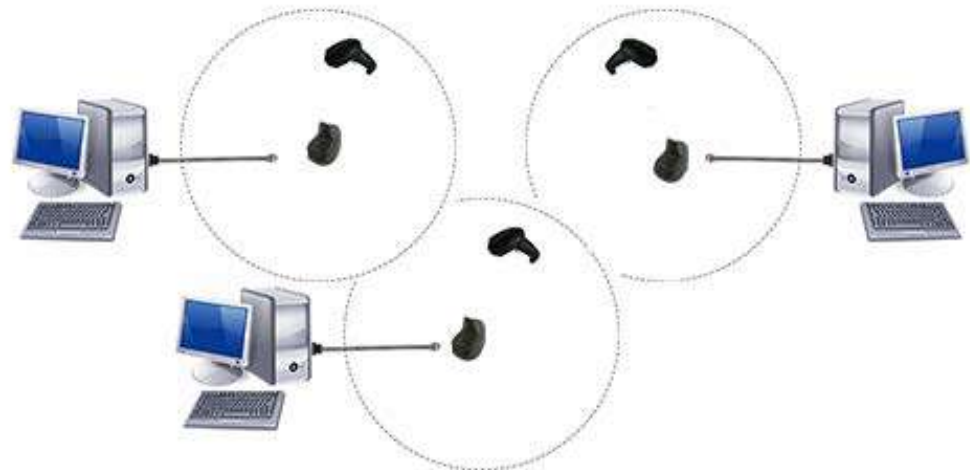

Figure 16 - Multiple Stand Alone Layout



Many stand alone connections can operate in the same physical area without interference, provided all readers and cradles in the system have different addresses.

INTERFACE SELECTION

Upon completing the physical connection between the reader and its host, proceed directly to "Configuring the Interface" on page 22 for information and programming for the interface type the scanner is connected to (for example: RS-232, Keyboard Wedge, USB, etc.) and scan the appropriate bar code in that section to select your system's correct interface type.

The reader, depending upon the model, will support one or more of the following sets of host interfaces:

- USB (Keyboard, COM, OEM)
- USB Composite (Keyboard + COM)
- USB HID POS
- USB Toshiba TEC
- RS-232 STD¹
- RS-232 WN¹
- RS232 OPOS¹
- Keyboard Wedge/IBM46XX port 9b (a specific cable is required)¹. See note at page 11.
- Datalogic Magellan Scanners' specific interface

CONFIGURING THE INTERFACE

Scan the programming bar code from the following section which selects the appropriate interface type to match the system the reader will be connected to. Next, proceed to the corresponding chapter in this manual (also listed in the table) to configure any desired settings and features associated with that interface.



NOTE: Unlike some other programming features and options, interface selections require that you scan only one programming bar code label. DO NOT scan an ENTER/EXIT bar code prior to scanning an interface selection bar code. Some interfaces require the reader to start in the disabled state when powered up. If additional reader configuration is desired while in this state, pull the trigger and hold for 5 seconds. The reader will change to a state that allows programming with bar codes.

Table 3 - Available Interfaces





USB-OEM	
 Select USB-OEM	USB-OEM (can be used for OPOS/UPOS/JavaPOS)







NOTE: If you erroneously read the USB-OEM interface selection code, it is required to press and hold the trigger to unlock the reader. Then read the correct interface bar code. This will work only at power-up. Please reconnect the reader if the unlock is not successful.





1. Not available for QW2500 and QD2520.

Table 4 - Available Interfaces (continued)

SERIAL INTERFACES	
RS-232 standard interface ^a <i>*Not supported on USB only models</i>	 Select RS232-STD
 Select RS232-WN	RS-232 Wincor-Nixdorf ^a
RS-232 for use with OPOS/UPOS/JavaPOS ^a	 Select RS-232 OPOS
 Select USB-COM-STD ^b	USB-COM (simulates RS-232 standard interface)

- a. Not available for QW2500 and QD2520.
- b. Download the correct USB Com driver from www.datalogic.com.

USB FOR TERMINALS	
USB HID POS	 Select USB HID POS
 Select USB Toshiba TEC	USB Toshiba TEC
USB FOR MAGELLAN SCANNERS	
USB for Magellans	 Select USB for Magellan Scanners
ETHERNET	
 Select Ethernet Interface	Ethernet Interface

KEYBOARD	
USB Keyboard with standard key encoding	 <p>Select USB Standard Keyboard</p>
 <p>Select USB Alternative Keyboard</p>	USB Keyboard with alternative key encoding
USB-Composite (combines USB-KBD emulation and USB-COM)	 <p>Select USB-Composite</p>
 <p>Select KBD-AT</p>	AT, PS/2 with standard key encoding ^a
AT, PS/2 with alternate key encoding ^a	 <p>Select KBD-AT-ALT</p>

a. Not available for QW2500 and QD2520.



NOTE: The Wedge interface is supported by products manufactured until June 2023.

CUSTOMIZING CONFIGURATION SETTINGS

Using the Programming Bar Codes

This manual contains feature descriptions and bar codes which allow you to reconfigure your reader. Some programming bar code labels, like [Resetting the Product Configuration to Defaults, starting on page 26](#), require only the scan of that single label to enact the change.

Most of the programming labels in this manual, however, require the reader to be placed in Programming Mode prior to scanning them. Scan an ENTER/EXIT bar code once to enter Programming Mode. Once the reader is in Programming Mode, you can scan a number of parameter settings before scanning the ENTER/EXIT bar code a second time, which will then accept your changes, exit Programming Mode and return the reader to normal operation.



NOTE: There are some exceptions to the typical programming sequence described above. Please read the description and setting instructions carefully when configuring each given programmable feature.

Datalogic Aladdin™ Utility

Programming can alternatively be performed using the Datalogic Aladdin™ Configuration application which is available for free download from the Datalogic website listed on the back cover of this manual. This multi-platform utility program allows device configuration using a PC. It communicates to the device using a serial or USB cable and can also create configuration bar codes to print.

Datalogic Aladdin™ is a multi-platform utility program providing a quick and user-friendly configuration method via the RS-232/USB-COM interface. The Aladdin utility is available on the Datalogic website. Aladdin allows you to program the reader by selecting configuration commands through a user-friendly graphical interface running on a PC. These commands are sent to the reader over the selected communication interface, or they can be printed as bar codes to be scanned.

Aladdin also provides the ability to perform a software upgrade for the connected device (see the Datalogic Aladdin™ Help On-Line for more details).

Interface Settings

The reader is typically factory-configured with a set of default features standard to the interface type you ordered. See [Appendix B, Standard Defaults](#).

Global Interface Features, starting on [page 27](#) provides settings configurable by all interface types. If your installation requires you to further customize your reader, you can select other options through use of the instructions and programming bar codes available in the appropriate section for your interface.

- ["Not available for QW2500 and QD2520" on page 30](#)
- ["RS-232/USB-COM Interfaces" on page 35](#)
- [RS232 OPOS on page 23](#)
- [USB Composite \(COM + Keyboard\) on page 24](#)
- [KEYBOARD INTERFACE on page 43](#)
- [USB-OEM INTERFACE on page 72](#)

Configuring Other Features

If your installation requires different programming than the standard factory default settings, the following sections of this manual allow configuration of non-interface-specific settings you might require:

Configuration Using Bar Codes: General Features includes programming for scanning, beeper and LED indicators and other such universal settings.

Reading Parameters: Reading Parameters include programming for scanning, beeper and LED indicators and other universal settings.

1D Symbologies: Includes options concerning the bar code label types (symbologies). These settings allow you to enable/disable symbologies, set label lengths, require check digit, etc.

Software Version Transmission

The software version of the device can be transmitted over the RS-232, Keyboard and USB interfaces by scanning the following label.



Transmit Software Version

Resetting the Product Configuration to Defaults

Restore Custom Default Configuration

If you aren't sure what programming options are in your reader, or you've changed some options and want to restore the Custom Default Configuration that may have been saved in the reader, scan the Restore Custom Default Configuration bar code below. This will restore the custom configuration for the currently active interface.



NOTE: Custom defaults are based on the interface type. Configure the reader for the correct interface before scanning this label.



Restore Custom Default Configuration

Restore Factory Configuration

If you want to restore the Factory Configuration for your reader, scan either the Restore USA Factory Configuration bar code or the Restore EU Factory Configuration bar code below. Both labels restore the reader configuration to the factory settings, including the interface type. The USA label restores Label IDs to those historically used in the USA. The EU label restores Label IDs to those historically used in Europe. The Label ID sets for USA and EU are shown in the "Label ID" Section on [page 81](#) of this manual.



Restore USA Factory Configuration



Restore EU Factory Configuration

The programming items listed in the following sections show the factory default settings for each of the menu commands.

CHAPTER 3

CONFIGURATION WITH BAR CODES

This and following sections provide programming bar codes to configure your reader by changing the default settings. For details about additional methods of programming, see "Customizing Configuration Settings" on page 24.



NOTE: You must first enable your QuickScan to read bar codes in order to use this section. If you have not done this, go to Setup, starting on page 9 and complete the appropriate procedure.

CONFIGURATION PARAMETERS

Once the reader is set up, you can change the default parameters to meet your application needs. Refer to [Standard Defaults, starting on page 307](#) for initial configuration in order to set the default values and select the interface for your application.



NOTE: In the following sections, text shown with a green star indicates a factory default value.

★ This is an example of a default value.

The following configuration parameters are divided into logical groups, making it easy to find the desired function based on its reference group.

Interface Configuration:

- [RS-232 Standard Settings, starting on page 31](#)
- [RS-232/USB-COM Settings, starting on page 36](#)
- [Keyboard Interface, starting on page 43](#)
- [USB-OEM Interface, starting on page 72](#)

Parameters common to all interface applications:

- [Global Prefix/Suffix, starting on page 77](#)
- [Data Format, starting on page 76](#) gives options to control the messages sent to the Host system by selecting parameters to control the message strings sent to the handheld.
- [Reading Parameters, starting on page 87](#) controls various operating modes and indicators status functioning.

Symbology-specific parameters:

1D Symbologies, starting on page 111 and 2D Symbologies, starting on page 196 define options for all symbologies and provides the programming bar codes necessary for configuring these features.



NOTE: You must first enable your reader to read bar codes in order to use this section. If you have not done this, go to Setup, starting on page 9 and complete the appropriate procedure.

To program features:

1. Scan the ENTER/EXIT PROGRAMMING bar code, available at the top of each programming page, when applicable.
2. Scan the bar code to set the desired programming feature. You may need to cover unused bar codes on the page, and possibly the facing page, to ensure that the reader reads only the bar code you intend to scan.
3. If additional input parameters are needed, go to [Appendix D](#), and scan the appropriate characters from the keypad.



NOTE: Additional information about many features can be found in the References, starting on page 260.

If you make a mistake before the last character, scan the CANCEL bar code to abort and not save the entry string. You can then start again at the beginning.

4. Complete the programming sequence by scanning the ENTER/EXIT PROGRAMMING bar code to exit Programming Mode.

For more detailed descriptions, programming information and examples for setting selected configuration items, see [References, starting on page 260](#).



GLOBAL INTERFACE FEATURES

The following interface features are configurable by all interface types.

To set features specific to your interface, turn to that section of this manual.

Host Commands — Obey/Ignore

This option specifies whether the reader will obey or ignore host commands. When set to ignore, the reader will ignore all host commands except those necessary for:

- service mode
- flash programming mode
- keeping the interface active
- transmission of labels.



★ Host Commands = Obey
(Do Not Ignore Host Commands)



Host Commands = Ignore

USB Suspend Mode

This setting enables/disables the ability of USB interfaces to enter suspend mode.



USB Suspend Mode = Disable



★ USB Suspend Mode = Enable

CONFIGURATION | RS-232 INTERFACE

Not available for QW2500 and QD2520

Use the programming bar codes in this chapter if modifications to the standard RS-232 interface settings are necessary to meet your system's requirements. Additional settings which apply to both the RS-232 and USB interfaces are available in [RS-232/USB-COM Settings](#), starting on page 36.

SECTION CONTENTS

RS-232 STANDARD SETTINGS starting on page 31

- Baud Rate
- Data Bits
- Stop Bits
- Parity
- Handshaking Control

Standard Factory Settings

Reference [Appendix B](#), for a listing of standard factory settings.



RS-232 STANDARD SETTINGS

Baud Rate

Baud rate is the number of bits of data transmitted per second. Set the reader's baud rate to match the baud rate setting of the host device. With an improper baud rate setting, data may not reach the host correctly.



Baud Rate = 1200



Baud Rate = 2400



Baud Rate = 4800



★ Baud Rate = 9600



Baud Rate = 19,200



Baud Rate = 38,400



Baud Rate = 57,600



Baud Rate = 115,200



Data Bits

This parameter allows the reader to interface with devices requiring a 7-bit or 8-bit ASCII protocol for sending and receiving data.



7 Data Bits



★ 8 Data Bits



NOTE: Handheld and base station models support the 8-bit ASCII protocol. The 7-bit ASCII protocol support is subject to specific firmware release. If the setting is not supported, the reader will emit three short beeps upon scanning the label.

Stop Bits

The stop bit(s) at the end of each transmitted character marks the end of transmission of one character and prepares the receiving device for the next character in the serial data stream. The number of stop bits selected (one or two) depends on the number the receiving terminal is programmed to accommodate. Set the number of stop bits to match host device requirements..



★ 1 Stop Bit



2 Stop Bits



Parity

This feature specifies parity required for sending and receiving data. A parity check bit is the most significant bit of each ASCII coded character. Select the parity type according to host device requirements.

- Select None when no parity bit is required.
- Select Odd parity and the parity bit value is set to 0 or 1, based on data, to ensure that an odd number of 1 bits are contained in the coded character.
- Select Even parity and the parity bit value is set to 0 or 1, based on data, to ensure that an even number of 1 bits are contained in the coded character.



★ Parity = None



Parity = Even



Parity = Odd



Handshaking Control

The data interface consists of an RS-232 port designed to operate either with or without the hardware handshaking lines, Request to Send (RTS), and Clear to Send (CTS). Handshaking Control includes the following options:

- RTS — RTS is asserted during transmissions. CTS is ignored.
- RTS/CTS — RTS is asserted during transmissions. CTS gates transmissions.
- RTS/XON/XOFF — RTS is asserted during transmissions. CTS is ignored. XON and XOFF gate transmissions.
- RTS On/CTS — RTS is always asserted. CTS gates transmissions.
- RTS/CTS Scan Control — RTS is asserted during transmissions. CTS gates transmissions and controls enable and disable state of reader.



★ Handshaking Control = RTS



Handshaking Control = RTS/CTS



Handshaking Control = RTS/XON/XOFF



Handshaking Control = RTS On/CTS



Handshaking Control = RTS/CTS Scan Control



Handshaking Control = RTS Off

CONFIGURATION | RS-232/USB-COM INTERFACES

SECTION CONTENTS	
<ul style="list-style-type: none">• Intercharacter Delay• Beep On ASCII BEL• Beep On Not on File• ACK NAK Options• ACK Character• NAK Character	<ul style="list-style-type: none">• ACK NAK Timeout Value• ACK NAK Retry Count• ACK NAK Error Handling• Indicate Transmission Failure• Disable Character• Enable Character

Standard Factory Settings

Reference [Appendix B](#), for a listing of standard factory settings.



RS-232/USB-COM SETTINGS

Intercharacter Delay

This parameter specifies the intercharacter delay between the end of one character and the beginning of the next. The delay can be set within a range of zero (0) to 990 milliseconds in 10ms increments. A setting of zero specifies no delay. See "[Intercharacter Delay](#)" on [page 262](#) for more detailed programming instructions.



Intercharacter Delay = No Delay



Select Intercharacter Delay Setting

To configure this feature, scan the ENTER/EXIT bar code above, then the bar code at left followed by digits from the Alphanumeric characters in [Appendix D](#) representing your desired character(s). End by scanning the ENTER/EXIT bar code again.

Make a mistake? Scan the CANCEL bar code to abort and not save the entry string. You can then start again at the beginning.



CANCEL

★00 = No Intercharacter Delay



Beep On ASCII BEL

When this parameter is enabled, the reader issues a beep when a <BEL> character is detected on the RS-232 serial line. <BEL> is issued to gain a user's attention to an illegal entry or other important event.



★ Beep On ASCII BEL = Disable



Beep On ASCII BEL = Enable

Beep On Not on File

This option enables/disables the action of the reader to sound a three beep sequence upon receiving a Not-On-File (NOF) host command.



Beep On Not On File = Disable



★ Beep On Not On File = Enable



ACK NAK Options

This enables/disables the ability of the reader to support the RS-232 ACK/NAK protocol. When configured, the reader and/or host sends an “ACK” when it receives data properly, and sends “NAK” when the data is in error.

Options are:

- Disable
- Enable for label transmission — The reader expects an ACK/NAK response from the host when a label is sent.
- Enable for host-command acknowledge — The reader will respond with ACK/NAK when the host sends a command.
- Enable for label transmission and host-command acknowledge



★ ACK/NAK Protocol = Disable ACK/NAK



ACK/NAK Protocol = Enable for label transmission



ACK/NAK Protocol = Enable for host-command
acknowledge



ACK/NAK Protocol = Enable for label transmission and
host command acknowledge



ACK Character

This setting specifies an ASCII character or hex value to be used as the ACK character. ASCII characters or any hex value from 0 to 0xFF can be selected. See "ACK Character" on page 263 for more detailed programming instructions.



NOTE: Setting to previously defined characters such as XON, XOFF, or host commands conflicts with normal operation of these characters. 8-bit data is not recognized when the option "Data Bits" on page 32 has been set as 7 Data Bits.



Select ACK Character Setting

Make a mistake? Scan the CANCEL bar code to abort and not save the entry string. You can then start again at the beginning.



CANCEL

★ 0x06 'ACK' Character

NAK Character

This setting specifies an ASCII character or hex value to be used as the NAK character. ASCII characters or any hex value from 0 to 0xFF can be selected. See "NAK Character" on page 264 for more detailed programming instructions.



NOTE: Setting to previously defined characters such as XON, XOFF, or host commands conflicts with normal operation of these characters. 8-bit data is not recognized when the option "Data Bits" on page 32 has been set as 7 Data Bits.



Select NAK Character Setting

Make a mistake? Scan the CANCEL bar code to abort and not save the entry string. You can then start again at the beginning.



CANCEL

★ 0x15 'NAK' Character



ACK NAK Timeout Value

This option specifies the amount of time the reader waits for an ACK character from the host following label transmission. The selectable timeout range is 200 milliseconds to 15,000ms (15 seconds) in 200ms increments. A selection of 0 disables the timeout. See "[ACK NAK Timeout Value](#)" on page 265 for more detailed programming instructions.



Select ACK NAK Timeout Value Setting

To configure this feature, scan the ENTER/EXIT bar code above, then the bar code at left followed by digits from the Alphanumeric characters in [Appendix D](#) representing your desired character(s). End by scanning the ENTER/EXIT bar code again.

Make a mistake? Scan the CANCEL bar code to abort and not save the entry string. You can then start again at the beginning.



CANCEL

★01 ACK NAK Timeout value is 200ms

ACK NAK Retry Count

This feature specifies the number of times the reader retries a label transmission due to a retry condition. The selectable range is from 1 to 254 retries. A selection of 0 disables the count, and a selection of 255 specifies unlimited retries. See "[ACK NAK Retry Count](#)" on page 266 for more detailed programming instructions.



Select ACK NAK Retry Count Setting

To configure this feature, scan the ENTER/EXIT bar code above, then the bar code at left followed by digits from the Alphanumeric characters in [Appendix D](#) representing your desired character(s). End by scanning the ENTER/EXIT bar code again.

Make a mistake? Scan the CANCEL bar code to abort and not save the entry string. You can then start again at the beginning.



CANCEL

★003 = 3 Retries



ACK NAK Error Handling

This feature specifies the method the reader uses to handle receive errors detected while waiting for an ACK character from the host.

Options are:

- Ignore errors detected
- Process error as valid ACK character
- Process error as valid NAK character



★ ACK NAK Error Handling = Ignore Errors Detected



ACK NAK Error Handling = Process Error as
Valid ACK Character



ACK NAK Error Handling = Process Error as
Valid NAK Character

Indicate Transmission Failure

This option enables/disables the reader's ability to sound an error beep to indicate a transmission failure while in ACK/NAK mode.



Indicate Transmission Failure = Disable Indication



★ Indicate Transmission Failure = Enable Indication



Disable Character

Specifies the value of the RS-232 host command used to disable the reader. ASCII characters or any hex value from 0 to 0xFF can be selected. See "Disable Character" on page 267 for more detailed programming instructions.



Setting to previously defined characters such as XON, XOFF, or host commands conflicts with normal operation of these characters.



Select Disable Character Setting

Make a mistake? Scan the CANCEL bar code to abort and not save the entry string. You can then start again at the beginning.



CANCEL

★ 0x44 = Disable Character is 'D'

Enable Character

Specifies the value of the RS-232 host command used to enable the reader. ASCII characters or any hex value from 0 to 0xFF can be selected. See "Enable Character" on page 268 for more detailed programming instructions.



Setting to previously defined characters such as XON, XOFF, or host commands conflicts with normal operation of these characters.



Select Enable Character Setting

Make a mistake? Scan the CANCEL bar code to abort and not save the entry string. You can then start again at the beginning.



CANCEL

★ 0x45 = Enable Character is 'E'

CONFIGURATION | KEYBOARD INTERFACE

SECTION CONTENTS

COUNTRY MODE starting on page 44

- Setting Country Mode

OTHER KEYBOARD PARAMETERS starting on page 59

- Encoding Type
- ALT Output Type
- Caps Lock State
- Numlock
- Keyboard Numeric Keypad
- Keyboard Send Control Characters
- Wedge Quiet Interval
- Intercharacter Delay
- Intercode Delay
- USB Keyboard Speed

Use the programming bar codes in this chapter to select options for USB Keyboard and Wedge Interfaces. Reference [Appendix B](#), for a listing of standard factory settings. Information about control character emulation which applies to keyboard interfaces is listed in [Appendix E](#), Scancode Tables.

COUNTRY MODE

This feature specifies the country/language supported by the keyboard.

The Country Mode setting is ignored if the interface uses alternate key encoding.

SETUP ON PC TO USE ALT UNIVERSAL

1. Open Registry Edit

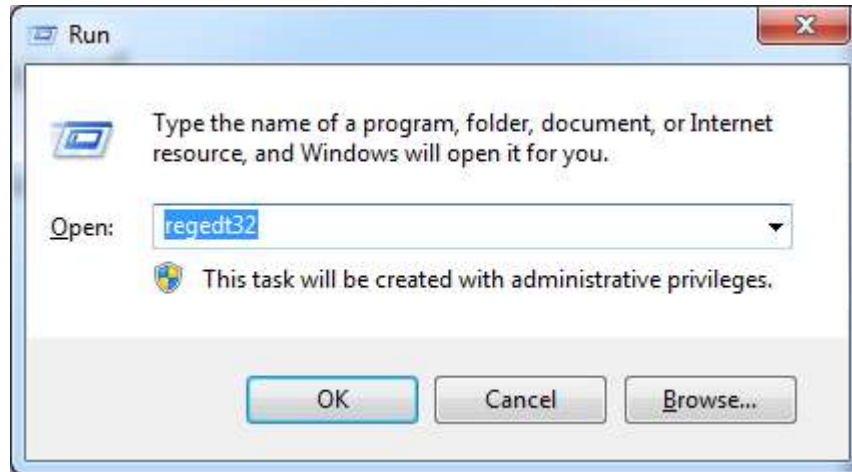

2. Set EnableHexNumpad to 1 as follows:

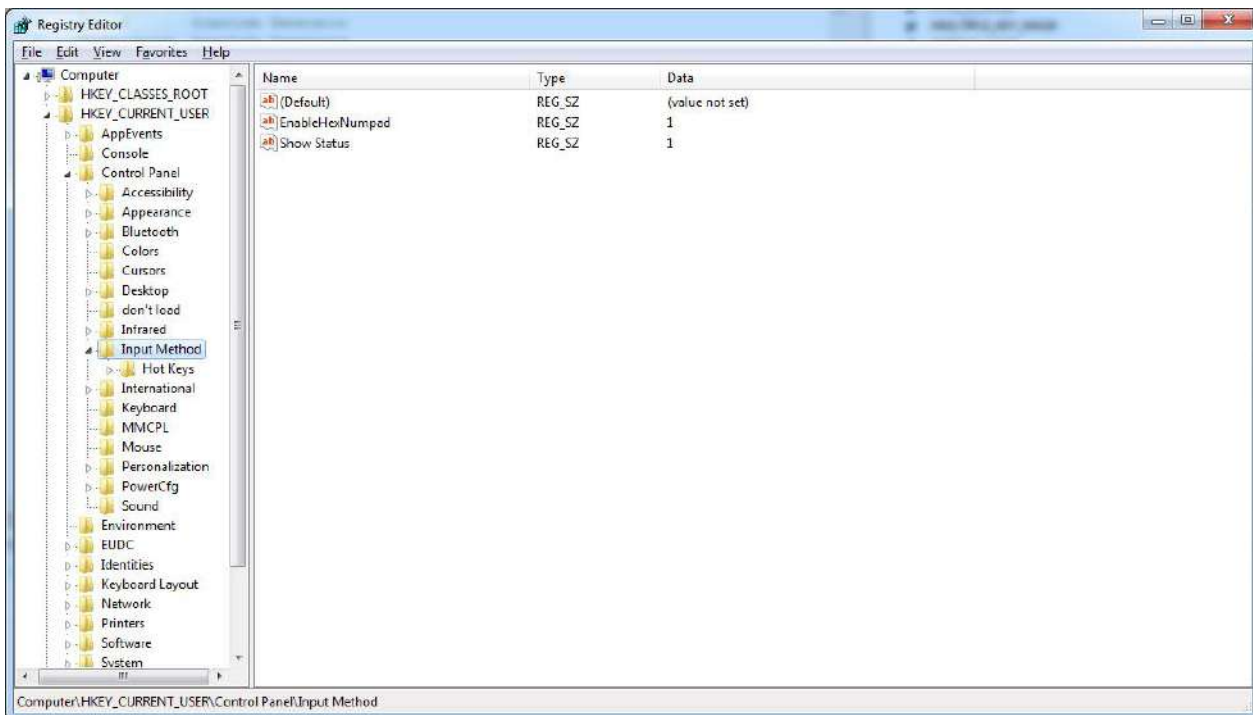

3. Reset the PC.



Setting Country Mode



★ United States



French International (Belgian French)



United Kingdom



Danish



French (France)



German



Italian



Setting Country Mode (continued)



Norwegian



Portuguese (Portugal)



Spanish



Swedish



Swiss French



Japanese ASCII



Hungarian



Setting Country Mode (continued)



Czech



Slovak



Romanian



Croatian



Polish_214



French Canadian Win7



Lithuanian



Setting Country Mode (continued)



Vietnamese



Russian



Arabic 101



Chinese ASCII



Thai-Kedmanee



Albanian



Arabic 102



Setting Country Mode (continued)



Arabic 102 AZERTY



Azeri Cyrillic



Azeri Latin



Belarusian



Bosnian Cyrillic



Bosnian Latin



Bulgarian Cyrillic



Setting Country Mode (continued)



Bulgarian Latin



Canadian French (Legacy)



Canadian Multilingual



Chinese (Simplified)



Chinese (Traditional)



Czech Programmers



Czech QWERTY



Setting Country Mode (continued)



Dutch Netherland



Estonian



Faeroese



Finnish



French (Canada) 2000/XP



French (Canada) 95/98



Galician



Setting Country Mode (continued)



Greek



Greek Latin



Greek Polytonic



Greek220



Greek220 Latin



Greek319



Greek319 Latin



Setting Country Mode (continued)



Hebrew Israel



Hungarian_101KEY



Icelandic



Irish



Italian_142



Japanese (Shift-JIS)



Kazakh



Setting Country Mode (continued)



Korean (Hangul)



Korean ASCII



Kyrgyz Cyrillic



Latin America



Latvian



Latvian QWERTY



Lithuanian_IBM



Setting Country Mode (continued)



Macedonian -FYROM



Maltese_47KEY



Mongolian-Cyrillic



Polish Programmer



Portuguese Brazil



Portuguese Brazilian ABNT



Portuguese Brazilian ABNT2



Setting Country Mode (continued)



Romanian Legacy



Romanian Programmer



Romanian Standard



Russian Typewriter



Serbian Cyrillic



Serbian Latin



Slovak QWERTY



Setting Country Mode (continued)



Slovenian



Spanish Variation



Swiss German



Tatar



Turkish F



Turkish Q



Ukrainian



Setting Country Mode (continued)



US Dvorak



US Dvorak Left Hand



US Dvorak Right Hand



US English (Mac)



US English (North American)



US International



Uzbek Cyrillic



OTHER KEYBOARD PARAMETERS

Encoding Type



★ Encoding Type = Don't Use Encoding



Encoding Type = UTF_8



Encoding Type = Windows 874



Encoding Type = Windows 932



Encoding Type = Windows 936



Encoding Type = Windows 949



Encoding Type = Windows 950



Encoding Type (continued)



Encoding Type = Windows 1250



Encoding Type = Windows 1251



Encoding Type = Windows 1252



Encoding Type = Windows 1253



Encoding Type = Windows 1254



Encoding Type = Windows 1255



Encoding Type = Windows 1256



Encoding Type (continued)



Encoding Type = Windows 1257



Encoding Type = Windows 1258



Encoding Type = Windows 20866



Encoding Type = Windows 54936



Encoding Type = ISO 8859-1



Encoding Type = ISO 8859-2



Encoding Type = ISO 8859-3



Encoding Type (continued)



Encoding Type = ISO 8859-4



Encoding Type = ISO 8859-5



Encoding Type = ISO 8859-6



Encoding Type = ISO 8859-7



Encoding Type = ISO 8859-8



Encoding Type = ISO 8859-9



Encoding Type = ISO 8859-10



Encoding Type (continued)



Encoding Type = ISO 8859-11



Encoding Type = ISO 8859-13



Encoding Type = ISO 8859-14



Encoding Type = ISO 8859-15



Encoding Type = ISO 8859-16



Encoding Type = MS-DOS 437



Encoding Type = MS-DOS 737



Encoding Type (continued)



Encoding Type = MS-DOS 775



Encoding Type = MS-DOS 850



Encoding Type = MS-DOS 852



Encoding Type = MS-DOS 855



Encoding Type = MS-DOS 857



Encoding Type = MS-DOS 860



Encoding Type = MS-DOS 861



Encoding Type (continued)



Encoding Type = MS-DOS 862



Encoding Type = MS-DOS 863



Encoding Type = MS-DOS 865



Encoding Type = MS-DOS 866



Encoding Type = MS-DOS 869



Encoding Type = Mac CP10000



ALT Output Type

This option specifies the encode type of ALT Mode when the reader sends Output Keyboard Data in Alt Mode. (Be aware that the reader may switch automatically between ALT mode & Normal Keyboard Scancode, to correctly display some characters that are not present in the current Keyboard Country).



ALT Output Type = ALT Codepage
(use on non Unicode application: Notepad)



★ ALT Output Type = ALT Unicode
(use on Unicode application: Word)



ALT Output Type = ALT Universal
(Use for all)



ALT Output Type = ALT Unicode for Linux



Caps Lock State

This option specifies the format in which the reader sends character data. This applies to Keyboard Wedge interfaces. This does not apply when an alternate key encoding keyboard is selected. This does not apply to USB Keyboard.



★ Caps Lock State = Caps Lock OFF



Caps Lock State = Caps Lock ON



Caps Lock State = AUTO Caps Lock Enable

Numlock

This option specifies the setting of the Numbers Lock (Numlock) key while in Keyboard Wedge interface. This only applies to alternate key encoding interfaces. It does not apply to USB Keyboard.



★ Numlock = Numlock key unchanged



Numlock = Numlock key toggled



Keyboard Numeric Keypad

This feature specifies if numeric characters will be sent using the standard keys or the numeric keypad.



★ Keyboard Numeric Keypad = Standard Keys



Keyboard Numeric Keypad = Numeric Keypad

Keyboard Send Control Characters

This feature is used by the Keyboard Wedge and USB Keyboard interfaces. It specifies how the reader transmits ASCII control characters to the host. Reference [Appendix E Scancode Tables](#) for more information about control characters.

Options are as follows:

Send Ctrl+Key : ASCII characters from 00H to 0x1FH inclusive are transmitted in the format Ctrl+Key. Special keys are available in the range from 81H to A1.

Send Ctrl+Shift+Key : The behavior is the same as above, but control keys are sent in the format Ctrl+Shift+Keys.

Send Special Function Key : Send characters between 00H and 1FH according to the special function key mapping table (see "[Interface Type PC AT PS/2 Alt Mode or USB-Keyboard Alt Mode](#)" on page 332). This is used to send keys that are not in the normal ASCII set. A unique set is provided for each available scancode set.



★ Keyboard Send Control Characters = Send Ctrl+Key



Keyboard Send Control Characters = Send Ctrl+Shift+Key



Keyboard Send Control Characters = Send Special Function Key



Wedge Quiet Interval

This option specifies the amount of time to look for keyboard activity before the reader breaks the keyboard connection in order to transmit data to host. The selectable range for this feature is from 0 to 990ms in 10ms increments. See "[Wedge Quiet Interval](#)" on [page 269](#) for more detailed programming instructions.



NOTE: This feature applies ONLY to the Keyboard Wedge interface.



Select Wedge Quiet Interval Setting

To configure this feature, scan the ENTER/EXIT bar code above, then the bar code at left followed by digits from the Alphanumeric characters in [Appendix D](#), Keypad representing your desired character(s). End by scanning the ENTER/EXIT bar code again.

Make a mistake? Scan the CANCEL bar code to abort and not save the entry string. You can then start again at the beginning.



CANCEL

★10 = Quiet Interval of 100 msec

Intercharacter Delay

This parameter specifies the intercharacter delay between the end of one character and the beginning of the next. The delay can be set within a range of zero (0) to 990 milliseconds in 10ms increments. A setting of zero specifies no delay. See "[Intercharacter Delay](#)" on [page 270](#) for more detailed programming instructions.



Intercharacter Delay = No Delay



Select Intercharacter Delay Setting

To configure this feature, scan the ENTER/EXIT bar code above, then the bar code at left followed by digits from the Alphanumeric characters in [Appendix D](#), Keypad representing your desired character(s). End by scanning the ENTER/EXIT bar code again.

Make a mistake? Scan the CANCEL bar code to abort and not save the entry string. You can then start again at the beginning.



CANCEL

★00 = No Intercharacter Delay



Intercode Delay

Specifies the delay between labels transmitted to the host for this interface. The selectable range for this feature is from 0 to 99 seconds. See "[Intercode Delay](#)" on page 271 for more detailed programming instructions



Set Intercode Delay

To configure this feature, scan the ENTER/EXIT PROGRAMMING MODE bar code above, then the bar code at left followed by the digits from the Alphanumeric characters in [Appendix D, Keypad](#) representing your desired character(s). End by scanning the ENTER/EXIT bar code again.

Make a mistake? Scan the CANCEL bar code to abort and not save the entry string. You can then start again at the beginning.



CANCEL

★00 = No Wedge Intercode Delay



USB Keyboard Speed

This option specifies the USB poll rate for a USB Keyboard.



NOTE: This feature applies ONLY to the USB Keyboard interface.



★ USB Keyboard Speed = 1ms



USB Keyboard Speed = 2ms



USB Keyboard Speed = 3ms



USB Keyboard Speed = 5ms



USB Keyboard Speed = 7ms



USB Keyboard Speed = 10ms

CONFIGURATION | USB-OEM INTERFACE

SECTION CONTENTS

- USB-OEM Device Usage



USB-OEM Device Usage

The USB-OEM protocol allows for the reader to be identified as one of two different types of bar code reader. Depending on what other reader you may already have connected to a USB-OEM POS, you may need to change this setting to enable all devices to communicate.

Options are:

- Tabletop Scanner
- Handheld Scanner



NOTE: This feature is not compatible with Multiple Labels Reading in a Volume.



USB-OEM Device Usage = Tabletop Scanner



★ USB-OEM Device Usage = Handheld Scanner

CONFIGURATION | IBM 46XX INTERFACE

Not available for QW2500 and QD2520

SECTION CONTENTS

- IBM 46xx Interface Options



IBM 46xx Interface Options

This setting provides for an interface specific control mechanism.

Options are:

- Obey — Obey Scanner Configuration Host Commands
- Ignore — Ignore Scanner Configuration Host Commands



★ Interface Options = Obey Scanner Configuration
Host Commands



Interface Options = Ignore Scanner Configuration
Host Commands

CONFIGURATION | DATA FORMAT

SECTION CONTENTS

GLOBAL SETTINGS starting on page 77

- Global Prefix/Suffix
- Case Conversion
- Character Conversion
- Global AIM ID
- GS1-128 AIM ID

LABEL ID starting on page 80

- Label ID: Set Individually Per Symbology
- Label ID Control
- Label ID Symbology Selection



GLOBAL SETTINGS

Global Prefix/Suffix

Up to 20 ASCII characters may be added as a prefix (in a position before the bar code data) and/or as a suffix (in a position following the bar code data). See [page 273](#) in “References” for more detailed programming instructions.

To configure, scan the ENTER/EXIT PROGRAMMING MODE bar code above, then the bar code at left followed by the digits from the Alphanumeric characters in [Appendix D, Keypad](#) representing your desired character(s). End by scanning the ENTER/EXIT bar code.



Set Global Prefix



Set Global Suffix

To configure, scan the ENTER/EXIT PROGRAMMING MODE bar code above, then the bar code at left followed by the digits from the Alphanumeric characters in [Appendix D, Keypad](#) representing your desired character(s). End by scanning the ENTER/EXIT bar code.

Make a mistake? Scan the CANCEL bar code to abort and not save the entry string. You can then start again at the beginning.



CANCEL

★ No Global Prefix

★ Global Suffix = Global Suffix = 0x0D(CR)



Case Conversion

This feature allows conversion of the case of all alphabetic characters to upper or lower case.



NOTE: Case conversion affects ONLY scanned bar code data, and does not affect Label ID, Prefix, Suffix, or other appended data.



★ Case Conversion = Disable (no case conversion)



Case Conversion = Convert to upper case



Case Conversion = Convert to lower case

Character Conversion

Character conversion is an eight byte configuration item. The eight bytes are 4 character pairs represented in hexadecimal ASCII values. The first character in the pair is the character that will be converted. The second character in the pair is the character to convert to. If the character to convert in a pair is FF, then no conversion is done. See [page 279](#) in “References” for more detailed programming instructions.



Configure Character Conversion

To configure, scan the ENTER/EXIT PROGRAMMING MODE bar code above, then the bar code at left followed by the digits from the Alphanumeric characters in [Appendix D, Keypad](#) representing your desired character(s). End by scanning the ENTER/EXIT bar code.

Make a mistake? Scan the CANCEL bar code to abort and not save the entry string. You can then start again at the beginning.



CANCEL

★ 0xFFFFFFFFFFFFFFF
(no character conversion)



Global AIM ID



NOTE: This feature enables/disables addition of AIM IDs for all symbology types.

AIM label identifiers (as opposed to custom characters you select yourself as with label identifiers) can be included with scanned bar code data. See for more detailed programming instructions.



★ Global AIM ID = Disable



Global AIM ID = Enable

GS1-128 AIM ID

If Global AIM ID is disabled, the AIM ID for GS1-128 can be enabled/disabled independently. The AIM ID for GS1-128 is a]C1,]C2.

AIM IDs for other symbologies can be enabled/disabled independently as well. Contact Customer Support for assistance.



GS1-128 AIM ID = Disable



★ GS1-128 AIM ID = Enable



LABEL ID

A Label ID is a customizable code of up to three ASCII characters (each can be one of hex 0x01-0xFF), used to identify a bar code (symbology) type. It can be appended previous to or following the transmitted bar code data depending upon how this option is enabled. This feature provides options for configuring custom Label IDs as a pre-loaded set (see [Label ID: Pre-loaded Sets](#) below) or individually per symbology (see "[Label ID: Set Individually Per Symbology](#)" on page 81). If you wish to program the reader to always include an industry standard label identifier for ALL symbology types, see the previous feature "[Global AIM ID](#)" on page 79.

Label ID: Pre-loaded Sets

The reader supports two pre-loaded sets of Label IDs, the USA set and the EU set. See "[Label ID: Pre-loaded Sets](#)" on page 275 for more information concerning the pre-loaded sets that are provided.



CAUTION: When changing from one Label ID set to another, all other reader configuration settings, including the host interface type, will be erased and set to the factory defaults. Any custom configuration or custom defaults will be lost.



★ Label ID Pre-loaded Set = USA Set



Label ID Pre-loaded Set = EU Set



Label ID: Set Individually Per Symbology

This feature configures a Label ID individually for a single symbology.



NOTE: This setting requires the scanning of bar codes from multiple sections. See "Label ID: Set Individually Per Symbology" on page 277 for more detailed programming instructions.

Label ID Control

This option controls whether a Label ID is disabled, or sent as a prefix or suffix for a given symbology type.



★ Label ID Transmission = Disable



Label ID Transmission = Enable as Prefix



Label ID Transmission = Enable as Suffix



Label ID Symbology Selection

This option selects the symbology for which a Label ID is to be configured. See "[Label ID: Set Individually Per Symbology](#)" on page 277 for full instructions.

Make a mistake? Scan the CANCEL bar code to abort and not save the entry string. You can then start again at the beginning.



CANCEL



Set UPC-A Label ID Character(s)



Set UPC-A/P2 Label ID Character(s)



Set UPC-A/P5 Label ID Character(s)



Set UPC-E Label ID Character(s)



Set UPC-E/P2 Label ID Character(s)



Set UPC-E/P5 Label ID Character(s)



Set EAN-13 Label ID Character(s)



Label ID Symbology Selection (continued)



Set EAN-13/P2 Label ID Character(s)



Set EAN-13/P5 Label ID Character(s)



Set ISBN Label ID Character(s)



Set ISSN Label ID Character(s)



Set EAN-8 Label ID Character(s)



Set EAN-8 P2 Label ID Character(s)



Set EAN-8 P5 Label ID Character(s)



Set GS1 DataBar Omnidirectional Label ID Character(s)



Label ID Symbology Selection (continued)



Set GS1 DataBar Expanded Label ID Character(s)



Set GS1 DataBar Limited Label ID Character(s)



Set Code 39 Label ID Character(s)



Set Code 32 Label ID Character(s)



Set Code 39 CIP HR Label ID Character(s)



Set Code 128 Label ID Character(s)



Set Code GS1-128 Label ID Character(s)



Set Interleaved 2 of 5 Label ID Character(s)



Label ID Symbology Selection (continued)



Set Interleaved 2 of 5 CIP HR Label ID Character(s)



Datalogic 2 of 5 Label ID Character(s)



Standard 2 of 5 Label ID Character(s)



Industrial 2 of 5 Label ID Character(s)



IATA Label ID Character(s)



Codabar Label ID Character(s)



ABC Codabar Label ID Character(s)



ISBT 128 Label ID Character(s)
(single and concatenated)



Label ID Symbology Selection (continued)



Code 11 Label ID Character(s)



MSI Label ID Character(s)



Plessey Label ID Character(s)



Anker Plessey Label ID Character(s)



Set Matrix 2 of 5 Label ID Character(s)

CONFIGURATION | READING PARAMETERS

SECTION CONTENTS

SCANNING FEATURES starting on page 88

- Scan Mode
- Scanning Active Time
- Flash On Time
- Flash Off Time
- Double Read Timeout
- Stand /Base Detection Behavior (QuickScan™ QD2500 only)
- Stand Mode/Object Detection Indication (Stand Mode Flash)
- Stand Mode/Object Detection Sensitivity
- Stand Mode/Object Detection Illumination Off Time
- Corded Stand Mode
- Dock Detection Beep

LED AND BEEPER INDICATORS starting on page 96

- Power On Alert
- Good Read Beep Type
- Good Read Beep Frequency
- Good Read Beep Length
- Good Read LED Duration
- Good Read: When to Indicate
- Green Spot Duration
- Good Read Beeper Volume
- Silent Mode (not available for QW2500)
- Illuminator Intensity

CAMERA CONTROL starting on page 105

- Aiming Pointer
- Aiming Duration Timer
- Pick Mode
- Mobile Phone Mode
- Mobile Phone Saturation Rate
- Decode Negative Image
- Image Capture

MULTIPLE LABEL READING starting on page 109

- Multiple Labels per Frame
- Multiple Labels Ordering by Code Symbology
- Multiple Labels Ordering by Code Length



SCANNING FEATURES

Scan Mode

Selects the reader's scan operating mode. See [page 280](#) in "References" for descriptions.



★ Scan Mode = Trigger Single



Scan Mode = Trigger Hold Multiple



Scan Mode = Trigger Pulse Multiple



Scan Mode = Flashing



Scan Mode = Always On



Scan Mode = Stand Mode/ Object Detection



Scan Mode = Trigger Object Sense



Scanning Active Time

This setting specifies the amount of time that the reader stays in scan ON state once the state is entered. The range for this setting is from 1 to 255 seconds in 1-second increments. See [page 280](#) in “References” for further description of this feature.



Scanning Active Time = 3 seconds



★ Scanning Active Time = 5 seconds



Scanning Active Time = 8 seconds

Flash On Time

This feature specifies the ON time for the indicator LED while in Flash Mode. The selectable range is 100 to 9,900 milliseconds (0.1 to 9.9 seconds), in 100 millisecond increments. See [page 283](#) in “References” for detailed information on setting this feature.



Select Flash ON Time Setting

To configure this feature, scan the ENTER/EXIT PROGRAMMING MODE bar code above, then the bar code at left followed by the digits from the Alphanumeric characters in [Appendix D, Keypad](#) representing your desired character(s). End by scanning the ENTER/EXIT bar code again.

Make a mistake? Scan the CANCEL bar code to abort and not save the entry string. You can then start again at the beginning.



CANCEL

★ 10 = Flash is ON for 1 Second



Flash Off Time

This feature specifies the OFF time for the indicator LED while in Flash Mode. The selectable range is 100 to 9,900 milliseconds (0.1 to 9.9 seconds), in 100 millisecond increments. See [page 284](#) in “References” for detailed information on setting this feature.



Select Flash OFF Time Setting

To configure this feature, scan the ENTER/EXIT PROGRAMMING MODE bar code above, then the bar code at left followed by the digits from the Alphanumeric characters in [Appendix D, Keypad](#) representing your desired character(s). End by scanning the ENTER/EXIT bar code again.

Make a mistake? Scan the CANCEL bar code to abort and not save the entry string. You can then start again at the beginning.



CANCEL

★06 = Flash is OFF for 600ms

Double Read Timeout

Double Read Timeout prevents a double read of the same label by setting the minimum time allowed between reads of labels of the same symbology and data. If the unit reads a label and sees the same label again within the specified timeout, the second read is ignored. Double Read Timeout does not apply to scan modes that require a trigger pull for each label read.



Double Read Timeout = 0.1 Second



Double Read Timeout = 0.2 Second



Double Read Timeout = 0.3 Second



Double Read Timeout = 0.4 Second



Double Read Timeout (continued)



Double Read Timeout = 0.5 Second



★ Double Read Timeout = 0.6 Second



Double Read Timeout = 0.7 Second



Double Read Timeout = 0.8 Second



Double Read Timeout = 0.9 Second



Double Read Timeout = 1 Second



Stand /Base Detection Behavior (QuickScan™ QD2500 only)

Specifies the behavior of the reader when stationary in a stand. There are two conditions which cause the reader to switch to Stand Mode/Object Detection:

- The reader is configured to switch to Stand Mode/Object Detection when stationary.
- The reader is placed into the base station of the base station.

Below are further options concerning Stand Operation.

Ignore Autorecognition: Disables mode switching when the reader is placed in a stand.

Switch to Stand Mode/Object Detection: Automatically switches the reader to Stand Mode/Object Detection when the reader is placed in the stand.

Switch to Always On: Automatically switches the reader to Always On mode when the reader is placed in the stand.

Switch to Flashing: Automatically switches the reader to Flash Mode when the reader is placed in the stand.



Stand/Base Detection Behavior = Ignore Autorecognition
(do not change behavior)



★ Stand/Base Detection Behavior =
Switch to Stand Mode/Object Detection



Stand/Base Detection Behavior = Switch to Always On



Stand/Base Detection Behavior = Switch to Flashing



Stand Mode/Object Detection Indication (Stand Mode Flash)

This operation is useful for indicating when the reader is in Stand Mode. If enabled, the blue indicator will blink when Stand Mode scanning is active.



★ Stand Mode/Object Detection Indication = Disable



Stand Mode/Object Detection Indication = Enable

Stand Mode/Object Detection Sensitivity

Sets the sensitivity level for stand mode/object detection wakeup. Choices are low, medium and high.



Stand/Base Detection Sensitivity = Low



★ Stand/Base Detection Sensitivity = Medium



Stand/Base Detection Sensitivity = High



Stand Mode/Object Detection Illumination Off Time

Specifies the amount of time reader illumination stays off after pulling the trigger when in Stand Mode/Object Detection. The configurable range is 01 to 32 by 01 in increments of 500ms (500ms to 16 seconds).



Set Illumination OFF Time

To configure, scan the ENTER/EXIT PROGRAMMING MODE bar code above, then the bar code at left followed by the digits from the Alphanumeric characters in [Appendix D, Keypad](#) representing your desired character(s). End by scanning the ENTER/EXIT bar code.

Make a mistake? Scan the CANCEL bar code to abort and not save the entry string. You can then start again at the beginning.



CANCEL

★04 = Illumination OFF Time 1 second

Corded Stand Mode

This parameter sets the Stand Mode operation for corded models only.



★ Corded Stand Mode = Disable



Corded Stand Mode = Generic Stand



Corded Stand Mode = Permanent Stand



Corded Stand Mode = Precise Stand



Dock Detection Beep

If enabled, when the Handheld reader is placed in a dock (base station or corded stand), it will beep.



★ Dock Detection Beep = Disable



Dock Detection Beep = Enable



LED AND BEEPER INDICATORS

Power On Alert

Disables or enables the indication (from the Beeper) that the reader is receiving power.



Power On Alert = Disable (No Audible Indication)



★ Power On Alert = Power-up Beep

Good Read Beep Type

Specifies whether the good read beep has a mono or bitonal beep sound.



★ Good Read Beep Type = Mono



Good Read Beep Type = Bitonal



Good Read Beep Frequency

Adjusts the good read beep to sound at a selectable low, medium or high frequency, selectable from the list below. (Controls the beeper's pitch/tone.)



Good Read Beep Frequency = Low



Good Read Beep Frequency = Medium



★ Good Read Beep Frequency = High



Good Read Beep Length



Good Read Beep Length = 60 msec



★ Good Read Beep Length = 80 msec



Good Read Beep Length = 100 msec



Good Read Beep Length = 120 msec



Good Read Beep Length = 140 msec



Good Read Beep Length = 160 msec



Good Read Beep Length = 180 msec



Good Read Beep Length = 200 msec



Good Read Beeper Volume

Selects the beeper volume (loudness) upon a good read beep. There are three selectable volume levels.



Good Read Beeper Volume = Beeper Off



Good Read Beeper Volume = Low



Good Read Beeper Volume = Medium



★ Good Read Beeper Volume = High



Silent Mode (not available for QW2500)

If needed, audible indications can be disabled by scanning the labels below.

Please note that some important audible notifications are not muted in silent mode and other notifications are replaced by visual indications.

All changes in audible notifications are summarized here:

- Connection / Disconnection / out of radio range beeps are replaced with blue LED
- Error beep, wireless Error/timeout beeps, chirp beeps are replaced with red top LED
- Battery beeps, Programming labels, and wireless paging beeps are not muted



Silent Mode = Enable



★ Silent Mode = Disable



Good Read LED Duration¹

This feature specifies the amount of time that the Good Read LED remains on following a good read. The good read LED on time can be set within a range of 100 milliseconds to 25,500 milliseconds (0.1 to 25.5 seconds) in 100ms increments. A setting of 00 keeps the LED on until the next trigger pull.

See [page 285](#) in “References” for detailed instructions and examples for setting this feature.



Select Good Read LED Duration Setting

Make a mistake? Scan the CANCEL bar code to abort and not save the entry string. You can then start again at the beginning.



Good Read LED Duration Setting =
Keep LED on until next trigger pull

To configure this feature, scan the ENTER/EXIT PROGRAMMING MODE bar code above, then the bar code at left followed by the digits from the Alphanumeric characters in [Appendix D, Keypad](#) representing your desired character(s). End by scanning the ENTER/EXIT bar code again.



CANCEL

★003 = Good Read LED stays on for 300 msec.

1. Available only for QuickScan™ QD2500.



Good Read: When to Indicate

This feature specifies when the reader will provide indication (beep and/or flash its green LED) upon successfully reading a bar code.



★ Indicate Good Read = After Decode



Indicate Good Read = After Transmit



Indicate Good Read =
After CTS goes inactive then active



Green Spot Duration

Specifies the duration of the good read pointer beam after a good read.



Green Spot Duration = Disable (Green Spot is Off)



★ Green Spot Duration = Short (300 msec)



Green Spot Duration = Medium (500 msec)



Green Spot Duration = Long (800 msec)



Illuminator Intensity

With the following settings the illumination intensity can be modified if needed.



Set Illumination Intensity Level = Low



Set Illumination Intensity Level = Mid-Low



Set Illumination Intensity Level = Mid



Set Illumination Intensity Level = Mid-High



★ Set Illumination Intensity Level = High



NOTE: Decreasing the Illuminator intensity level may reduce the overall reading performances.



CAMERA CONTROL

Aiming Pointer

Enables/disables the aiming pointer for all symbologies.



Aiming Pointer = Disable



★ Aiming Pointer = Enable



Aiming Pointer = Green Spot

Aiming Duration Timer

Specifies the frame of time the aiming pointer remains on after decoding a label, when in trigger single mode. The range for this setting is from 1 to 255 seconds in 1-second increments. See [page 260](#) in “References” for a description of this feature.



★ Aiming Duration Timer = Aiming Off After Decoding

To configure, scan the ENTER/EXIT PROGRAMMING MODE bar code above, then the bar code at left followed by the digits from the Alphanumeric characters in [Appendix D](#) representing your desired character(s). End by scanning the ENTER/EXIT bar code.



Aiming Duration Timer = Set Aiming Duration Timer

Make a mistake? Scan the CANCEL bar code to abort and not save the entry string. You can then start again at the beginning.



CANCEL



Pick Mode

Specifies the ability of the reader to decode labels only when they are close to the center of the aiming pattern. This allows the reader to accurately target labels when they are placed close together, such as on a pick sheet.

The Pick Mode can be enabled only in Trigger Single Scan Mode.



NOTE: This feature is not compatible with Multiple Labels Reading in a Volume.



★ Pick Mode = Disable



Pick Mode = Enable

Mobile Phone Mode

This mode is useful for scanning bar codes displayed on a mobile phone. Other options for this feature can be configured using the Datalogic Aladdin application.



Mobile Phone Mode = Disable



★ Mobile Phone Mode = Enable



Mobile Phone Mode = Enhanced



Mobile Phone Saturation Rate

This specifies the minimum number of saturated pixels (every 1000 pixels) in the image in order to activate the Mobile Phone mode.



★ Mobile Phone Saturation Rate = 00



Mobile Phone Saturation Rate = 01



Mobile Phone Saturation Rate = 02



Decode Negative Image

Enable/Disable the ability to decode a negative image for all symbologies. When this feature is enabled, you will be unable to read normally-printed labels or programming labels in this manual. Scan the "Disable" bar code below to return the reader to its default for this feature. To set decoding for only 2D codes, go to "2D Normal/Inverse Symbol Control" on [page 199](#). For additional options, see the Aladdin configuration application.



NOTE: Unlike some programming features and options, Decode Negative Image selections require that you scan only one programming bar code label. **DO NOT** scan an ENTER/EXIT bar code prior to scanning a Decode Negative Image bar code.



CAUTION: When this feature is enabled, you will be unable to read other programming labels in this manual.



★ Decode Negative Image = Disable



Decode Negative Image = Enable

Image Capture

For information and a list of options for Image Capture, use the Datalogic Aladdin configuration application, available for free download from the Datalogic Scanning website.



MULTIPLE LABEL READING

In standard (default) mode, when the reader’s aiming system is activated (by a trigger pull, motion or other method depending on the mode), it acquires and processes each image in the area in front of it (the Volume). In this case, the reader stops processing the image once it decodes a label. If several labels are present in the volume, only the first label encountered is decoded and sent.

When Multiple Reading Mode is enabled, the reader keeps on processing the image until all the labels present are decoded. The reader then sorts the data from all the bar codes (if configured to do so) before transmitting it.

Multiple Labels per Frame

Specifies the ability of the reader to decode and transmit a set of code labels in a specific volume and in a single frame of time. When in Multiple Labels per Frame the reader beeps and turns on the good read LED indication for each code read in a frame.

When Multiple Labels Mode is enabled, ISBT pairing, ABC Codabar pairing, and composites are not allowed.



★ Multiple Labels per Frame = Disable



Multiple Labels per Frame = Enable

Multiple Labels Ordering by Code Symbology

This feature allows you to specify the order multiple labels are transmitted by symbology type, when Multiple Labels per Frame is enabled.



Select Symbolologies for Multiple Labels Ordering

To configure, scan the ENTER/EXIT PROGRAMMING MODE bar code above, then the bar code at left followed by the digits from the Alphanumeric characters in [Appendix D, Keypad](#) representing your desired character(s). End by scanning the ENTER/EXIT bar code.

Make a mistake? Scan the CANCEL bar code to abort and not save the entry string. You can then start again at the beginning.



CANCEL

★ 000000000000 = Random order



Multiple Labels Ordering by Code Length

Specifies the transmission ordering by code length, when Multiple Labels per Frame is enabled.



★ Multiple Labels Ordering = Disable



Multiple Labels Ordering = Transmit Increasing Length Order



Multiple Labels Ordering = Transmit Decreasing Length Order

CONFIGURATION | 1D SYMBOLOGIES

SECTION CONTENTS

DISABLE ALL SYMBOLOGIES starting on page 112

- **COUPON CONTROL** starting on page 112
- **UPC-A** starting on page 113
- **UPC-E** starting on page 115
- **EAN-13** starting on page 118
- **EAN-8** starting on page 121
- **UPC/EAN GLOBAL SETTINGS** starting on page 123
- **GS1 DATABAR™ OMNIDIRECTIONAL** starting on page 127
- **GS1 DATABAR™ EXPANDED** starting on page 128
- **GS1 DATABAR™ LIMITED** starting on page 131
- **CODE 39** starting on page 132
- **TRIOPTIC CODE** starting on page 137
- **CODE 39 DANISH PPT** starting on page 137
- **CODE 39 PZN** starting on page 138
- **CODE 39 LA POSTE** starting on page 138
- **CODE 32 (ITALIAN PHARMACEUTICAL)** starting on page 139
- **CODE 39 CIP HR (FRENCH PHARMACEUTICAL)** starting on page 140
- **CODE 128** starting on page 141
- **GS1-128** starting on page 145
- **INTERLEAVED 2 OF 5 (I 2 OF 5)** starting on page 146
- **INTERLEAVED 2 OF 5, FEBRABAN (DESK MODELS ONLY)** starting on page 151
- **INTERLEAVED 2 OF 5 CIP HR** starting on page 151
- **MATRIX 2 OF 5** starting on page 152
- **STANDARD 2 OF 5** starting on page 155
- **COMPRESSED 2 OF 5** starting on page 158
- **DATALOGIC 2 OF 5** starting on page 161
- **INDUSTRIAL 2 OF 5** starting on page 164
- **IATA** starting on page 167
- **FOLLETT 2 OF 5** starting on page 168
- **CODABAR** starting on page 169
- **ABC CODABAR** starting on page 175
- **ISBT 128** starting on page 177
- **CODE 11** starting on page 180
- **CODE 93** starting on page 183
- **MSI** starting on page 187
- **PLESSEY** starting on page 190
- **BC412** starting on page 193



DISABLE ALL SYMBOLOGIES

Scan this label to disable all symbologies.



Disable All Symbologies

COUPON CONTROL

Coupon Control

This feature is used to control the method of processing coupon labels.

Options are:

- Allow all — allow all coupon bar codes to be decoded
- Enable only UPC/EAN — enables only UPC/EAN coupon decoding
- Enable only GS1 DataBar — enables only GS1 DataBar coupon decoding

To set this feature:

1. Scan the Enter/Exit bar code.
2. Scan either the enable or disable bar code below. You'll need to cover any unused bar codes on this and the facing page to ensure that the reader sees only the bar code you intend to scan.
3. Complete the programming sequence by scanning the Enter/Exit bar code.



Coupon Control = Allow all



★ Coupon Control = Enable only UPC-A



Coupon Control = Enable only GS1 DataBar



UPC-A

The following options apply to the UPC-A symbology.

UPC-A Enable/Disable

When disabled, the reader will not read UPC-A bar codes.



UPC-A = Disable



★ UPC-A = Enable

UPC-A Check Character Transmission

Enable this option to transmit the check character along with UPC-A bar code data.



UPC-A Check Character Transmission = Don't Send



★ UPC-A Check Character Transmission = Send



Expand UPC-A to EAN-13

Expands UPC-A data to the EAN-13 data format. Selecting this feature also changes the symbology ID to match those required for EAN-13.



★ UPC-A to EAN-13 = Don't Expand



UPC-A to EAN-13 = Expand

UPC-A Number System Character Transmission

This feature enables/disables transmission of the UPC-A number system character.



UPC-A Number System Character = Do not transmit



★ UPC-A Number System Character = Transmit



UPC-E

The following options apply to the UPC-E symbology.

UPC-E Enable/Disable

When disabled, the reader will not read UPC-E bar codes.



UPC-E = Disable



★ UPC-E = Enable

UPC-E Check Character Transmission

Enable this option to transmit the check character along with UPC-E bar code data.



UPC-E Check Character Transmission = Don't Send



★ UPC-E Check Character Transmission = Send



Expand UPC-E to EAN-13

Expands UPC-E data to the EAN-13 data format. Selecting this feature also changes the symbology ID to match those required for EAN-13.



★UPC-E to EAN-13 = Don't Expand



UPC-E to EAN-13 = Expand

Expand UPC-E to UPC-A

Expands UPC-E data to the UPC-A data format. Selecting this feature also changes the symbology ID to match those required for UPC-A.



★UPC-E to UPC-A = Don't Expand



UPC-E to UPC-A = Expand

UPC-E Number System Character Transmission

This feature enables/disables transmission of the UPC-E number system character.



UPC-E Number System Character = Do not transmit



★UPC-E Number System Character = Transmit



GTIN Formatting

This feature enables/disables the ability to convert UPC-E, UPC-A, EAN-8, and EAN-13 labels into the GTIN 14-character format.



★ GTIN Formatting = Disable



GTIN Formatting = Enable



EAN-13

The following options apply to the EAN-13 symbology.

EAN-13 Enable/Disable

When disabled, the reader will not read EAN-13 bar codes.



EAN-13 = Disable



★ EAN-13 = Enable

EAN-13 Check Character Transmission

Enable this option to transmit the check character along with EAN-13 bar code data.



EAN-13 Check Character Transmission = Don't Send



★ EAN-13 Check Character Transmission = Send



EAN-13 Flag 1 Character

Enables/disables transmission of an EAN/JAN-13 Flag1 character. The Flag 1 character is the first character of the label



EAN-13 Flag 1 Char = Don't transmit



★ EAN-13 Flag 1 Char = Transmit

EAN-13 to ISBN Conversion

This option enables/disables conversion of EAN-13/JAN-13 Bookland labels starting with 978 to ISBN labels.



★ EAN-13 ISBN Conversion = Disable



EAN-13 ISBN Conversion = Enable



EAN-13 to ISSN Conversion

Enables/disables conversion of EAN/JAN-13 Bookland labels starting with 977 to ISSN labels.



★ ISSN = Disable



ISSN = Enable



EAN-8

The following options apply to the EAN-8 symbology.

EAN-8 Enable/Disable

When disabled, the reader will not read EAN-8 bar codes.



EAN-8 = Disable



★ EAN-8 = Enable

EAN-8 Check Character Transmission

Enable this option to transmit the check character along with EAN-8 bar code data.



EAN-8 Check Character Transmission = Don't Send



★ EAN-8 Check Character Transmission = Send



Expand EAN-8 to EAN-13

Enable this option to expand EAN-8/JAN-8 labels to EAN-13/JAN-13.



★ EAN-8 to EAN-13 = Don't Expand



EAN-8 to EAN-13 = Expand



UPC/EAN GLOBAL SETTINGS

This section provides configuration settings for UPC-A, UPC-E, EAN 13 and EAN 8 symbologies, and affects all of these unless otherwise marked for each feature description.

UPC/EAN Price Weight Check

This feature enables/disables calculation and verification of price/weight check digits.

Options are

- Disabled
- Enable 4-digit price-weight check-digit calculation
- Enable 5-digit price-weight check-digit calculation
- Enable European 4-digit price-weight check-digit calculation
- Enable European 5-digit price-weight check-digit calculation



★ Price Weight Check = Disable



Price Weight Check = 4-digit price-weight check



Price Weight Check = 5-digit price-weight check



Price Weight Check = European 4-digit price-weight check



Price Weight Check = European 5-digit price-weight check



UPC/EAN Quiet Zones

This feature specifies the number of quiet zones for UPC/EAN labels. Quiet zones are blank areas at the ends of a bar code, typically 10 times the width of the narrowest bar or space in the label. The property applies to all EAN-UPC symbologies globally and to the ADD-ONS.



★ UPC/EAN Quiet Zones = Two Modules



UPC/EAN Quiet Zones = Three Modules



UPC/EAN Quiet Zones = Four Modules



UPC/EAN Quiet Zones = Five Modules



UPC/EAN Quiet Zones = Six Modules



UPC/EAN Quiet Zones = Seven Modules



UPC/EAN Quiet Zones = Eight Modules



Add-Ons

The following features apply to optional add-ons.



NOTE: Contact Customer Support for advanced programming of optional and conditional add-ons.

Optional Add-ons

The reader can be enabled to optionally read the following add-ons (supplementals):

- P2
- P5



NOTE: If a UPC/EAN base label and a an add-on are both decoded, the reader will transmit the base label and add-on. If a UPC/EAN base label is decoded without an add-on, the base label will be transmitted without an add-on.

Conditional add-on settings (if enabled) are considered by the reader before optional add-on settings.



★ Optional Add-Ons = Disable P2



Optional Add-Ons = Enable P2



★ Optional Add-Ons = Disable P5



Optional Add-Ons = Enable P5



Optional Add-On Timer

This option sets the time the reader will look for an add-on when an add-on fragment has been seen and optional add-ons are enabled.



Optional Add-on Timer = 10ms



Optional Add-on Timer = 20ms



Optional Add-on Timer = 30ms



Optional Add-on Timer = 50ms



★ Optional Add-on Timer = 70ms



Optional Add-on Timer = 100ms



Optional Add-on Timer = 160ms



GS1 DATABAR™ OMNIDIRECTIONAL

The following options apply to the GS1 DataBar Omnidirectional (formerly RSS-14) symbology.

GS1 DataBar Omnidirectional Enable/Disable

When disabled, the reader will not read GS1 DataBar Omnidirectional bar codes.



★ GS1 DataBar Omnidirectional = Disable



GS1 DataBar Omnidirectional = Enable

GS1 DataBar Omnidirectional to GS1-128 Emulation

When enabled, GS1 DataBar Omnidirectional bar codes will be translated to the GS1-128 label data format.



★ GS1 DataBar Omnidirectional to GS1-128 Emulation = Disable



GS1 DataBar Omnidirectional to GS1-128 Emulation = Enable



GS1 DATABAR™ EXPANDED

The following options apply to the GS1 DataBar Expanded (formerly RSS Expanded) symbology.

GS1 DataBar Expanded Enable/Disable

When disabled, the reader will not read GS1 DataBar Expanded bar codes.



★ GS1 DataBar Expanded = Disable



GS1 DataBar Expanded = Enable

GS1 DataBar Expanded to GS1-128 Emulation

When enabled, GS1 DataBar Expanded bar codes will be translated to the GS1-128 label data format.



★ GS1 DataBar Expanded to GS1-128 Emulation = Disable



GS1 DataBar Expanded to GS1-128 Emulation = Enable



GS1 DataBar Expanded Length Control

This feature specifies either variable length decoding or fixed length decoding for the GS1 DataBar Expanded symbology.

Variable Length: For variable-length decoding, a minimum length may be set.

Fixed Length: For fixed-length decoding, two different lengths may be set.



★ GS1 DataBar Expanded Length Control
= Variable Length



GS1 DataBar Expanded Length Control = Fixed Length

GS1 DataBar Expanded Set Length 1

This feature specifies one of the bar code lengths for "GS1 DataBar Expanded Length Control" on page 129. Length 1 is the minimum label length if in Variable Length Mode, or the first fixed length if in Fixed Length Mode. Length includes the bar code's data characters only.

The length can be set from 1 to 74 characters. See "Set Length 1" on page 288 for more detailed programming instructions.



Select GS1 DataBar Expanded Set Length 1 Setting

To configure this feature, scan the ENTER/EXIT PROGRAMMING MODE bar code above, then the bar code at left followed by the digits from the Alphanumeric characters in [Appendix D, Keypad](#) representing your desired character(s). End by scanning the ENTER/EXIT bar code again.

Make a mistake? Scan the CANCEL bar code to abort and not save the entry string. You can then start again at the beginning.



CANCEL

★ Length 1 = 01 (one character)



GS1 DataBar Expanded Set Length 2

This feature specifies one of the bar code lengths for "GS1 DataBar Expanded Length Control" on page 129. Length 2 is the maximum label length if in Variable Length Mode, or the second fixed length if in Fixed Length Mode. Length includes the bar code's data characters only.

The length can be set from 1 to 74 characters. A setting of 00 specifies to ignore this length (only one fixed length). See "Set Length 2" on page 289 for more detailed programming instructions.



Select GS1 DataBar Expanded Set Length 2 Setting

To configure this feature, scan the ENTER/EXIT PROGRAMMING MODE bar code above, then the bar code at left followed by the digits from the Alphanumeric characters in [Appendix D, Keypad](#) representing your desired character(s). End by scanning the ENTER/EXIT bar code again.

Make a mistake? Scan the CANCEL bar code to abort and not save the entry string. You can then start again at the beginning.



CANCEL

★ Length 2 = 74 (74 characters)



GS1 DATABAR™ LIMITED

The following options apply to the GS1 DataBar Limited (formerly RSS Limited) symbology.

GS1 DataBar Limited Enable/Disable

When disabled, the reader will not read GS1 DataBar Limited bar codes.



★ GS1 DataBar Limited = Disable



GS1 DataBar Limited = Enable

GS1 DataBar Limited to GS1-128 Emulation

When enabled, GS1 DataBar Limited bar codes will be translated to the GS1-128 label data format.



★ GS1 DataBar Limited to GS1-128 Emulation = Disable



GS1 DataBar Limited to GS1-128 Emulation = Enable



CODE 39

The following options apply to the Code 39 symbology.

Code 39 Enable/Disable

When disabled, the reader will not read Code 39 bar codes.



Code 39 = Disable



★ Code 39 = Enable

Code 39 Check Character Calculation

Enable this option to enable/disable calculation and verification of an optional Code 39 check character. When disabled, any check character in the label is treated as a data character.



★ Code 39 Check Character Calculation = Don't Calculate



Code 39 Check Character Calculation = Calculate Std Check



Code 39 Check Character Calculation = Calculate Mod 7 Check



Code 39 Check Character Calculation = Enable Italian Post Check



Code 39 Check Character Calculation = Enable Daimler
Chrysler Check



Code 39 Check Character Transmission

Enable this option to transmit the check character along with Code 39 bar code data.



Code 39 Check Character Transmission = Don't Send



★ Code 39 Check Character Transmission = Send

Code 39 Start/Stop Character Transmission

Enable this option to enable/disable transmission of Code 39 start and stop characters.



★ Code 39 Start/Stop Character Transmission
= Don't Transmit



Code 39 Start/Stop Character Transmission
= Transmit



Code 39 Full ASCII

In Code 39 decoding, this enables/disables the translation of Code 39 characters to Code 39 full-ASCII characters.



★ Code 39 Full ASCII = Disable



Code 39 Full ASCII = Enable

Code 39 Quiet Zones

This feature specifies the number of quiet zones for Code 39 labels. Quiet zones are blank areas at the ends of a bar code and are typically 10 times the width of the narrowest bar or space in the label.



Codabar Quiet Zones = Quiet Zone on one side



★ Codabar Quiet Zones = Quiet Zones on two sides



Codabar Quiet Zones = Auto



Codabar Quiet Zones = Virtual Quiet Zones on two sides



Codabar Quiet Zones = Small Quiet Zones on two sides



Code 39 Length Control

This feature specifies either variable length decoding or fixed length decoding for the Code 39 symbology.

Variable Length: For variable-length decoding, a minimum length may be set.

Fixed Length: For fixed-length decoding, two different lengths may be set.



★ Code 39 Length Control
= Variable Length



Code 39 Length Control = Fixed Length

Code 39 Set Length 1

This feature specifies one of the bar code lengths for "[Code 39 Length Control](#)" on [page 135](#). Length 1 is the minimum label length if in Variable Length Mode, or the first fixed length if in Fixed Length Mode. Length includes the bar code's check, data, and full-ASCII shift characters. The length does not include start/stop characters.

The length can be set from 0 to 50 characters. See "[Set Length 1](#)" on [page 288](#) for more detailed programming instructions.



Select Code 39 Set Length 1 Setting

To configure this feature, scan the ENTER/EXIT PROGRAMMING MODE bar code above, then the bar code at left followed by the digits from the Alphanumeric characters in [Appendix D, Keypad](#) representing your desired character(s). End by scanning the ENTER/EXIT bar code again.

Make a mistake? Scan the CANCEL bar code to abort and not save the entry string. You can then start again at the beginning.



CANCEL

★ Length 1 = 02 (2 characters)



Code 39 Set Length 2

This feature specifies one of the bar code lengths for "[Code 39 Length Control](#)" on page 135. Length 2 is the maximum label length if in Variable Length Mode, or the second fixed length if in Fixed Length Mode. Length includes the bar code's check, data, and full-ASCII shift characters. The length does not include start/stop characters.

The length can be set from 1 to 50 characters. A setting of 00 specifies to ignore this length (only one fixed length). See "[Set Length 2](#)" on page 289 for more detailed programming instructions.



Select Code 39 Set Length 2 Setting

To configure this feature, scan the ENTER/EXIT PROGRAMMING MODE bar code above, then the bar code at left followed by the digits from the Alphanumeric characters in [Appendix D, Keypad](#) representing your desired character(s). End by scanning the ENTER/EXIT bar code again.

Make a mistake? Scan the CANCEL bar code to abort and not save the entry string. You can then start again at the beginning.



CANCEL

★ Length 2 = 50 (50 characters)



TRIOPTIC CODE

The following options apply to the trioptic symbology.

Trioptic Code Enable/Disable

When disabled, the reader will not read Trioptic Code bar codes.



★ Trioptic Code = Disable



Trioptic Code = Enable

CODE 39 DANISH PPT

The following options apply to the Code 39 Danish PPT symbology.

Code 39 Danish PPT Enable/Disable

When disabled, the reader will not read Code 39 Danish PPT bar codes.



★ Code 39 Danish PPT = Disable



Code 39 Danish PPT = Enable



CODE 39 PZN

The following options apply to the Code 39 PZN symbology.

Code 39 PZN Enable/Disable

When disabled, the reader will not read Code 39 PZN bar codes.



★ Code 39 PZN = Disable



Code 39 PZN = Enable

CODE 39 LA POSTE

The following options apply to the Code 39 La Poste symbology.

Code 39 La Poste Enable/Disable

When disabled, the reader will not read Code 39 La Poste bar codes.



★ Code 39 La Poste = Disable



Code 39 La Poste = Enable



CODE 32 (ITALIAN PHARMACEUTICAL)

The following options apply to the Code 32 symbology.

Code 32 Enable/Disable

When disabled, the reader will not read Code 32 bar codes.



★ Code 32 = Disable



Code 32 = Enable

Code 32 Feature Setting Exceptions



NOTE: The following features are set for Code 32 by using these Code 39 settings:

"Code 39 Quiet Zones" on page 134

"Code 39 Length Control" on page 135

Code 32 Check Character Transmission

Enable this option to transmit the check character along with Code 32 bar code data.



★ Code 32 Check Character Transmission = Don't
Send



Code 32 Check Character Transmission = Send



Code 32 Start/Stop Character Transmission

Enable this option to enable/disable transmission of Code 32 start and stop characters.



★ Code 32 Start/Stop Character Transmission
= Don't Transmit



Code 32 Start/Stop Character Transmission
= Transmit

CODE 39 CIP HR (FRENCH PHARMACEUTICAL)

The following options apply to the Code 39 CIP HR symbology.

Code 39 CIP HR Enable/Disable

Enables/Disables ability of the reader to decode Code 39 CIP HR labels.



★ Code 39 CIP HR = Disable



Code 39 CIP HR = Enable



CODE 128

The following options apply to the Code 128 symbology.

Code 128 Enable/Disable

Enables/Disables ability of the reader to decode Code 128 labels.



Code 128 = Disable



★ Code 128 = Enable

Expand Code 128 to Code 39

This feature enables/disables expansion of Code 128 labels to Code 39 labels. When enabled, the label identifier for a Code 128 label shall be set to Code 39 and all Code 39 formatting control shall be applied to the label.



★ Code 128 to Code 39 = Don't Expand



Code 128 to Code 39 = Expand



Code 128 Check Character Transmission

Enable this option to transmit the check character along with Code 128 bar code data.



★ Code 128 Check Character Transmission =
Don't Send



Code 128 Check Character Transmission = Send

Code 128 Function Character Transmission

Enables/disables transmission of Code128 function characters 1, 2, 3, and 4.



★ Code 128 Function Character Transmission =
Don't Send



Code 128 Function Character Transmission = Send



Code 128 Quiet Zones

This feature specifies the number of quiet zones for Code 128 labels. Quiet zones are blank areas at the ends of a bar code and are typically 10 times the width of the narrowest bar or space in the label.



Code 128 Quiet Zones = No Quiet Zones



Code 128 Quiet Zones = Quiet Zone on one side



Code 128 Quiet Zones = Quiet Zones on two sides



★ Code 128 Quiet Zones = Auto



Code 128 Quiet Zones = Virtual Quiet Zones on two sides

Code 128 Length Control

This feature specifies either variable length decoding or fixed length decoding for the Code 128 symbology.

Variable Length: For variable-length decoding, a minimum length may be set.

Fixed Length: For fixed-length decoding, two different lengths may be set.



★ Code 128 Length Control = Variable Length



Code 128 Length Control = Fixed Length



Code 128 Set Length 1

This feature specifies one of the bar code lengths for "[Code 128 Length Control](#)" on page 143. Length 1 is the minimum label length if in Variable Length Mode, or the first fixed length if in Fixed Length Mode. Length includes the bar code's data characters only.

The length can be set from 1 to 80 characters. See "[Set Length 1](#)" on page 288 for more detailed programming instructions.



Select Code 128 Set Length 1 Setting

To configure this feature, scan the ENTER/EXIT PROGRAMMING MODE bar code above, then the bar code at left followed by the digits from the Alphanumeric characters in [Appendix D, Keypad](#) representing your desired character(s). End by scanning the ENTER/EXIT bar code again.

Make a mistake? Scan the CANCEL bar code to abort and not save the entry string. You can then start again at the beginning.



CANCEL

★ Length 1 = 01 (one character)

Code 128 Set Length 2

This feature specifies one of the bar code lengths for "[Code 128 Length Control](#)" on page 143. Length 2 is the maximum label length if in Variable Length Mode, or the second fixed length if in Fixed Length Mode. Length includes the bar code's data characters only.

The length can be set from 1 to 80 characters. A setting of 00 specifies to ignore this length (only one fixed length). See "[Set Length 2](#)" on page 289 for more detailed programming instructions.



Select Code 128 Set Length 2 Setting

To configure this feature, scan the ENTER/EXIT PROGRAMMING MODE bar code above, then the bar code at left followed by the digits from the Alphanumeric characters in [Appendix D, Keypad](#) representing your desired character(s). End by scanning the ENTER/EXIT bar code again.

Make a mistake? Scan the CANCEL bar code to abort and not save the entry string. You can then start again at the beginning.



CANCEL

★ Length 2 = 80 (80 characters)



GS1-128

The following options apply to the GS1-128 symbology. (Also known as USS-128, GTIN-128, UCC-128.)

GS1-128 Enable

This option enables/disables the ability of the reader to translate GS1-128 labels to the GS1-128 data format. Options are:

- Transmit GS1-128 labels in Code 128 data format.
- Transmit GS1-128 labels in GS1-128 data format.
- Do not transmit GS1-128 labels.



GS1-128 = Transmit in Code 128 data format



★ GS1-128 = Transmit in GS1-128 data format



GS1-128 = Do not transmit GS1-128 labels



INTERLEAVED 2 OF 5 (I 2 OF 5)

The following options apply to the I 2 of 5 symbology.



CAUTION: When reading this symbology, the settings for I 2 of 5 Length Control AND I 2 of 5 Check Character Calculation MUST be enabled to increase decoding safety.

I 2 of 5 Enable/Disable

When disabled, the reader will not read I 2 of 5 bar codes.



★ I 2 of 5 = Disable



I 2 of 5 = Enable



I 2 of 5 Check Character Calculation

This option enables/disables calculation and verification of an optional I 2 of 5 check character.



★ I 2 of 5 Check Character Calculation = Disable



I 2 of 5 Check Character Calculation
= Calculate Std Check (Modulo 10 no AR)



I 2 of 5 Check Character Calculation
= Calculate German Parcel Check



I 2 of 5 Check Character Calculation
= Calculate DHL Check



I 2 of 5 Check Character Calculation
= Calculate Daimler Chrysler Check



I 2 of 5 Check Character Calculation (continued)



I 2 of 5 Check Character Calculation
= Calculate Bosch Check



I 2 of 5 Check Character Calculation
= Calculate Italian Post Check

I 2 of 5 Check Character Transmission

Enable this option to transmit the check character along with I 2 of 5 bar code data.



NOTE: This feature is valid only when I 2 of 5 Check Character Calculation is enabled.



I 2 of 5 Check Character Transmission = Don't Send



★ I 2 of 5 Check Character Transmission = Send



I 2 of 5 Length Control

This feature specifies either variable length decoding or fixed length decoding for the I 2 of 5 symbology.

Variable Length: For variable-length decoding, a minimum length may be set.

Fixed Length: For fixed-length decoding, two different lengths may be set.



★ I 2 of 5 Length Control = Variable Length



I 2 of 5 Length Control = Fixed Length

I 2 of 5 Set Length 1

This feature specifies one of the bar code lengths for "I 2 of 5 Length Control" on page 149. Length 1 is the minimum label length if in Variable Length Mode, or the first fixed length if in Fixed Length Mode. The length includes the bar code's check and data characters. The length can be set from 2 to 50 characters in increments of two. See "Set Length 1" on page 288 for more detailed programming instructions.



Select I 2 of 5 Set Length 1 Setting

To configure this feature, scan the ENTER/EXIT PROGRAMMING MODE bar code above, then the bar code at left followed by the digits from the Alphanumeric characters in [Appendix D, Keypad](#) representing your desired character(s). End by scanning the ENTER/EXIT bar code again.

Make a mistake? Scan the CANCEL bar code to abort and not save the entry string. You can then start again at the beginning.



CANCEL

★ Length 1 = 06 (6 characters)



I 2 of 5 Set Length 2

This feature specifies one of the bar code lengths for "I 2 of 5 Length Control" on page 149. Length 2 is the maximum label length if in Variable Length Mode, or the second fixed length if in Fixed Length Mode. The length includes the bar code's check and data characters. The length can be set from 2 to 50 characters in increments of two. A setting of 00 specifies to ignore this length (only one fixed length). See "Set Length 2" on page 289 for more detailed programming instructions.



Select I 2 of 5 Set Length 2 Setting

To configure this feature, scan the ENTER/EXIT PROGRAMMING MODE bar code above, then the bar code at left followed by the digits from the Alphanumeric characters in [Appendix D, Keypad](#) representing your desired character(s). End by scanning the ENTER/EXIT bar code again.

Make a mistake? Scan the CANCEL bar code to abort and not save the entry string. You can then start again at the beginning.



CANCEL

★ Length 2 = 50 (50 characters)



INTERLEAVED 2 OF 5, FEBRABAN (DESK MODELS ONLY)

Interleaved 2 of 5, Febraban format Enable / Disable



NOTE: Interleaved 2 of 5 shall be enabled before enabling Febraban variant.

Enables/Disables ability of reader to decode Interleaved 2 of 5, Febraban format.



★ 2 of 5, Febraban format = Disable



2 of 5, Febraban format = Enable

INTERLEAVED 2 OF 5 CIP HR

The following options apply to the Interleaved 2 of 5 CIP HR symbology.

Interleaved 2 of 5 CIP HR Enable/Disable

Enables/Disables ability of the reader to decode Interleaved 2 of 5 CIP HR labels.



★ Interleaved 2 of 5 CIP HR = Disable



Interleaved 2 of 5 CIP HR = Enable



MATRIX 2 OF 5

The following options apply to the Matrix 2 of 5 symbology.

Matrix 2 of 5 Enable/Disable

When disabled, the reader will not read Matrix 2 of 5 bar codes.



★ Matrix 2 of 5 = Disable



Matrix 2 of 5 = Enable

Matrix 2 of 5 Check Character Calculation

This option enables/disables calculation and verification of an optional Matrix 2 of 5 check character.



★ Matrix 2 of 5 Check Character Calculation
= Disable



Matrix 2 of 5 Check Character Calculation = Enable



Matrix 2 of 5 Check Character Transmission

This feature enables/disables transmission of an optional Matrix 2 of 5 check character.



Matrix 2 of 5 Check Character Transmission
= Don't Send



★ Matrix 2 of 5 Check Character Transmission
= Send

Matrix 2 of 5 Length Control

This feature specifies either variable length decoding or fixed length decoding for the Matrix 2 of 5 symbology.

Variable Length: For variable-length decoding, a minimum length may be set.

Fixed Length: For fixed-length decoding, two different lengths may be set.



★ Matrix 2 of 5 Length Control = Variable Length



Matrix 2 of 5 Length Control = Fixed Length



Matrix 2 of 5 Set Length 1

This feature specifies one of the bar code lengths for "Standard 2 of 5 Length Control" on [page 156](#). Length 1 is the minimum label length if in Variable Length Mode, or the first fixed length if in Fixed Length Mode. The length includes the bar code's check and data characters.

The length can be set from 1 to 50 characters. See "Set Length 1" on [page 288](#) for more detailed programming instructions.



Select Matrix 2 of 5 Length 1 Setting

To configure this feature, scan the ENTER/EXIT PROGRAMMING MODE bar code above, then the bar code at left followed by the digits from the Alphanumeric characters in [Appendix D, Keypad](#) representing your desired character(s). End by scanning the ENTER/EXIT bar code again.

Make a mistake? Scan the CANCEL bar code to abort and not save the entry string. You can then start again at the beginning.



CANCEL

★ Length 1 = 08 (8 characters)

Matrix 2 of 5 Set Length 2

This feature specifies one of the bar code lengths for "Standard 2 of 5 Length Control" on [page 156](#). Length 2 is the maximum label length if in Variable Length Mode, or the second fixed length if in Fixed Length Mode. The length includes the bar code's check and data characters.

The length can be set from 1 to 50 characters. A setting of 00 specifies to ignore this length (only one fixed length). See "Set Length 2" on [page 289](#) for more detailed programming instructions.



Select Matrix 2 of 5 Set Length 2 Setting

To configure this feature, scan the ENTER/EXIT PROGRAMMING MODE bar code above, then the bar code at left followed by the digits from the Alphanumeric characters in [Appendix D, Keypad](#) representing your desired character(s). End by scanning the ENTER/EXIT bar code again.

Make a mistake? Scan the CANCEL bar code to abort and not save the entry string. You can then start again at the beginning.



CANCEL

★ Length 2 = 50 (50 characters)



STANDARD 2 OF 5

The following options apply to the Standard 2 of 5 symbology.

Standard 2 of 5 Enable/Disable

When disabled, the reader will not read Standard 2 of 5 bar codes.



★ Standard 2 of 5 = Disable



Standard 2 of 5 = Enable

Standard 2 of 5 Check Character Calculation

This option enables/disables calculation and verification of an optional Standard 2 of 5 check character.



★ Standard 2 of 5 Check Character Calculation
= Disable



Standard 2 of 5 Check Character Calculation = Enable



Standard 2 of 5 Check Character Transmission

This feature enables/disables transmission of an optional Standard 2 of 5 check character.



Standard 2 of 5 Check Character Transmission
= Don't Send



★ Standard 2 of 5 Check Character Transmission
= Send

Standard 2 of 5 Length Control

This feature specifies either variable length decoding or fixed length decoding for the Standard 2 of 5 symbology.

Variable Length: For variable-length decoding, a minimum length may be set.

Fixed Length: For fixed-length decoding, two different lengths may be set.



★ Standard 2 of 5 Length Control = Variable Length



Standard 2 of 5 Length Control = Fixed Length



Standard 2 of 5 Set Length 1

This feature specifies one of the bar code lengths for "[Standard 2 of 5 Length Control](#)" on [page 156](#). Length 1 is the minimum label length if in Variable Length Mode, or the first fixed length if in Fixed Length Mode. The length includes the bar code's check and data characters.

The length can be set from 1 to 50 characters. See "[Set Length 1](#)" on [page 288](#) for more detailed programming instructions.



Select Standard 2 of 5 Length 1 Setting

To configure this feature, scan the ENTER/EXIT PROGRAMMING MODE bar code above, then the bar code at left followed by the digits from the Alphanumeric characters in [Appendix D, Keypad](#) representing your desired character(s). End by scanning the ENTER/EXIT bar code again.

Make a mistake? Scan the CANCEL bar code to abort and not save the entry string. You can then start again at the beginning.



CANCEL

★ Length 1 = 08 (8 characters)

Standard 2 of 5 Set Length 2

This feature specifies one of the bar code lengths for "[Standard 2 of 5 Length Control](#)" on [page 156](#). Length 2 is the maximum label length if in Variable Length Mode, or the second fixed length if in Fixed Length Mode. The length includes the bar code's check and data characters.

The length can be set from 1 to 50 characters. A setting of 00 specifies to ignore this length (only one fixed length). See "[Set Length 2](#)" on [page 289](#) for more detailed programming instructions.



Select Standard 2 of 5 Set Length 2 Setting

To configure this feature, scan the ENTER/EXIT PROGRAMMING MODE bar code above, then the bar code at left followed by the digits from the Alphanumeric characters in [Appendix D, Keypad](#) representing your desired character(s). End by scanning the ENTER/EXIT bar code again.

Make a mistake? Scan the CANCEL bar code to abort and not save the entry string. You can then start again at the beginning.



CANCEL

★ Length 2 = 50 (50 characters)



COMPRESSED 2 OF 5

The following options apply to the Compressed 2 of 5 symbology.

Compressed 2 of 5 Enable/Disable

When disabled, the reader will not read Compressed 2 of 5 bar codes.



★ Compressed 2 of 5 = Disable



Compressed 2 of 5 = Enable

Compressed 2 of 5 Check Character Calculation

This option enables/disables calculation and verification of an optional Compressed 2 of 5 check character.



★ Compressed 2 of 5 Check Character Calculation = Disable



Compressed 2 of 5 Check Character Calculation = Enable



Compressed 2 of 5 Check Character Transmission

This feature enables/disables transmission of an optional Compressed 2 of 5 check character.



Compressed 2 of 5 Check Character Transmission
= Don't Send



★ Compressed 2 of 5 Check Character Transmission
= Send

Compressed 2 of 5 Length Control

This feature specifies either variable length decoding or fixed length decoding for the Compressed 2 of 5 symbology.

Variable Length: For variable-length decoding, a minimum length may be set.

Fixed Length: For fixed-length decoding, two different lengths may be set.



★ Compressed 2 of 5 Length Control = Variable
Length



Compressed 2 of 5 Length Control = Fixed Length



Compressed 2 of 5 Set Length 1

This feature specifies one of the bar code lengths for "[Compressed 2 of 5 Length Control](#)" on page 159. Length 1 is the minimum label length if in Variable Length Mode, or the first fixed length if in Fixed Length Mode. The length includes the bar code's check and data characters.

The length can be set from 1 to 50 characters. See "[Set Length 1](#)" on page 288 for more detailed programming instructions.



Select Compressed 2 of 5 Length 1 Setting

To configure this feature, scan the ENTER/EXIT PROGRAMMING MODE bar code above, then the bar code at left followed by the digits from the Alphanumeric characters in [Appendix D, Keypad](#) representing your desired character(s). End by scanning the ENTER/EXIT bar code again.

Make a mistake? Scan the CANCEL bar code to abort and not save the entry string. You can then start again at the beginning.



CANCEL

★ Length 1 = 01 (one character)

Compressed 2 of 5 Set Length 2

This feature specifies one of the bar code lengths for "[Compressed 2 of 5 Length Control](#)" on page 159. Length 2 is the maximum label length if in Variable Length Mode, or the second fixed length if in Fixed Length Mode. The length includes the bar code's check and data characters.

The length can be set from 1 to 50 characters. A setting of 00 specifies to ignore this length (only one fixed length). See "[Set Length 2](#)" on page 289 for more detailed programming instructions.



Select Compressed 2 of 5 Set Length 2 Setting

To configure this feature, scan the ENTER/EXIT PROGRAMMING MODE bar code above, then the bar code at left followed by the digits from the Alphanumeric characters in [Appendix D, Keypad](#) representing your desired character(s). End by scanning the ENTER/EXIT bar code again.

Make a mistake? Scan the CANCEL bar code to abort and not save the entry string. You can then start again at the beginning.



CANCEL

★ Length 2 = 50 (50 characters)



DATALOGIC 2 OF 5

The following options apply to the Datalogic 2 of 5 symbology.

Datalogic 2 of 5 Enable/Disable

When disabled, the reader will not read Datalogic 2 of 5 bar codes.



★ Datalogic 2 of 5 = Disable



Datalogic 2 of 5 = Enable

Datalogic 2 of 5 Check Character Calculation

This option enables/disables calculation and verification of an optional Datalogic 2 of 5 check character.



★ Datalogic 2 of 5 Check Character Calculation = Disable



Datalogic 2 of 5 Check Character Calculation = Enable



Datalogic 2 of 5 Check Character Transmission

Enable this option to transmit the check character along with Datalogic 2 of 5 bar code data.



Datalogic 2 of 5 Check Character Transmission
= Don't Send



★ Datalogic 2 of 5 Check Character Transmission
= Send

Datalogic 2 of 5 Length Control

This feature specifies either variable length decoding or fixed length decoding for the Datalogic 2 of 5 symbology.

Variable Length: For variable-length decoding, a minimum length may be set.

Fixed Length: For fixed-length decoding, two different lengths may be set.



★ Datalogic 2 of 5 Length Control = Variable Length



Datalogic 2 of 5 Length Control = Fixed Length



Datalogic 2 of 5 Set Length 1

This feature specifies one of the bar code lengths for "Datalogic 2 of 5 Length Control" on page 162. Length 1 is the minimum label length if in Variable Length Mode, or the first fixed length if in Fixed Length Mode. The length includes the bar code's check and data characters. The length can be set from 2 to 50 characters in increments of two. See "Set Length 1" on page 288 for more detailed programming instructions.



Select Datalogic 2 of 5 Length 1 Setting

To configure this feature, scan the ENTER/EXIT PROGRAMMING MODE bar code above, then the bar code at left followed by the digits from the Alphanumeric characters in Appendix D, Keypad representing your desired character(s). End by scanning the ENTER/EXIT bar code again.

Make a mistake? Scan the CANCEL bar code to abort and not save the entry string. You can then start again at the beginning.



CANCEL

★ Length 1 = 06 (6 characters)

Datalogic 2 of 5 Set Length 2

This feature specifies one of the bar code lengths for "Datalogic 2 of 5 Length Control" on page 162. Length 2 is the maximum label length if in Variable Length Mode, or the second fixed length if in Fixed Length Mode. The length includes the bar code's check and data characters. The length can be set from 2 to 50 characters. A setting of 00 specifies to ignore this length (only one fixed length). See "Set Length 2" on page 289 for more detailed programming instructions.



Select Datalogic 2 of 5 Set Length 2 Setting

To configure this feature, scan the ENTER/EXIT PROGRAMMING MODE bar code above, then the bar code at left followed by the digits from the Alphanumeric characters in Appendix D, Keypad representing your desired character(s). End by scanning the ENTER/EXIT bar code again.

Make a mistake? Scan the CANCEL bar code to abort and not save the entry string. You can then start again at the beginning.



CANCEL

★ Length 2 = 50 (50 characters)



INDUSTRIAL 2 OF 5

The following options apply to the Industrial 2 of 5 symbology.

Industrial 2 of 5 Enable/Disable

When disabled, the reader will not read Industrial 2 of 5 bar codes.



★ Industrial 2 of 5 = Disable



Industrial 2 of 5 = Enable

Industrial 2 of 5 Check Character Calculation

Enables/Disables calculation and verification of an optional Industrial 2 of 5 check character.



★ Industrial 2 of 5 Check Character Calculation
= Disable



Industrial 2 of 5 Check Character Calculation = Enable



Industrial 2 of 5 Check Character Transmission

Enables/disables transmission of an Industrial 2 of 5 check character.



Industrial 2 of 5 Check Character Transmission
= Don't Send



★ Industrial 2 of 5 Check Character Transmission
= Send

Industrial 2 of 5 Length Control

This feature specifies either variable length decoding or fixed length decoding for the Industrial 2 of 5 symbology.

Variable Length: For variable-length decoding, a minimum length may be set.

Fixed Length: For fixed-length decoding, two different lengths may be set.



★ Industrial 2 of 5 Length Control = Variable Length



Industrial 2 of 5 Length Control = Fixed Length



Industrial 2 of 5 Set Length 1

This feature specifies one of the bar code lengths for "Industrial 2 of 5 Length Control" on page 165. Length 1 is the minimum label length if in Variable Length Mode, or the first fixed length if in Fixed Length Mode. The length includes the bar code's check and data characters.

The length can be set from 1 to 50 characters. See "Set Length 1" on page 288 for more detailed programming instructions.



Select Industrial 2 of 5 Length 1 Setting

To configure this feature, scan the ENTER/EXIT PROGRAMMING MODE bar code above, then the bar code at left followed by the digits from the Alphanumeric characters in Appendix D, Keypad representing your desired character(s). End by scanning the ENTER/EXIT bar code again.

Make a mistake? Scan the CANCEL bar code to abort and not save the entry string. You can then start again at the beginning.



CANCEL

★ Length 1 = 06 (6 characters)

Industrial 2 of 5 Set Length 2

This feature specifies one of the bar code lengths for "Industrial 2 of 5 Length Control" on page 165. Length 2 is the maximum label length if in Variable Length Mode, or the second fixed length if in Fixed Length Mode. The length includes the bar code's check and data characters.

The length can be set from 1 to 50 characters. A setting of 00 specifies to ignore this length (only one fixed length). See "Set Length 2" on page 289 for more detailed programming instructions.



Select Industrial 2 of 5 Set Length 2 Setting

To configure this feature, scan the ENTER/EXIT PROGRAMMING MODE bar code above, then the bar code at left followed by the digits from the Alphanumeric characters in Appendix D, Keypad representing your desired character(s). End by scanning the ENTER/EXIT bar code again.

Make a mistake? Scan the CANCEL bar code to abort and not save the entry string. You can then start again at the beginning.



CANCEL

★ Length 2 = 50 (50 characters)



IATA

The following options apply to the IATA symbology.

IATA Enable/Disable

Enables/Disables the ability of the reader to decode IATA labels.



★ IATA = Disable



IATA = Enable

IATA Check Character Transmission

Enables/Disables calculation and verification of an optional IATA check character.



IATA Check Character Transmission
= Don't Send



★ IATA Check Character Transmission
= Send



FOLLETT 2 OF 5

The following options apply to the Follett 2 of 5 symbology.

Follett 2 of 5 Enable/Disable

Enables/Disables ability of reader to decode Follett 2 of 5 labels.



★ Follett 2 of 5 = Disable



Follett 2 of 5 = Enable



CODABAR

The following options apply to the Codabar symbology.

Codabar Enable/Disable

When disabled, the reader will not read Codabar bar codes.



★ Codabar = Disable



Codabar = Enable

Codabar Check Character Calculation

This option enables/disables calculation and verification of an optional Codabar check character. When disabled, any check characters in the label are treated as data characters.



★ Codabar Check Character Calculation = Disable



Codabar Check Character Calculation
= Calculate AIM Std Check



Codabar Check Character Calculation
= Calculate Modulo 10 Check



Codabar Check Character Calculation
= Calculate NW-7 Check



Codabar Check Character Transmission

Enable this option to transmit the check character along with Codabar bar code data.



NOTE: This feature is valid only when Codabar Check Character Calculation is enabled.



Codabar Check Character Transmission
= Don't Send



★ Codabar Check Character Transmission
= Send

Codabar Start/Stop Character Transmission

This option enables/disables transmission of Codabar start and stop characters.



Codabar Start/Stop Character Transmission
= Don't Transmit



★ Codabar Start/Stop Character Transmission
= Transmit



Codabar Start/Stop Character Set

This option specifies the format of transmitted Codabar start/stop characters.



Codabar Check Character Set = ABCD/TN*E



Codabar Check Character Set = ABCD/ABCD



Codabar Check Character Set = abcd/tn*e



★ Codabar Check Character Set = abcd/abcd

Codabar Start/Stop Character Match

When enabled, this option requires that start and stop characters match



★ Codabar Start/Stop Character Match
= Don't Require Match



Codabar Start/Stop Character Match = Require Match



Codabar Quiet Zones

This feature specifies the number of quiet zones for Codabar labels. Quiet zones are blank areas at the ends of a bar code and are typically 10 times the width of the narrowest bar or space in the label.



Codabar Quiet Zones = Quiet Zone on one side



★ Codabar Quiet Zones = Quiet Zones on two sides



Codabar Quiet Zones = Auto



Codabar Quiet Zones = Virtual Quiet Zones on two sides



Codabar Quiet Zones = Small Quiet Zones on two sides



Codabar Length Control

This feature specifies either variable length decoding or fixed length decoding for the Codabar symbology.

Variable Length: For variable-length decoding, a minimum length may be set.

Fixed Length: For fixed-length decoding, two different lengths may be set.



★ Codabar Length Control = Variable Length



Codabar Length Control = Fixed Length

Codabar Set Length 1

This feature specifies one of the bar code lengths for "Codabar Length Control" on page 173. Length 1 is the minimum label length if in Variable Length Mode, or the first fixed length if in Fixed Length Mode. Length includes the bar code's start, stop, check and data characters. The length must include at least one data character.

The length can be set from 3 to 50 characters. See "Set Length 1" on page 288 for more detailed programming instructions.



Select Codabar Length 1 Setting

To configure this feature, scan the ENTER/EXIT PROGRAMMING MODE bar code above, then the bar code at left followed by the digits from the Alphanumeric characters in Appendix D, Keypad representing your desired character(s). End by scanning the ENTER/EXIT bar code again.

Make a mistake? Scan the CANCEL bar code to abort and not save the entry string. You can then start again at the beginning.



CANCEL

★ Length 1 = 03 (3 characters)



Codabar Set Length 2

This feature specifies one of the bar code lengths for "Codabar Length Control" on page 173. Length 2 is the maximum label length if in Variable Length Mode, or the second fixed length if in Fixed Length Mode. The length includes the bar code's start, stop, check and data characters. The length must include at least one data character.

The length can be set from 3 to 50 characters. A setting of 00 specifies to ignore this length (only one fixed length). See "Set Length 2" on page 289 for more detailed programming instructions.



Select Codabar Length 2 Setting

To configure this feature, scan the ENTER/EXIT PROGRAMMING MODE bar code above, then the bar code at left followed by the digits from the Alphanumeric characters in [Appendix D, Keypad](#) representing your desired character(s). End by scanning the ENTER/EXIT bar code again.

Make a mistake? Scan the CANCEL bar code to abort and not save the entry string. You can then start again at the beginning.



CANCEL

★ Length 2 = 50 (50 characters)



ABC CODABAR

The following options apply to the ABC Codabar symbology.

ABC Codabar Enable/Disable

Enables/Disables ability of reader to decode ABC Codabar labels.



★ ABC Codabar = Disable



ABC Codabar = Enable

ABC Codabar Concatenation Mode

Specifies the concatenation mode between Static and Dynamic.



★ ABC Codabar Concatenation Mode = Static



ABC Codabar Concatenation Mode = Dynamic



ABC Codabar Dynamic Concatenation Timeout

This parameter specifies the timeout in 10-millisecond ticks used by the ABC Codabar Dynamic Concatenation Mode. The timeout can be set within a range of 05 to 255 in 10ms increments. A setting of zero specifies no delay.



Select ABC Codabar Dynamic Concatenation Timeout Setting

To configure this feature, scan the ENTER/EXIT PROGRAMMING MODE bar code above, then the bar code at left followed by the digits from the Alphanumeric characters in [Appendix D, Keypad](#) representing your desired character(s). End by scanning the ENTER/EXIT bar code again.

Make a mistake? Scan the CANCEL bar code to abort and not save the entry string. You can then start again at the beginning.



CANCEL

★ Timeout = 20 (200 msec)

ABC Codabar Force Concatenation

When ABC Codabar Concatenation is enabled and Force Concatenation is disabled, both Codabar stand alone labels and ABC Codabar concatenated labels are transmitted. When ABC Codabar Concatenation is enabled and Force Concatenation is enabled only ABC Codabar concatenated labels are transmitted while Codabar stand alone labels are not transmitted.

Force Concatenation has no effect if the ABC Codabar Concatenation is disabled. The Force Concatenation mode has effect both in Static and Dynamic Concatenation Modes.



★ ABC Codabar Force Concatenation = Disable



ABC Codabar Force Concatenation = Enable



ISBT 128

The following options apply to the ISBT 128 symbology.

ISBT 128 Concatenation

Enables/disables ISBT 128 concatenation of 2 labels.



★ ISBT 128 Concatenation = Disable



ISBT 128 Concatenation = Enable

ISBT 128 Concatenation Mode

Specifies the concatenation mode between Static and Dynamic.



★ ISBT 128 Concatenation Mode = Static



ISBT 128 Concatenation Mode = Dynamic



ISBT 128 Dynamic Concatenation Timeout

Specifies the timeout used by the ISBT 128 Dynamic Concatenation Mode.



ISBT 128 Dynamic Concatenation Timeout = 50 msec



ISBT 128 Dynamic Concatenation Timeout = 100 msec



★ ISBT 128 Dynamic Concatenation Timeout = 200 msec



ISBT 128 Dynamic Concatenation Timeout = 500 msec



ISBT 128 Dynamic Concatenation Timeout = 750 msec



ISBT 128 Dynamic Concatenation Timeout = 1 second



ISBT 128 Force Concatenation

When enabled, this feature forces all ISBT 128 labels to be concatenated.



NOTE: This option is only valid when "ISBT 128 Concatenation" on page 177 is enabled.



★ ISBT 128 Force Concatenation = Disable



ISBT 128 Force Concatenation = Enable

ISBT 128 Advanced Concatenation Options



NOTE: Use the Datalogic Aladdin configuration application or Contact Customer Support to set up pairs of label types for concatenation.



CODE 11

The following options apply to the Code 11 symbology.

Code 11 Enable/Disable

When disabled, the reader will not read Code 11 bar codes.



★ Code 11 = Disable



Code 11 = Enable

Code 11 Check Character Calculation

This option enables/disables calculation and verification of optional Code 11 check character.



Code 11 Check Character Calculation = Disable



Code 11 Check Character Calculation = Calculate Check C



Code 11 Check Character Calculation
= Calculate Check K



★ Code 11 Check Character Calculation
= Calculate Check C and K



Code 11 Check Character Transmission

This feature enables/disables transmission of an optional Code 11 check character.



Code 11 Check Character Transmission = Don't Send



★ Code 11 Check Character Transmission = Send

Code 11 Length Control

This feature specifies either variable length decoding or fixed length decoding for the Code 11 symbology.

Variable Length: For variable-length decoding, a minimum length may be set.

Fixed Length: For fixed-length decoding, two different lengths may be set.



★ Code 11 Length Control = Variable Length



Code 11 Length Control = Fixed Length



Code 11 Set Length 1

This feature specifies one of the bar code lengths for "Code 11 Length Control" on page 181. Length 1 is the minimum label length if in Variable Length Mode, or the first fixed length if in Fixed Length Mode. Length includes the bar code's check and data characters.

The length can be set from 2 to 50 characters. See "Set Length 1" on page 288 for more detailed programming instructions.



Select Code 11 Length 1 Setting

To configure this feature, scan the ENTER/EXIT PROGRAMMING MODE bar code above, then the bar code at left followed by the digits from the Alphanumeric characters in [Appendix D, Keypad](#) representing your desired character(s). End by scanning the ENTER/EXIT bar code again.

Make a mistake? Scan the CANCEL bar code to abort and not save the entry string. You can then start again at the beginning.



CANCEL

★ Length 1 = 04 (4 characters)

Code 11 Set Length 2

This feature specifies one of the bar code lengths for "Code 11 Length Control" on page 181. Length 2 is the maximum label length if in Variable Length Mode, or the second fixed length if in Fixed Length Mode. Length includes the bar code's check and data characters.

The length can be set from 2 to 50 characters. A setting of 00 specifies to ignore this length (only one fixed length). See "Set Length 2" on page 289 for more detailed programming instructions.



Select Code 11 Length 2 Setting

To configure this feature, scan the ENTER/EXIT PROGRAMMING MODE bar code above, then the bar code at left followed by the digits from the Alphanumeric characters in [Appendix D, Keypad](#) representing your desired character(s). End by scanning the ENTER/EXIT bar code again.

Make a mistake? Scan the CANCEL bar code to abort and not save the entry string. You can then start again at the beginning.



CANCEL

★ Length 2 = 50 (50 characters)



CODE 93

The following options apply to the Code 93 symbology.

Code 93 Enable/Disable

Enables/Disables ability of reader to decode Code 93 labels.



★ Code 93 = Disable



Code 93 = Enable

Code 93 Check Character Calculation

This option enables/disables calculation and verification of optional Code 93 check character.



Code 93 Check Character Calculation = Disable



Code 93 Check Character Calculation = Calculate Check C



Code 93 Check Character Calculation
= Calculate Check K



★ Code 93 Check Character Calculation
= Calculate Check C and K



Code 93 Check Character Transmission

This feature enables/disables transmission of an optional Code 93 check character.



★ Code 93 Check Character Transmission = Don't Send



Code 93 Check Character Transmission = Send

Code 93 Length Control

This feature specifies either variable length decoding or fixed length decoding for the Code 93 symbology.

Variable Length: For variable-length decoding, a minimum length may be set.

Fixed Length: For fixed-length decoding, two different lengths may be set.



★ Code 93 Length Control = Variable Length



Code 93 Length Control = Fixed Length



Code 93 Set Length 1

This feature specifies one of the bar code lengths for "Code 93 Length Control" on page 184. Length 1 is the minimum label length if in Variable Length Mode, or the first fixed length if in Fixed Length Mode. Length includes the bar code's check and data characters.

The length can be set from 1 to 50 characters. See "Set Length 1" on page 288 for more detailed programming instructions.



Select Code 93 Length 1 Setting

To configure this feature, scan the ENTER/EXIT PROGRAMMING MODE bar code above, then the bar code at left followed by the digits from the Alphanumeric characters in [Appendix D, Keypad](#) representing your desired character(s). End by scanning the ENTER/EXIT bar code again.

Make a mistake? Scan the CANCEL bar code to abort and not save the entry string. You can then start again at the beginning.



CANCEL

★ Length 1 = 01 (one character)

Code 93 Set Length 2

This feature specifies one of the bar code lengths for "Code 93 Length Control" on page 184. Length 2 is the maximum label length if in Variable Length Mode, or the second fixed length if in Fixed Length Mode. The length includes the bar code's check and data characters.

The length can be set from 1 to 50 characters. A setting of 00 specifies to ignore this length (only one fixed length). See "Set Length 2" on page 289 for more detailed programming instructions.



Select Code 93 Length 2 Setting

To configure this feature, scan the ENTER/EXIT PROGRAMMING MODE bar code above, then the bar code at left followed by the digits from the Alphanumeric characters in [Appendix D, Keypad](#) representing your desired character(s). End by scanning the ENTER/EXIT bar code again.

Make a mistake? Scan the CANCEL bar code to abort and not save the entry string. You can then start again at the beginning.



CANCEL

★ Length 2 = 50 (50 characters)



Code 93 Quiet Zones

This feature specifies the number of quiet zones for Code 93 labels. Quiet zones are blank areas at the ends of a bar code and are typically 10 times the width of the narrowest bar or space in the label.



Code 93 Quiet Zones = No Quiet Zones



Code 93 Quiet Zones = Quiet Zone on one side



Code 93 Quiet Zones = Quiet Zones on two sides



★ Code 93 Quiet Zones = Auto



Code 93 Quiet Zones = Virtual Quiet Zones on two sides



MSI

The following options apply to the MSI symbology.

MSI Enable/Disable

Enables/Disables ability of reader to decode MSI labels.



★ MSI = Disable



MSI = Enable

MSI Check Character Calculation

Enables/Disables calculation and verification of an optional MSI check character.



MSI Check Character Calculation = Disable



★ MSI Check Character Calculation = Calculate Mod 10



MSI Check Character Calculation
= Calculate Mod 11/10



MSI Check Character Calculation
= Calculate Mod 10/10



MSI Check Character Transmission

Enables/disables transmission of an MSI check character.



MSI Check Character Transmission = Don't Send



★ MSI Check Character Transmission = Send

MSI Length Control

This feature specifies either variable length decoding or fixed length decoding for the MSI symbology.

Variable Length: For variable-length decoding, a minimum length may be set.

Fixed Length: For fixed-length decoding, two different lengths may be set.



★ MSI Length Control = Variable Length



MSI Length Control = Fixed Length



MSI Set Length 1

This feature specifies one of the bar code lengths for "MSI Length Control" on page 188. Length 1 is the minimum label length if in Variable Length Mode, or the first fixed length if in Fixed Length Mode. Length includes the bar code's data characters only.

The length can be set from 1 to 50 characters. See "Set Length 1" on page 288 for more detailed programming instructions.



Select MSI Length 1 Setting

To configure this feature, scan the ENTER/EXIT PROGRAMMING MODE bar code above, then the bar code at left followed by the digits from the Alphanumeric characters in [Appendix D, Keypad](#) representing your desired character(s). End by scanning the ENTER/EXIT bar code again.

Make a mistake? Scan the CANCEL bar code to abort and not save the entry string. You can then start again at the beginning.



CANCEL

★ Length 1 = 01 (one character)

MSI Set Length 2

This feature specifies one of the bar code lengths for "MSI Length Control" on page 188. Length 2 is the maximum label length if in Variable Length Mode, or the second fixed length if in Fixed Length Mode. The length includes the bar code's data characters only.

The length can be set from 1 to 50 characters. A setting of 00 specifies to ignore this length (only one fixed length). See "Set Length 2" on page 289 for more detailed programming instructions.



Select MSI Length 2 Setting

To configure this feature, scan the ENTER/EXIT PROGRAMMING MODE bar code above, then the bar code at left followed by the digits from the Alphanumeric characters in [Appendix D, Keypad](#) representing your desired character(s). End by scanning the ENTER/EXIT bar code again.

Make a mistake? Scan the CANCEL bar code to abort and not save the entry string. You can then start again at the beginning.



CANCEL

★ Length 2 = 50 (50 characters)



PLESSEY

The following options apply to the Plessey symbology.

Plessey Enable/Disable

Enables/Disables ability of reader to decode Plessey labels.



★ Plessey = Disable



Plessey = Enable

Plessey Check Character Calculation

Enables/Disables calculation and verification of a Plessey check character.



Plessey Check Character Calculation = Disable



★ Plessey Check Character Calculation
= Plessey std check char. verification



Plessey Check Character Calculation
= Anker check char. verification



Plessey Check Character Calculation
= Plessey std and Anker check char. verification



Plessey Check Character Transmission

Enables/disables transmission of a Plessey check character.



Plessey Check Character Transmission = Don't Send



★ Plessey Check Character Transmission = Send

Plessey Length Control

This feature specifies either variable length decoding or fixed length decoding for the Plessey symbology.

Variable Length: For variable-length decoding, a minimum length may be set.

Fixed Length: For fixed-length decoding, two different lengths may be set.



★ Plessey Length Control = Variable Length



Plessey Length Control = Fixed Length



Plessey Set Length 1

This feature specifies one of the bar code lengths for "Plessey Length Control" on page 191. Length 1 is the minimum label length if in Variable Length Mode, or the first fixed length if in Fixed Length Mode. The length includes the bar code's check and data characters.

The length can be set from 1 to 50 characters. See "Set Length 1" on page 288 for more detailed programming instructions.



Select Plessey Length 1 Setting

To configure this feature, scan the ENTER/EXIT PROGRAMMING MODE bar code above, then the bar code at left followed by the digits from the Alphanumeric characters in [Appendix D, Keypad](#) representing your desired character(s). End by scanning the ENTER/EXIT bar code again.

Make a mistake? Scan the CANCEL bar code to abort and not save the entry string. You can then start again at the beginning.



CANCEL

★ Length 1 = 01 (one character)

Plessey Set Length 2

This feature specifies one of the bar code lengths for "Plessey Length Control" on page 191. Length 2 is the maximum label length if in Variable Length Mode, or the second fixed length if in Fixed Length Mode. The length includes the bar code's check and data characters.

Length can be set from 1 to 50 characters. A setting of 00 specifies to ignore this length (only one fixed length). See "Set Length 2" on page 289 for more detailed programming instructions.



Select Plessey Length 2 Setting

To configure this feature, scan the ENTER/EXIT PROGRAMMING MODE bar code above, then the bar code at left followed by the digits from the Alphanumeric characters in [Appendix D, Keypad](#) representing your desired character(s). End by scanning the ENTER/EXIT bar code again.

Make a mistake? Scan the CANCEL bar code to abort and not save the entry string. You can then start again at the beginning.



CANCEL

★ Length 2 = 50 (50 characters)



BC412

The following options apply to the BC412 symbology.

BC412 Enable/Disable

Enables/Disables ability of reader to decode BC412 labels.



★ BC412 = Disable



BC412 = Enable

BC412 Check Character Calculation

Enable this option to enable/disable calculation and verification of an optional BC412 check character. When disabled, any check character in the label is treated as a data character.



BC412 Check Character Calculation = Disable



★ BC412 Check Character Calculation = Calculate



BC412 Length Control

This feature specifies either variable length decoding or fixed length decoding for the BC412 symbology.

Variable Length: For variable-length decoding, a minimum length may be set.

Fixed Length: For fixed-length decoding, two different lengths may be set.



★ BC412 Length Control = Variable Length



BC412 Length Control = Fixed Length



BC412 Set Length 1

This feature specifies one of the bar code lengths for "BC412 Length Control" on page 194. Length 1 is the minimum label length if in Variable Length Mode, or the first fixed length if in Fixed Length Mode. Length includes the bar code's data characters only.

The length can be set from 01 to 50 characters. See "Set Length 1" on page 288 for more detailed programming instructions.



Select BC412 Length 1 Setting

To configure this feature, scan the ENTER/EXIT PROGRAMMING MODE bar code above, then the bar code at left followed by the digits from the Alphanumeric characters in [Appendix D, Keypad](#) representing your desired character(s). End by scanning the ENTER/EXIT bar code again.

Make a mistake? Scan the CANCEL bar code to abort and not save the entry string. You can then start again at the beginning.



CANCEL

★ Length 1 = 01 (one character)

BC412 Set Length 2

This feature specifies one of the bar code lengths for "BC412 Length Control" on page 194. Length 2 is the maximum label length if in Variable Length Mode, or the second fixed length if in Fixed Length Mode. Length includes the bar code's data characters only.

The length can be set from 01 to 50 characters. A setting of 00 specifies to ignore this length (only one fixed length). See "Set Length 2" on page 289 for more detailed programming instructions.



Select BC412 Length 2 Setting

To configure this feature, scan the ENTER/EXIT PROGRAMMING MODE bar code above, then the bar code at left followed by the digits from the Alphanumeric characters in [Appendix D, Keypad](#) representing your desired character(s). End by scanning the ENTER/EXIT bar code again.

Make a mistake? Scan the CANCEL bar code to abort and not save the entry string. You can then start again at the beginning.



CANCEL

★ Length 2 = 50 (50 characters)

CONFIGURATION | 2D SYMBOLOGIES

SECTION CONTENTS

- **2D GLOBAL FEATURES** starting on page 197
- **AZTEC CODE** starting on page 200
- **CHINA SENSIBLE CODE** starting on page 202
- **DATA MATRIX** starting on page 204
- **GS1 DOTCODE** starting on page 207
- **MAXICODE** starting on page 209
- **PDF417** starting on page 212
- **MICRO PDF417** starting on page 214
- **QR CODE** starting on page 217
- **MICRO QR CODE** starting on page 219
- **UCC COMPOSITE** starting on page 221

The reader supports the following 2D symbologies (bar code types). Symbology-dependent options for each symbology are included in this chapter. See "**1D SYMBOLOGIES** starting on page 111" for configuration of 1D bar codes.

2D GLOBAL FEATURES

The following features are common to all, or in some cases, most of the available 2D symbologies. Default settings are indicated at each feature/option with a green arrow. Also reference Appendix B, Standard Defaults for a listing of the most widely used set of standard factory settings. That section also provides space to record any custom settings needed or implemented for your system.

To set most features:

1. Scan the ENTER/EXIT PROGRAMMING bar code at the top of applicable programming pages.
2. Scan the correct bar code to set the desired programming feature or parameter. You may need to cover unused bar codes on the page, and possibly the facing page, to ensure that the reader reads only the bar code you intend to scan.
3. If additional input parameters are needed, go to Appendix D, Keypad, and scan the appropriate characters from the keypad.



NOTE: Additional information about many features can be found in the “References” chapter.

If you make a mistake before the last character, scan the CANCEL bar code to abort and not save the entry string. You can then start again at the beginning.

Complete the programming sequence by scanning the ENTER/EXIT PROGRAMMING bar code to exit Programming Mode.



2D Maximum Decoding Time

This feature specifies the maximum amount of time the software will spend attempting to decode a 2D label. The selectable range is 10 milliseconds to 2.55 milliseconds.



2D Maximum Decoding Time = 100 msec



2D Maximum Decoding Time = 200 msec



★ 2D Maximum Decoding Time = 350 msec



2D Maximum Decoding Time = 500 msec



2D Maximum Decoding Time = 1 Second



2D Maximum Decoding Time = 2 Seconds



2D Maximum Decoding Time = 2.55 Seconds



2D Structured Append

Enables/disables ability of reader to append multiple 2D Codes labels in a structured format. The structured append property is globally applied to the following symbologies, if these are enabled:

- Data Matrix
- Aztec
- QR Code
- PDF 417



★ Structured Append = Disable



Structured Append = Enable

2D Normal/Inverse Symbol Control

Specifies the options available for decoding normal/negative printed 2D symbols. This configuration item applies globally to all the 2D symbologies that support that feature according to Standard AIM Specification: Data Matrix, QR, MicroQR, Aztec and Chinese Sensible Code.



★ Normal/Inverse Symbol Control = Normal



Normal/Inverse Symbol Control = Inverse



Normal/Inverse Symbol Control = Both Normal and Inverse



AZTEC CODE

Aztec Code Enable / Disable

Enables/disables the ability of the reader to decode Aztec Code labels.



Aztec Code = Disable



★ Aztec Code = Enable

Aztec Code Length Control

This feature specifies either variable length decoding or fixed length decoding for this symbology.

Variable Length: For variable length decoding, a minimum and maximum length may be set.

Fixed Length: For fixed length decoding, two different lengths may be set.



★ Aztec Code Length Control = Variable Length



Aztec Code Length Control = Fixed Length



Aztec Code Set Length 1

Specifies one of the bar code lengths for "Aztec Code Length Control" on page 200.

Length 1 is the minimum label length if in Variable Length Mode, or the first fixed length if in Fixed Length Mode. Characters can be set from 0001 to 3,832 characters in increments of 0001 (pad with zeroes).

See "Set Length 1" on page 288 for detailed instructions on setting this feature.



Select Aztec Code Length 1 Setting

To configure this feature, scan the ENTER/EXIT PROGRAMMING MODE bar code above, then the bar code at left followed by the digits from the Alphanumeric characters in [Appendix D, Keypad](#) representing your desired character(s). End by scanning the ENTER/EXIT bar code again.

Make a mistake? Scan the CANCEL bar code to abort and not save the entry string. You can then start again at the beginning.



CANCEL

★0001 = Length 1 is 1 Character

Aztec Code Set Length 2

Specifies one of the bar code lengths for "Aztec Code Length Control" on page 200.

Length 2 is the minimum label length if in Variable Length Mode, or the first fixed length if in Fixed Length Mode. Characters can be set from 0001 to 3,832 characters in increments of 0001 (pad with zeroes).

See "Set Length 2" on page 289 for detailed instructions on setting this feature.



Select Aztec Code Length 2 Setting

To configure this feature, scan the ENTER/EXIT PROGRAMMING MODE bar code above, then the bar code at left followed by the digits from the Alphanumeric characters in [Appendix D, Keypad](#) representing your desired character(s). End by scanning the ENTER/EXIT bar code again.

Make a mistake? Scan the CANCEL bar code to abort and not save the entry string. You can then start again at the beginning.



CANCEL

★Length 2 is 3,832 Characters



CHINA SENSIBLE CODE

China Sensible Code Enable / Disable

Enables/disables the ability of the reader to decode China Sensible Code labels.



★ China Sensible Code = Disable



China Sensible Code = Enable

China Sensible Code Length Control

This feature specifies either variable length decoding or fixed length decoding for this symbology.

Variable Length: For variable length decoding, a minimum and maximum length may be set.

Fixed Length: For fixed length decoding, two different lengths may be set.



★ China Sensible Code Length Control = Variable Length



China Sensible Code Length Control = Fixed Length



China Sensible Code Set Length 1

Specifies one of the bar code lengths for "China Sensible Code Length Control" on page 202. Length 1 is the minimum label length if in Variable Length Mode, or the first fixed length if in Fixed Length Mode. Characters can be set from 0001 to 7,827 characters in increments of 0001 (pad with zeroes).

See "Set Length 1" on page 288 for detailed instructions on setting this feature.



Select China Sensible Code Length 1 Setting

To configure this feature, scan the ENTER/EXIT PROGRAMMING MODE bar code above, then the bar code at left followed by the digits from the Alphanumeric characters in [Appendix D, Keypad](#) representing your desired character(s). End by scanning the ENTER/EXIT bar code again.

Make a mistake? Scan the CANCEL bar code to abort and not save the entry string. You can then start again at the beginning.



CANCEL

★0001 = Length 1 is 1 Character

China Sensible Code Set Length 2

This feature specifies one of the bar code lengths for "China Sensible Code Length Control" on page 202. Length 2 is the maximum label length if in Variable Length Mode, or the second fixed length if in Fixed Length Mode. Characters can be set from 0001 to 7,827 characters in increments of 0001 (pad with zeroes).

See "Set Length 2" on page 289 for detailed instructions on setting this feature.



Select China Sensible Code Length 2 Setting

To configure this feature, scan the ENTER/EXIT PROGRAMMING MODE bar code above, then the bar code at left followed by the digits from the Alphanumeric characters in [Appendix D, Keypad](#) representing your desired character(s). End by scanning the ENTER/EXIT bar code again.

Make a mistake? Scan the CANCEL bar code to abort and not save the entry string. You can then start again at the beginning.



CANCEL

★Length 2 is 7,827 Characters



DATA MATRIX

Data Matrix Enable / Disable

Enables/disables ability of reader to decode Data Matrix labels.



Data Matrix = Disable



★ Data Matrix = Enable

Data Matrix Square/Rectangular Style

Specifies the options available when reading Data Matrix with different form factors.

Choices are:

- Square Style
- Rectangular Style
- Both Square and Rectangular Style

The configuration item can also be configured as a bit mask to filter one or more Data Matrix labels with different symbol size AND shape styles.



Data Matrix Dimensions Mask = Square Style



Data Matrix Dimensions Mask = Rectangular Style



★ Data Matrix Dimensions Mask = Both Square and Rectangular Style



Data Matrix Length Control

This feature specifies either variable length decoding or fixed length decoding for this symbology.

Variable Length: For variable length decoding, a minimum and maximum length may be set.

Fixed Length: For fixed length decoding, two different lengths may be set.



★ Data Matrix Length Control = Variable Length



Data Matrix Length Control = Fixed Length

Data Matrix Set Length 1

This feature specifies one of the bar code lengths for "Data Matrix Length Control" on page 205. Length 1 is the minimum label length if in Variable Length Mode, or the first fixed length if in Fixed Length Mode. Characters can be set from 0001 to 3,116 characters in increments of 0001 (pad with zeroes).

See "Set Length 1" on page 288 for detailed instructions on setting this feature.



Select Data Matrix Length 1 Setting

To configure this feature, scan the ENTER/EXIT PROGRAMMING MODE bar code above, then the bar code at left followed by the digits from the Alphanumeric characters in Appendix D, Keypad representing your desired character(s). End by scanning the ENTER/EXIT bar code again.

Make a mistake? Scan the CANCEL bar code to abort and not save the entry string. You can then start again at the beginning.



CANCEL

★ 0001 = Length 1 is 1 Character



Data Matrix Set Length 2

This feature specifies one of the bar code lengths for "Data Matrix Length Control" on [page 205](#). Length 2 is the maximum label length if in Variable Length Mode, or the second fixed length if in Fixed Length Mode. Characters can be set from 0001 to 3,116 characters in increments of 0001 (pad with zeroes).

See "[Set Length 2](#)" on [page 289](#) for detailed instructions on setting this feature.



Select Data Matrix Length 2 Setting

To configure this feature, scan the ENTER/EXIT PROGRAMMING MODE bar code above, then the bar code at left followed by the digits from the Alphanumeric characters in [Appendix D, Keypad](#) representing your desired character(s). End by scanning the ENTER/EXIT bar code again.

Make a mistake? Scan the CANCEL bar code to abort and not save the entry string. You can then start again at the beginning.



CANCEL

★ Length 2 is 3,116 Characters



GS1 DOTCODE

The following options apply for the DotCode barcode decoding

DotCode Enable

This options enables/disables the ability of the reader to decode DotCode barcodes.



DotCode = Enable



★ DotCode = Disable

DotCode High Resolution Enable

This options improves the decoding performance for very small module size barcodes, e.g. tobacco products.



★ DotCode High Resolution = Enable



DotCode High Resolution = Disable



DotCode Position-based Decoding

This option can improve the decoding performance when the next barcode to be decoded is approximately shown in the same position as the previous one.



DotCode Position-based Decoding = Enable



★ DotCode Position-based Decoding = Disable

Additional Options

To improve performances the following additional settings are available using Aladdin configuration utility, downloadable from www.datalogic.com.

- Dot Size
- Fixed Length or Variable Length
- Min and Max barcode size



MAXICODE

Maxicode Enable / Disable

Enables/disables ability of reader to decode Maxicode labels.



★ Maxicode = Disable



Maxicode = Enable

Maxicode Primary Message Transmission

Enables/disables the transmission of only the Primary Message when the Secondary Message is not readable.



★ Maxicode Primary Message Transmission = Disable



Maxicode Primary Message Transmission = Enable



Maxicode Length Control

This feature specifies either variable length decoding or fixed length decoding for this symbology.

Variable Length: For variable length decoding, a minimum and maximum length may be set.

Fixed Length: For fixed length decoding, two different lengths may be set.



★ Maxicode Length Control = Variable Length



Maxicode Length Control = Fixed Length

Maxicode Set Length 1

Specifies one of the bar code lengths for "Maxicode Length Control" on page 210. Length 1 is the minimum label length if in Variable Length Mode, or the first fixed length if in Fixed Length Mode. Characters can be set from 0001 to 0145 characters in increments of 0001 (pad with zeroes).

See "Set Length 1" on page 288 for detailed instructions on setting this feature.



Select Maxicode Length 1 Setting

To configure this feature, scan the ENTER/EXIT PROGRAMMING MODE bar code above, then the bar code at left followed by the digits from the Alphanumeric characters in Appendix D, Keypad representing your desired character(s). End by scanning the ENTER/EXIT bar code again.

Make a mistake? Scan the CANCEL bar code to abort and not save the entry string. You can then start again at the beginning.



CANCEL

★ 0001 = Length 1 is 1 Character



Maxicode Set Length 2

This feature specifies one of the bar code lengths for "[Maxicode Length Control](#)" on [page 210](#). Length 2 is the maximum label length if in Variable Length Mode, or the second fixed length if in Fixed Length Mode. Characters can be set from 0001 to 0145 characters in increments of 0001 (pad with zeroes).

See "[Set Length 2](#)" on [page 289](#) for detailed instructions on setting this feature.



Select Maxicode Length 2 Setting

To configure this feature, scan the ENTER/EXIT PROGRAMMING MODE bar code above, then the bar code at left followed by the digits from the Alphanumeric characters in [Appendix D, Keypad](#) representing your desired character(s). End by scanning the ENTER/EXIT bar code again.

Make a mistake? Scan the CANCEL bar code to abort and not save the entry string. You can then start again at the beginning.



CANCEL

★ Length 2 is 0145 Characters



PDF417

PDF417 Enable / Disable

Enables/disables the ability of the reader to decode PDF417 labels.



PDF417 = Disable



★ PDF417 = Enable

PDF417 Length Control

This feature specifies either variable length decoding or fixed length decoding for this symbology.

Variable Length: For variable length decoding, a minimum and maximum length may be set.

Fixed Length: For fixed length decoding, two different lengths may be set.



★ PDF417 Length Control = Variable Length



PDF417 Length Control = Fixed Length



PDF417 Set Length 1

Specifies one of the bar code lengths for "PDF417 Length Control" on page 212. Length 1 is the minimum label length if in Variable Length Mode, or the first fixed length if in Fixed Length Mode. Length includes the bar code's data characters only. Characters can be set from 0001 to 2,710 characters (pad with zeroes) in increments of 01. Any value greater than 2,710 will be considered to be 2,710.

See "Set Length 1" on page 288 for detailed instructions on setting this feature.



Select PDF417 Length 1 Setting

To configure this feature, scan the ENTER/EXIT PROGRAMMING MODE bar code above, then the bar code at left followed by the digits from the Alphanumeric characters in Appendix D, Keypad representing your desired character(s). End by scanning the ENTER/EXIT bar code again.

Make a mistake? Scan the CANCEL bar code to abort and not save the entry string. You can then start again at the beginning.



CANCEL

★0001 = Length 1 is 1 Character

PDF417 Set Length 2

This feature specifies one of the bar code lengths for "PDF417 Length Control" on page 212. Length 2 is the maximum label length if in Variable Length Mode, or the second fixed length if in Fixed Length Mode. Length includes the bar code's check, data, and full-ASCII shift characters. The length does not include start/stop characters. Characters can be set from 01 to 2,710 characters (pad with zeroes) in increments of 01. Any value greater than 2,710 will be considered to be 2,710.

See "Set Length 2" on page 289 for detailed instructions on setting this feature.



Select PDF417 Length 2 Setting

To configure this feature, scan the ENTER/EXIT PROGRAMMING MODE bar code above, then the bar code at left followed by the digits from the Alphanumeric characters in Appendix D, Keypad representing your desired character(s). End by scanning the ENTER/EXIT bar code again.

Make a mistake? Scan the CANCEL bar code to abort and not save the entry string. You can then start again at the beginning.



CANCEL

★Length 2 is 2,710 Characters



MICRO PDF417

Micro PDF417 Enable / Disable

Enables/disables the ability of the reader to decode Micro PDF417 labels.



Micro PDF417 = Disable



★ Micro PDF417 = Enable

Micro PDF417 Code 128 GS1-128 Emulation

Specifies which AIM ID to use for Micro PDF labels when doing Code 128 or GS1-128 emulation.

Emulation choices are:

- Micro PDF AIM ID and label type
- Code 128 / EAN128 AIM Id and label type.



★ Micro PDF417 Code 128 GS1-128 Emulation =
Micro PDF AIM ID and label type



Micro PDF417 Code 128 GS1-128 Emulation =
Code 128 / EAN128 AIM ID and label type



Micro PDF417 Length Control

This feature specifies either variable length decoding or fixed length decoding for this symbology.

Variable Length: For variable length decoding, a minimum and maximum length may be set.

Fixed Length: For fixed length decoding, two different lengths may be set.



★ Micro PDF417 Length Control = Variable Length



Micro PDF417 Length Control = Fixed Length

Micro PDF417 Set Length 1

Specifies one of the bar code lengths for "Micro PDF417 Length Control" on page 215. Length 1 is the minimum label length if in Variable Length Mode, or the first fixed length if in Fixed Length Mode. Length includes the bar code's data characters only. Characters can be set from 0001 to 0366 characters (pad with zeroes) in increments of 01. Any value greater than 0366 will be considered to be 0366.

See "Set Length 1" on page 288 for detailed instructions on setting this feature.



Select Micro PDF417 Length 1 Setting

To configure this feature, scan the ENTER/EXIT PROGRAMMING MODE bar code above, then the bar code at left followed by the digits from the Alphanumeric characters in [Appendix D, Keypad](#) representing your desired character(s). End by scanning the ENTER/EXIT bar code again.

Make a mistake? Scan the CANCEL bar code to abort and not save the entry string. You can then start again at the beginning.



CANCEL

★ 0001 = Length 1 is 1 Character



Micro PDF417 Set Length 2

This feature specifies one of the bar code lengths for "Micro PDF417 Length Control" on [page 215](#). Length 2 is the maximum label length if in Variable Length Mode, or the second fixed length if in Fixed Length includes the bar code's data characters only. Characters can be set from 0001 to 0366 characters (pad with zeroes) in increments of 01. Any value greater than 0366 will be considered to be 0366.

See "[Set Length 2](#)" on [page 289](#) for detailed instructions on setting this feature.



Select Micro PDF417 Length 2 Setting

To configure this feature, scan the ENTER/EXIT PROGRAMMING MODE bar code above, then the bar code at left followed by the digits from the Alphanumeric characters in [Appendix D, Keypad](#) representing your desired character(s). End by scanning the ENTER/EXIT bar code again.

Make a mistake? Scan the CANCEL bar code to abort and not save the entry string. You can then start again at the beginning.



CANCEL

★ Length 2 is 0366 Characters



QR CODE

QR Code Enable / Disable

Enables/disables the ability of the reader to decode QR Code labels.



QR Code = Disable



★ QR Code = Enable

QR Code Length Control

This feature specifies either variable length decoding or fixed length decoding for this symbology.

Variable Length: For variable length decoding, a minimum and maximum length may be set.

Fixed Length: For fixed length decoding, two different lengths may be set.



★ QR Code Length Control = Variable Length



QR Code Length Control = Fixed Length



QR Code Set Length 1

This feature specifies one of the bar code lengths for "QR Code Length Control" on page 217. Length 1 is the minimum label length if in Variable Length Mode, or the first fixed length if in Fixed Length Mode. Characters can be set from 0001 to 7,089 characters in increments of 0001 (pad with zeroes).

See "Set Length 1" on page 288 for detailed instructions on setting this feature.



Select QR Code Length 1 Setting

To configure this feature, scan the ENTER/EXIT PROGRAMMING MODE bar code above, then the bar code at left followed by the digits from the Alphanumeric characters in Appendix D, Keypad representing your desired character(s). End by scanning the ENTER/EXIT bar code again.

Make a mistake? Scan the CANCEL bar code to abort and not save the entry string. You can then start again at the beginning.



CANCEL

★ 0001 = Length 1 is 1 Character

QR Code Set Length 2

This feature specifies one of the bar code lengths for "QR Code Length Control" on page 217. Length 2 is the maximum label length if in Variable Length Mode, or the second fixed length if in Fixed Length Mode. Characters can be set from 0001 to 7,089 characters in increments of 0001 (pad with zeroes).

See "Set Length 2" on page 289 for detailed instructions on setting this feature.



Select QR Code Length 2 Setting

To configure this feature, scan the ENTER/EXIT PROGRAMMING MODE bar code above, then the bar code at left followed by the digits from the Alphanumeric characters in Appendix D, Keypad representing your desired character(s). End by scanning the ENTER/EXIT bar code again.

Make a mistake? Scan the CANCEL bar code to abort and not save the entry string. You can then start again at the beginning.



CANCEL

★ Length 2 is 7,089 Characters



MICRO QR CODE

Micro QR Code Enable / Disable

Enables/disables the ability of the reader to decode Micro QR Code labels.



★ Micro QR Code = Disable



Micro QR Code = Enable

Micro QR Code Length Control

This feature specifies either variable length decoding or fixed length decoding for this symbology.

Variable Length: For variable length decoding, a minimum and maximum length may be set.

Fixed Length: For fixed length decoding, two different lengths may be set.



★ Micro QR Code Length Control = Variable Length



Micro QR Code Length Control = Fixed Length



Micro QR Code Set Length 1

This feature specifies one of the bar code lengths for "[Micro QR Code Length Control](#)" on [page 219](#). Length 1 is the minimum label length if in Variable Length Mode, or the first fixed length if in Fixed Length Mode. Characters can be set from 0001 to 0035 characters in increments of 0001 (pad with zeroes).

See "[Set Length 1](#)" on [page 288](#) for detailed instructions on setting this feature.



Select Micro QR Code Length 1 Setting

To configure this feature, scan the ENTER/EXIT PROGRAMMING MODE bar code above, then the bar code at left followed by the digits from the Alphanumeric characters in [Appendix D, Keypad](#) representing your desired character(s). End by scanning the ENTER/EXIT bar code again.

Make a mistake? Scan the CANCEL bar code to abort and not save the entry string. You can then start again at the beginning.



CANCEL

★ 0001 = Length 1 is 1 Character

Micro QR Code Set Length 2

This feature specifies one of the bar code lengths for "[Micro QR Code Length Control](#)" on [page 219](#). Length 2 is the maximum label length if in Variable Length Mode, or the second fixed length if in Fixed Length Mode. Characters can be set from 0001 to 0035 characters in increments of 0001 (pad with zeroes).

See "[Set Length 2](#)" on [page 289](#) for detailed instructions on setting this feature.



Select Micro QR Code Length 2 Setting

To configure this feature, scan the ENTER/EXIT PROGRAMMING MODE bar code above, then the bar code at left followed by the digits from the Alphanumeric characters in [Appendix D, Keypad](#) representing your desired character(s). End by scanning the ENTER/EXIT bar code again.

Make a mistake? Scan the CANCEL bar code to abort and not save the entry string. You can then start again at the beginning.



CANCEL

★ Length 2 is 0035 Characters



UCC COMPOSITE

UCC Optional Composite Timer

Specifies the amount of time the system will wait for the stacked part of a UCC Composite label before transmitting the linear label without an add-on. The UCC Optional Composite Timer can be set within a range of 10 to 300 msec. A setting of 0 disables the timer.



UCC Optional Composite Timer = Timer Disabled



★ UCC Optional Composite Timer = 70 msec



UCC Optional Composite Timer = 100 msec



UCC Optional Composite Timer = 200 msec



UCC Optional Composite Timer = 300 msec



Postal Code Selection

Enables/disables the ability of the reader to decode labels of a specific postal symbol-ogy.

- Disable All Postal Codes
- Postnet
- Planet
- Royal Mail
- Kix
- Australia Post
- Japan Post
- IMB
- Sweden Post
- Portugal Post



★ Postal Code Selection = Disable All Postal Codes



Postal Code Selection = Enable Postnet



Postal Code Selection = Enable Planet



Postal Code Selection = Enable Royal Mail



Postal Code Selection = Enable Kix



Postal Code Selection = Enable Australia Post



Postal Code Selection = Enable Japan Post



Postal Code Selection (continued)



Postal Code Selection = Enable IMB



Postal Code Selection = Enable Sweden Post



Postal Code Selection = Enable Portugal Post

Postnet BB Control

Controls the ability of the reader to decode B and B' fields of Postnet labels.



★ Postnet BB Control = Disable



Postnet BB Control = Enable

CONFIGURATION | OCR DECODING

The QX25 bar code family is equipped with an Optical Character Recognition feature.

This section describes how to configure the Datalogic bar code reader to enable OCR decoding.

The QX25 models support the following OCR font types:

- OCR-A
- OCR-B
- MICR E13B
- US Currency Serial Number.

In most OCR applications a suitable usage of check digits and the addition of constraints on sub-strings types (e.g. digits-only or letter-only) reduces misdecoding probabilities.

The user can choose between a set of predefined templates (already optimized for decoding) and customizable free templates.

For free templates, as OCR decoding is less reliable than traditional barcode decoding, the reader provides tools to minimize misdecoded labels. As a result, particular care shall be dedicated to the setup of free custom templates to reduce incorrect output.

For more information on how to customize the user templates for your needs, please contact Datalogic Technical Support.

Use one of the following labels to enable one of the predefined templates for OCR decoding.



OCR Decoding Predefined Templates

The following selections are exclusive, enabling one template automatically disables the others.



★ OCR Predefined Template = Disable OCR Function



OCR Predefined Template = EU Identity Card OCR



OCR Predefined Template = IATA Passport OCR



OCR Predefined Template = Italian Post OCR Payment



OCR Predefined Template = Italian Bank
Freccia Bank Payment form



OCR Predefined Template = Swiss Driving License OCR

CONFIGURATION | MOTION FEATURES

SECTION CONTENTS

MOTION FEATURES starting on page 226

- Motionless Timeout
- Motion Sensitivity
- High Motion Immunity
- Motion Aiming Control
- DOF Enhancement (Not available for QW2500)
-

Use this chapter to configure motion settings for the handheld.
Reference Appendix B, for a listing of standard factory settings.



Motionless Timeout

The period of time that must expire without detecting any motion, before the reader is assumed to be in a motionless condition. The selectable setting is from 500 to 25,500 milliseconds in 100 millisecond increments. This option relates to such features as Aimer On and Stand Mode/Object Detection scanning with respect to motion.



Select Motionless Timeout

To configure this feature, scan the ENTER/EXIT PROGRAMMING MODE bar code above, then the bar code at left followed by the digits from the Alphanumeric characters in [Appendix D, Keypad](#) representing your desired character(s). End by scanning the ENTER/EXIT bar code again.

Make a mistake? Scan the CANCEL bar code to abort and not save the entry string. You can then start again at the beginning.



CANCEL

★ 020 = Motionless Timeout = 2 seconds

Motion Sensitivity

Sets the sensitivity level for motion detection wakeup. Choices are low, medium and high.



Motion Sensitivity = Low



★ Motion Sensitivity = Medium



Motion Sensitivity = High



High Motion Immunity

When set to triggerless scanning mode (e.g. Flashing, Always On, Stand Mode/Object Detection, etc.) the reading capabilities can be modified according to two main goals:

- increased performance for rapidly moving barcodes - Enable High Motion Immunity:
- increased performance for distant barcodes - Disable High Motion Immunity:

Depending on specific environmental conditions, application requirements, or expected performance, choose the best solution.



High Motion Immunity = Disable



★ High Motion Immunity = Enable

Motion Aiming Control

Enables/Disables the Aiming system when motion is detected.



Motion Aiming Control = Disable



★ Motion Aiming Control = Enable



DOF Enhancement (Not available for QW2500)

When DOF Enhancement is enabled improves the reading performances.



★ Enhance product DOF = Disable



Enhance product DOF = Enable



Enhance product DOF = Auto

CONFIGURATION | POWER MANAGEMENT

SECTION CONTENTS

POWER SAVE starting on page 231

- Powerdown Timeout

BATTERY PROFILES starting on page 232

- Battery Profiles
- Battery Information

These parameters refer to Mobile units only.



POWER SAVE

Powerdown Timeout

The Powerdown Timeout feature sets the time for automatically switching the unit off when the imager has been idle.



Powerdown Timeout = Disable



Powerdown Timeout = 10 minutes



Powerdown Timeout = 20 minutes



★ Powerdown Timeout = 30 minutes



Powerdown Timeout = 60 minutes (1 hour)



Powerdown Timeout = 120 minutes (2 hours)



BATTERY PROFILES

Battery Profiles

QuickScan 2500 provides the user the ability to select different usage profiles to better configure the reader with respect to specific needs. By default, the Maximum Performance profile is selected and provides high snappiness and max reading capability. The user can then decide to exploit specific features when others are considered less important, for instance: fast battery recharge instead of battery health, maximum reading performance instead of battery autonomy, etc.

The following Battery Profiles are described with associated benefits and limitations:



★ Battery Profile = Maximum Performance



Battery Profile = Maximum Battery Health



Battery Profile = Maximum Autonomy



Battery Profile = Fast Charge

**Maximum Performance (default)**

- Reader autonomy for heavy workload
- Motionix™ enabled
- Max radio communication performances

**Maximum Battery Health**

- Battery capacity is preserved
- Reduced max charging current
- Reduced battery capacity by ~20%
- Increased recharge time: +20% on average (it depends on the specific reader configuration)

**Maximum Autonomy**

- Max reader autonomy
- Motionix™ disabled
- Reduced Radio Star™ responsiveness
- Increased Sniff-time period (Bluetooth®)

**Fast Charge**

- Reduced recharge time (approx. 20%)
- Motionix™ disabled
- Scan-While-Charging disabled (Trigger Single)

Battery Information

By using Datalogic Aladdin utility, additional battery data can be retrieved, i.e.:

- HH Serial Number
- Charge %
- Health %
- Full Charge Capacity
- Designed Capacity
- Nominal Capacity
- Remaining Capacity
- Discharging Counter
- Charging Status
- Charging (base station) Battery Voltage
- Battery Current

CONFIGURATION | WIRELESS FEATURES

SECTION CONTENTS

WIRELESS BEEPER FEATURES starting on page 235

- Good Transmission Beep
- Beeper Frequency
- Beep Duration
- Beep Volume
- Disconnect Beep
- Docking (Connecting) Beep
- Leash Alarm

CONFIGURATION UPDATES starting on page 240

- Automatic Configuration Update
- Copy Configuration to Reader
- Copy Configuration to Base Station

BATCH FEATURES starting on page 241

- Batch Mode
- Send Batch
- Erase Batch Memory
- RF Batch Mode Transmit Delay

DIRECT RADIO AUTOLINK starting on page 243

- Direct Radio Autolink

RF ADDRESS STAMPING starting on page 244

- Source Radio Address Transmission
- Source Radio Address Delimiter Character

BLUETOOTH-ONLY FEATURES starting on page 245

- Bluetooth Security Level
- Wi-Fi Channels Exclusion
- Bluetooth Discoverable Mode Timeout
- Bluetooth Friendly Name

BLUETOOTH HID FEATURES starting on page 254

- Bluetooth HID Alt Mode



WIRELESS BEEPER FEATURES

Several options are available to configure beeper behavior for wireless operation.

Good Transmission Beep

Enables/disables the Good Transmission Beep indication. When enabled, a beep occurs when a Label is correctly transmitted to the base.



Good Transmission Beep = Disable



★ Good Transmission Beep = Enable

Beeper Frequency

Adjusts radio-specific beep indications to sound at a low, medium or high frequency, selectable from the list below (controls the beeper's pitch/tone).



★ Beeper Frequency = Low



Beeper Frequency = Medium



Beeper Frequency = High



Beep Duration

This feature controls the duration of radio-specific beep indications.



Beep Duration = 60 msec



★ Beep Duration = 80 msec



Beep Duration = 100 msec



Beep Duration = 120 msec



Beep Duration = 140 msec



Beep Duration = 160 msec



Beep Duration = 180 msec



Beep Duration = 200 msec



Beep Volume

Selects the beeper volume (loudness) of radio-specific beep indications. There are three selectable volume levels.



Beep Volume = Low



Beep Volume = Medium



★ Beep Volume = High

Disconnect Beep

Enables/disables the beep indication that a handheld has become disconnected from a Base Station.



Disconnect Beep = Disable



★ Disconnect Beep = Enable



Docking (Connecting) Beep

Enables/disables a beep indication when the handheld is placed in the Base Station.



Docking Beep = Disable



★ Docking Beep = Enable

Leash Alarm

This setting specifies the number of seconds to sound the Leash Mode beeps (three per second) when the handheld goes out of range. This is especially useful in instances where the reader might inadvertently have been placed in a bag or cart.

For this mode to be effective, the reader must be linked to the Base Station. If the reader is asleep or disconnected from the Base Station, there is no way for it to know where it is relative to the Base Station because communication is not active between the devices.



★ Leash Alarm = Disable



Leash Alarm = 1 Second



Leash Alarm = 2 Seconds



Leash Alarm = 3 Seconds



Leash Alarm (continued)



Leash Alarm = 4 Seconds



Leash Alarm = 5 Seconds



Leash Alarm = 10 Seconds



Leash Alarm = 25 Seconds



Leash Alarm = 30 Seconds



CONFIGURATION UPDATES

Automatic Configuration Update

When this feature is enabled, a reader and its linked Base Station can automatically ensure they stay in sync with regard to application hardware and/or configuration. See [page 286](#) for more information on this feature.



Automatic Configuration Update = Disable



★ Automatic Configuration Update = Enable

Copy Configuration to Reader

Scan the following label to copy the current Base Station configuration to the reader. Use this method when the Auto Configuration Update feature is disabled and you want a one-time configuration update to be performed on the reader.



NOTE: Do not scan an ENTER/EXIT PROGRAMMING MODE label in conjunction with this bar code.



Copy Configuration to Reader

Copy Configuration to Base Station

Scan the following label to copy the current reader configuration to the Base Station. Use this method when the Auto Configuration Update feature is disabled and you want a one-time configuration update to be performed on the Base Station.



NOTE: Do not scan an ENTER/EXIT PROGRAMMING MODE label in conjunction with this bar code.



Copy Configuration to Base Station



BATCH FEATURES

Batch Mode

This option specifies whether to store labels in the handheld while disconnected from the base. Options are as follows:

- Disabled — The handheld will not store/batch labels.
- Automatic — The handheld will store labels to RAM when the handheld goes out of range and is disconnected from the remote device.
- Manual — The handheld will always store labels to Flash memory. The user must manually send the stored labels to the remote device using a special "batch send" label.



★ Batch Mode = Disable



Batch Mode = Automatic



Batch Mode = Manual

Send Batch

When the reader is configured in Manual Batch Mode, use the following bar code to initiate sending of labels stored in batch memory.



NOTE: Do not scan an ENTER/EXIT PROGRAMMING MODE label in conjunction with this bar code.



Send Batch



Erase Batch Memory

When the reader is configured in Manual Batch Mode, use the following bar code to erase any labels stored in batch memory.



NOTE: Do not scan an ENTER/EXIT PROGRAMMING MODE label in conjunction with this bar code.



Erase Batch Memory

RF Batch Mode Transmit Delay

Specifies the delay in 10 msec increments between transmitting labels stored in batch memory.



★ RF Batch Mode Transmit Delay = No Delay



RF Batch Mode Transmit Delay = 50 msec



RF Batch Mode Transmit Delay = 100 msec



RF Batch Mode Transmit Delay = 0.5 seconds



RF Batch Mode Transmit Delay = 1 second



RF Batch Mode Transmit Delay = 2.5 seconds



DIRECT RADIO AUTOLINK

Direct Radio Autolink

This feature enables/disables the ability to link a wireless handheld to a base station without scanning the Unlink label first.



★ Direct Radio Link = Unlink Label Required



Direct Radio Link = Automatic Unlinking



RF ADDRESS STAMPING

These features allow configuration of source radio data inclusion.

Source Radio Address Transmission

Enables/disables the ability of source radio address information to be transmitted to the host and, if so, at what position with respect to the label data. See [page 286](#) in “References” for detailed information and examples for setting this feature.



NOTE: When included as a prefix, the source-radio ID is displayed after all label formatting has been applied. The 6 byte hex address is sent as 12 ASCII characters, i.e., an address of 00 06 66 00 1A ED will be sent as (shown in hex): 30 30 30 36 36 36 30 30 31 41 45 44



★ Source Radio Address Transmission =
Do Not Include



Source Radio Address Transmission = Prefix

Source Radio Address Delimiter Character

This option specifies the delimiter character to be placed between the label data and radio address when address stamping is enabled.



NOTE: This feature only applies if "Source Radio Address Transmission" on [page 244](#) is enabled.



Set Source Radio Address Delimiter Character

To configure this feature, scan the ENTER/EXIT PROGRAMMING MODE bar code above, then the bar code at left followed by the digits from the Alphanumeric characters in [Appendix D, Keypad](#) representing your desired character(s). End by scanning the ENTER/EXIT bar code again.

Make a mistake? Scan the CANCEL bar code to abort and not save the entry string. You can then start again at the beginning.



CANCEL

★ Delimiter Character = 00 (no delimiter character)



BLUETOOTH-ONLY FEATURES

The features in this section are valid only for QuickScan™ Bluetooth models.



NOTE: Changing the configuration parameters described in this section may cause a temporary loss of the Bluetooth connection between the Reader and the remote device.

Bluetooth Security Level



NOTE: This parameter applies when pairing the Reader with a third party Bluetooth device. It has no effect when linking the Reader to a Base station.

Set this parameter according to the security requirements of the application scenario when the reader will be employed.

- Select Level 1 - lowest when the main application requirement is to avoid any user interaction (e.g. Passkey or PIN entry) during the pairing process. When using this setting, the resulting Bluetooth connection will be encrypted but not authenticated.
- Select Level 2 when encryption is required, authentication is not required, and minimal user interaction is desired. In this case the Host may ask the user to enter a 6-digit Bluetooth Passkey during the pairing process.
- Select Level 3 - highest when a secure connection to the Host is desired, with both encryption and authentication. In this case the Host will ask the user to enter a 6-digit Bluetooth Passkey or a Bluetooth PIN during the pairing process.



NOTE: When device authentication takes place during the pairing process, by means of the passkey or PIN entry, the resulting Bluetooth link is protected from Man-In-The-Middle (MITM) malicious attacks.



NOTE: The actual behaviors of the Reader and of the Host system during the pairing process depend on the security settings of both devices involved, and on the input and output means available on each device to interface with the user.

This means that:

- the user may be required to enter a BT Passkey during the pairing process even if the reader's BT Security Level is set to "Encryption required, authentication not required". This depends on the configuration of the Host system.
- when the reader's BT Security Level is set to "Encryption and authentication required", it may not be possible to connect to a Host system if the latter cannot support the Passkey Entry authentication procedure. In this case, try to set the reader's BT Security Level to "Encryption required, authentication not required" to establish the connection.



NOTE: Changing the BT Security Level setting will unlink the Reader from the remote device.



★ BT Security Level = Level 1 - lowest



BT Security Level = Level 2



BT Security Level = Level 3 - highest



Wi-Fi Channels Exclusion

In case the Reader operates in the same environment as 2.4 GHz Wi-Fi equipment, set this parameter to configure the strategy that the Reader should employ to minimize the interferences between Bluetooth and Wi-Fi wireless technologies.

- If the specific 802.11 standard or the frequency channels used by the Wi-Fi equipment are unknown, select Automatic to let the Reader use the Adaptive Frequency Hopping (AFH) feature of Bluetooth technology. With this setting, the Reader and the remote Bluetooth device may automatically detect the frequency channels affected by a significant level of interference, and avoid using these channels during Bluetooth data exchange.
- If the specific 802.11 standard and the frequency channels used by the Wi-Fi equipment are known, select the corresponding combination from the list of programming labels below or use the Datalogic Aladdin tool. With this setting, the Reader and the remote Bluetooth device avoid using the Bluetooth frequency channels that overlap with the already occupied Wi-Fi channels.

For example, if the co-located 2.4 GHz Wi-Fi equipment operates according to the 802.11g standard on channels n. 6 and n. 11, read the 802.11b/g ch.6 and 11 programming label.



NOTE: The programming labels in the list below cover the most popular combinations of 802.11 standards and 2.4 GHz Wi-Fi channels. If the configuration command corresponding to your specific scenario is not listed, please contact Datalogic Technical Support for further configuration options.



★ WiFi Ch. Exclusion = Automatic



WiFi Ch. Exclusion = 802.11b_g ch.1



WiFi Ch. Exclusion = 802.11b_g ch.2



WiFi Ch. Exclusion = 802.11b_g ch.3



Wi-Fi Channels Exclusion (continued)



WiFi Ch. Exclusion = 802.11b_g ch.4



WiFi Ch. Exclusion = 802.11b_g ch.5



WiFi Ch. Exclusion = 802.11b_g ch.6



WiFi Ch. Exclusion = 802.11b_g ch.7



WiFi Ch. Exclusion = 802.11b_g ch.8



WiFi Ch. Exclusion = 802.11b_g ch.9



WiFi Ch. Exclusion = 802.11b_g ch.10



WiFi Ch. Exclusion = 802.11b_g ch.11



Wi-Fi Channels Exclusion (continued)



WiFi Ch. Exclusion = 802.11b_g ch.12



WiFi Ch. Exclusion = 802.11b_g ch.13



WiFi Ch. Exclusion = 802.11b_g ch.14



WiFi Ch. Exclusion = 802.11b_g ch.1 and 6



WiFi Ch. Exclusion = 802.11b_g ch.1 and 11



WiFi Ch. Exclusion = 802.11b_g ch.6 and 11



WiFi Ch. Exclusion = 802.11b_g ch.1 and 6 and 11



WiFi Ch. Exclusion = 802.11b_g ch.2 and 7



Wi-Fi Channels Exclusion (continued)



WiFi Ch. Exclusion = 802.11b_g ch.2 and 12



WiFi Ch. Exclusion = 802.11b_g ch.7 and 12



WiFi Ch. Exclusion = 802.11b_g ch.2 and 7 and 12



WiFi Ch. Exclusion = 802.11b_g ch.3 and 8



WiFi Ch. Exclusion = 802.11b_g ch.3 and 13



WiFi Ch. Exclusion = 802.11b_g ch.8 and 13



WiFi Ch. Exclusion = 802.11b_g ch.3 and 8 and 13



WiFi Ch. Exclusion = 802.11b_g ch.4 and 9



Wi-Fi Channels Exclusion (continued)



WiFi Ch. Exclusion = 802.11b_g ch.4 and 14



WiFi Ch. Exclusion = 802.11b_g ch.9 and 14



WiFi Ch. Exclusion = 802.11b_g ch.4 and 9 and 14



WiFi Ch. Exclusion = 802.11b_g ch.5 and 10



WiFi Ch. Exclusion = 802.11n ch.3



WiFi Ch. Exclusion = 802.11n ch.11



Bluetooth Discoverable Mode Timeout

It defines how long the scanner is discoverable after reading the "Link HID" or "Link SPP" label.



Discoverable Mode Timeout = 1 minute



Discoverable Mode Timeout = 2 minutes



★ Discoverable Mode Timeout = 3 minutes



Discoverable Mode Timeout = 4 minutes



Discoverable Mode Timeout = 5 minutes



Bluetooth Friendly Name

You can set a meaningful name for QBT2500 that will appear in the application during device discovery.

To set a new Bluetooth Friendly Name, scan the barcode below and follow the instructions.



Set Bluetooth Friendly Name

To configure this feature, scan the ENTER/EXIT PROGRAMMING MODE bar code above, then the bar code at left followed by a maximum 64 digits from the Alphanumeric characters in [Appendix D, Keypad](#). The digits must be the hexadecimal ASCII representation of the desired characters. If less than the expected string of 32 characters are selected, scan the ENTER/EXIT bar code to terminate the string.

Make a mistake? Scan the CANCEL bar code to abort and not save the entry string. You can then start again at the beginning.



CANCEL

★ QUICKSCAN QBT2500 [SERIAL_NUMBER_SCANNER]



BLUETOOTH HID FEATURES

Before connecting the Reader to a Bluetooth HID host device, the keyboard emulation used for label transmission can be configured using the parameters described in this section, plus the following parameters:

- "Setting Country Mode" on page 45
- "Encoding Type" on page 59
- "ALT Output Type" on page 66
- "Keyboard Numeric Keypad" on page 68
- "Keyboard Send Control Characters" on page 68

Bluetooth HID Alt Mode

Enable/Disable the ability to correctly transmit a label to the host regardless of the Bluetooth HID Country Mode selected, when Bluetooth HID Profile is configured.

Read the configuration command label below for the HID Alt Mode feature.



★ HID Alt Mode = OFF



HID Alt Mode = ON



FEATURES FOR STAR MODELS ONLY

The features in this section are valid only for the Quickscan | QM250X Star model:

- "STAR Radio Protocol Timeout" on page 255
- "STAR Radio Transmit Mode" on page 256

STAR Radio Protocol Timeout

This parameter sets the valid wait time before transmission between the handheld reader and Base Station is considered failed.

When setting this parameter, take into consideration the radio traffic (number of readers in the same area). The selectable range for this feature is from 02 to 25 seconds. See [page 287](#) in "References" for detailed information and examples for setting this feature.



Set Radio Protocol Timeout

To configure this feature, scan the ENTER/EXIT PROGRAMMING MODE bar code above, then the bar code at left followed by the digits from the Alphanumeric characters in [Appendix D, Keypad](#) representing your desired character(s). End by scanning the ENTER/EXIT bar code again.

Make a mistake? Scan the CANCEL bar code to abort and not save the entry string. You can then start again at the beginning.



CANCEL

★ Radio Protocol Timeout = 02 (2 seconds)



STAR Radio Transmit Mode

Specifies the transmission protocol for Star communications.

Options are:

- ACK from cradle to scanner — signals a good transmission as soon as the Base Station receives a label
- ACK when sent to host — scanner signals a good transmission as soon as the Base Station has sent the label to the host
- ACK from host — scanner signals a good transmission as soon as the Base Station has sent the label to the host and host has replied with an acknowledge message.



★ STAR Radio Transmit Mode =
ACK from Base Station



STAR Radio Transmit Mode = ACK When Sent to Host



STAR Radio Transmit Mode = ACK from Host



NOTE: ACK from host works only for RS-232 or USB-COM interfaces with ACK/NACK disabled. If ACK from host is configured with any other interface conditions, it works like ACK when sent to host.

See “Message Formatting” on page 290. for details.



NOTE: The Base Station can receive a host message only if Host Commands Obey/Ignore (page 29) is set to Ignore.



STAR System Speed

By default, the Reader and the Base exchange data at high speed over the wireless communication channel. Reducing the speed from high to low, the radio range can be further extended. Moreover, when using low speed, the Reader can be configured to use the STAR Frequency Agility feature (see "STAR Frequency Agility" on page 258) also for the 433 MHz model (see Table 5 on page 259).

To change the STAR System Speed, follow this procedure:

1. link the Reader to the Base;
2. scan the ENTER/EXIT PROGRAMMING MODE bar code above; read either the "High speed" or "Low speed" programming label below to set the desired speed; end by scanning the ENTER/EXIT bar code again.
3. place the Reader into the Base.

The Reader and the Base will now be linked at the new programmed speed.

This feature can also be programmed using the Datalogic Aladdin tool:

1. set the STAR System Speed to "High speed" or "Low speed" through Aladdin;
2. place an unlinked Reader into the Base.

The Reader and the Base will link at the new programmed speed.



NOTE: Quickscan Star 433 MHz models do not support all combinations of STAR System Speed and STAR Frequency Agility (see "STAR Frequency Agility" on page 258) configuration parameters. Please refer to Table 5 on page 259 for the allowed combinations.



★ STAR System Speed = High Speed



STAR System Speed = Low Speed



STAR Frequency Agility

In exceptionally noisy environments or in case of a high concentration of radio devices, the STAR system performance may be improved by enabling the STAR Frequency Agility feature. This feature changes the way the radio frequencies are used in a STAR communication system.

As in the case of the STAR System Speed, use the following procedure:

1. link the Reader to the Base;
2. scan the ENTER/EXIT PROGRAMMING MODE bar code above; read either the "Enable" or "Disable" programming label below to Enable or Disable the feature; end by scanning the ENTER/EXIT bar code again.
3. place the Reader into the Base.

The Reader and the Base will be linked and the new frequency handling strategy will be operational.



NOTE: It is possible to configure the STAR system to use a fixed channel with different frequency from the default one. Please contact Datalogic Technical Support for information about this feature. Please refer to Table 5 on page 259 for valid combinations of this feature with the STAR System Speed configuration parameter.



NOTE: Quickscan Star 433 MHz models do not support all combinations of STAR Frequency Agility and STAR System Speed (see "STAR System Speed" on page 257) configuration parameters. Please refer to Table 5 on page 259 for the allowed combinations.



★ STAR Frequency Agility = Disable
(use default fixed channel)



STAR Frequency Agility = Enable

Table 5 Supported combinations of STAR System Speed and STAR Frequency Agility configuration parameters

SYSTEM SPEED	FREQUENCY AGILITY	FIXED CHANNEL DIFFERENT FROM DEFAULT
433 MHz Model		
Low Speed	Yes	Yes
High Speed	No	No
910 MHz Model		
Low Speed	Yes	Yes
High Speed	Yes	Yes

CHAPTER 4

REFERENCES

This section contains explanations and examples of selected bar code features. See "Configuration with Bar Codes" on page 27 for the actual bar code labels.

SECTION CONTENTS

RS-232 PARAMETERS on page 261

- Baud Rate
- Data Bits
- Stop Bits
- Parity
- Handshaking Control

RS-232/USB COM PARAMETERS on page 262

- Intercharacter Delay
- ACK NAK Options
- ACK Character
- NAK Character
- ACK NAK Timeout Value
- ACK NAK Retry Count
- Disable Character
- Enable Character

KEYBOARD INTERFACE (NOT AVAILABLE FOR QW2500/QD2520) on page 269

- Wedge Quiet Interval
- Intercharacter Delay
- Intercode Delay

DATA FORMAT on page 272

- Data Editing
- Global Prefix/Suffix
- Global AIM ID
- Label ID
- Character Conversion

SCANNING FEATURES on page 280

- Scan Mode
- Scanning Active Time
- Aiming Duration Time
- Flash On Time
- Flash Off Time

LED AND BEEPER INDICATORS on page 285

- Good Read LED Duration

RF FEATURES on page 286

- Automatic Configuration Update
- RF Address Stamping
- STAR Radio Protocol Timeout

SYMBOLOGIES on page 288

- Set Length

RS-232 PARAMETERS

RS-232 ONLY

Not available for QW2500 and QD2520

Baud Rate

Baud rate is the number of bits of data transmitted per second. Set the reader's baud rate to match the baud rate setting of the host device. With an improper baud rate setting, data may not reach the host correctly.

Data Bits

This parameter allows the reader to interface with devices requiring a 7-bit or 8-bit ASCII protocol for sending and receiving data.

Stop Bits

The stop bit(s) at the end of each transmitted character marks the end of transmission of one character and prepares the receiving device for the next character in the serial data stream. The number of stop bits selected (one or two) depends on the number the receiving terminal is programmed to accommodate. Set the number of stop bits to match host device requirements.

Parity

This feature specifies parity required for sending and receiving data. A parity check bit is the most significant bit of each ASCII coded character. Select the parity type according to host device requirements.

- Select None when no parity bit is required.
- Select Odd parity and the parity bit value is set to 0 or 1, based on data, to ensure that an odd number of 1 bits are contained in the coded character.
- Select Even parity and the parity bit value is set to 0 or 1, based on data, to ensure that an even number of 1 bits are contained in the coded character.

Handshaking Control

The data interface consists of an RS-232 port designed to operate either with or without the hardware handshaking lines, Request to Send (RTS), and Clear to Send (CTS). Handshaking Control includes the following options:

- RTS — RTS is asserted during transmissions. CTS is ignored.
- RTS/CTS — RTS is asserted during transmissions. CTS gates transmissions.
- RTS/XON/XOFF — RTS is asserted during transmissions. CTS is ignored. XON and XOFF gate transmissions.
- RTS On/CTS — RTS is always asserted. CTS gates transmissions.
- RTS/CTS Scan Control — RTS is asserted during transmissions. CTS gates transmissions and controls enable and disable state of reader.

RS-232/USB COM PARAMETERS

Intercharacter Delay

This parameter specifies the intercharacter delay between the end of one character and the beginning of the next. The delay can be set within a range of zero (0) to 990 milliseconds in 10ms increments. A setting of zero specifies no delay.

To set the delay:

1. Determine the desired setting in milliseconds.
2. Divide the desired setting by 10 (setting is in 10ms increments). Pad the result with leading zeroes to yield two digits. For example: 0 = 00, 5 = 05, 20 = 20, etc.
3. Scan the ENTER/EXIT PROGRAMMING MODE bar code to enter Programming Mode.
4. Go to [page 36](#) and scan the bar code: SELECT INTERCHARACTER DELAY SETTING.
5. Scan the appropriate two digits from the keypad in [Appendix D](#), that represent the duration which was determined in the steps above. You will hear a two-beep indication after the last character.



NOTE: If you make a mistake before the last character, scan the CANCEL bar code to abort and not save the entry string. You can then start again at the beginning.

6. Scan the ENTER/EXIT PROGRAMMING MODE bar code to exit.

This completes the procedure. See the following table for examples of how to set this feature.

Table 6 - Intercharacter Delay Setting Examples

STEP	ACTION	EXAMPLES			
1	Desired Setting	50ms	150ms	600ms	850ms
2	Divide by 10 (pad with leading zeroes to yield two-digits)	05	15	60	85
3	Scan ENTER/EXIT PROGRAMMING MODE				
4	Scan SELECT INTERCHARACTER DELAY SETTING				
5	Scan two characters from Appendix D	'0' and '5'	'1' and '5'	'6' and '0'	'8' and '5'
6	Scan ENTER/EXIT PROGRAMMING MODE				

ACK NAK Options

This enables/disables the ability of the reader to support the RS-232 ACK/NAK protocol. When configured, the reader and/or host sends an “ACK” when it receives data properly, and sends “NAK” when the data is in error.

Options are:

- Disable
- Enable for label transmission — The reader expects an ACK/NAK response from the host when a label is sent
- Enable for host-command acknowledge — The reader will respond with ACK/NAK when the host sends a command
- Enable for label transmission and host-command acknowledge

ACK Character

This setting specifies an ASCII character or hex value to be used as the ACK character. ASCII characters or any hex value from 0 to 0xFF can be selected.



NOTE: Setting to previously defined characters such as XON, XOFF, or host commands conflicts with normal operation of these characters. 8-bit data is not recognized when the option Data Bits page 39 has been set as 7 Data Bits.

1. Determine the desired character or value.
2. Use the ASCII Chart on [page 340](#) to find the hex equivalent for the desired character/value.
3. Scan ENTER/EXIT PROGRAMMING MODE to enter Programming Mode.
4. Scan the bar code: SELECT ACK CHARACTER SETTING.
5. Scan the appropriate two alphanumeric characters from the keypad in [Appendix D](#), that represent the desired character/value determined above. The second character will cause a two-beep indication.
6. Scan the ENTER/EXIT PROGRAMMING MODE bar code to exit.

See the table below for examples of how to set this feature.

Table 7 - ACK Character Setting Examples

STEP	ACTION	EXAMPLES			
1	Desired Character/Value	ACK	\$	@	>
2	Hex equivalent from ASCII Chart on page 340	0x06	0x24	0x40	0x3E
3	Scan ENTER/EXIT PROGRAMMING MODE				
4	Scan SELECT ACK CHARACTER SETTING				
5	Scan two characters from Appendix D	'0' and '6'	'2' and '4'	'4' and '0'	'3' and 'E'
6	Scan ENTER/EXIT PROGRAMMING MODE				

NAK Character

This setting specifies an ASCII character or hex value to be used as the NAK character. ASCII characters or any hex value from 0 to 0xFF can be selected.



NOTE: Setting to previously defined characters such as XON, XOFF, or host commands conflicts with normal operation of these characters. 8-bit data is not recognized when the option Data Bits on page 39 has been set as 7 Data Bits.

To set this feature:

1. Determine the desired character or value.
2. Use the ASCII Chart on [page 340](#) to find the hex equivalent for the desired character/value.
3. Scan the ENTER/EXIT PROGRAMMING MODE bar code to enter Programming Mode.
4. Scan the bar code: SELECT NAK CHARACTER SETTING.
5. Scan the appropriate two alpha-numeric characters from the keypad in [Appendix D](#), that represent the desired character/value determined above. The second character will cause a two-beep indication.
6. Scan the ENTER/EXIT PROGRAMMING MODE bar code to exit Programming Mode.

This completes the procedure. See the table below for examples of how to set this feature.

Table 8 - NAK Character Setting Examples

STEP	ACTION	EXAMPLES			
1	Desired Character/Value	NAK	\$	@	>
2	Hex equivalent	0x15	0x24	0x40	0x3E
3	Scan ENTER/EXIT PROGRAMMING MODE				
4	Scan SELECT NAK CHARACTER SETTING				
5	Scan two characters from Appendix D	'1' and '5'	'2' and '4'	'4' and '0'	'3' and 'E'
6	Scan ENTER/EXIT PROGRAMMING MODE				

ACK NAK Timeout Value

This option specifies the amount of time the reader waits for an ACK character from the host following label transmission. The selectable timeout range is 200 milliseconds to 15,000ms (15 seconds) in 200ms increments. A selection of 0 disables the timeout.

To set this value:

1. Determine the desired setting in milliseconds.
2. Divide the desired setting by 200 (setting is in 200ms increments). Pad the result with leading zeroes to yield two digits. For example: 0 = 00, 5 = 05, 20 = 20, etc.
3. Scan the ENTER/EXIT PROGRAMMING MODE bar code to enter Programming Mode.
4. Scan the bar code: SELECT ACK NAK TIMEOUT VALUE SETTING.
5. Scan the appropriate two digits from the keypad in [Appendix D](#), that represent the duration which was determined in the steps above. You will hear a two-beep indication after the last character.



NOTE: If you make a mistake before the last character, scan the CANCEL bar code to abort and not save the entry string. You can then start again at the beginning.

6. Scan the ENTER/EXIT PROGRAMMING MODE bar code to exit Programming Mode.

This completes the procedure. See the table below for examples of how to set this feature.

Table 9 - ACK NAK Timeout Value Setting Examples

STEP	ACTION	EXAMPLES			
1	Desired Setting	200ms	1,000ms (1 sec.)	5200ms (5.2 sec.)	15,000ms (15 sec.)
2	Divide by 200	01	05	26	75
3	Scan ENTER/EXIT PROGRAMMING MODE				
4	Scan SELECT ACK NAK TIMEOUT VALUE SETTING				
5	Scan two characters from Appendix D	'0' and '1'	'0' and '5'	'2' and '6'	'7' and '5'
6	Scan ENTER/EXIT PROGRAMMING MODE				

ACK NAK Retry Count

This feature specifies the number of times the reader retries a label transmission due to a retry condition. The selectable range is from 1 to 254 retries. A selection of 0 disables the count, and a selection of 255 specifies unlimited retries.

To set this feature:

1. Determine the desired setting.
2. Pad the number with leading zeroes to yield three digits. For example: 0 = 000, 5 = 005, 20 = 020, etc.
3. Scan the ENTER/EXIT PROGRAMMING MODE bar code to enter Programming Mode.
4. Scan the bar code: SELECT ACK NAK RETRY COUNT SETTING.
5. Scan the appropriate three digits from the keypad in [Appendix D](#), that represent the number which was determined in the steps above. You will hear a two-beep indication after the last character.



NOTE: If you make a mistake before the last character, scan the CANCEL bar code to abort and not save the entry string. You can then start again at the beginning.

6. Scan the ENTER/EXIT PROGRAMMING MODE bar code to exit Programming Mode.

This completes the procedure. See the table below for examples of how to set this feature.

Table 10 - ACK NAK Retry Count Setting Examples

STEP	ACTION	EXAMPLES			
1	Desired Setting	Disable Retry Count	3 Retries	54 Retries	Unlimited Retries
2	Pad with leading zero(es)	000	003	054	255
3	Scan ENTER/EXIT PROGRAMMING MODE				
4	Scan SELECT ACK NAK RETRY COUNT SETTING				
5	Scan three characters from Appendix D	'0', '0' and '0'	'0', '0' and '3'	'0', '5' and '4'	'2', '5' and '5'
6	Scan ENTER/EXIT PROGRAMMING MODE				

Disable Character

Specifies the value of the RS-232 host command used to disable the reader.

ASCII characters or any hex value from 0 to 0xFF can be selected.



NOTE: Setting to previously defined characters such as XON, XOFF, or host commands conflicts with normal operation of these characters. 8-bit data is not recognized when the option "Data Bits" on page 32 has been set as 7 Data Bits.

To set the value:

1. Determine the desired character or value. A setting of 0xFF indicates the Disable Character is not used (not available).
2. Use the ASCII Chart on [page 340](#) to find the hex equivalent for the desired character/value.
3. Scan the ENTER/EXIT PROGRAMMING MODE bar code to enter Programming Mode.
4. Scan the bar code: SELECT DISABLE CHARACTER SETTING on [page 42](#).
5. Scan the appropriate two alphanumeric characters from the keypad in [Appendix D](#), that represent the desired character/value determined above. The second character will cause a two-beep indication.
6. Scan the ENTER/EXIT PROGRAMMING MODE bar code to exit Programming Mode.

This completes the procedure. See the table below for examples of how to set this feature.

Table 11 -Disable Character Setting Examples

STEP	ACTION	EXAMPLES			
1	Desired character/value	'd'	'}'	'D'	Disable Command Not Used
2	Hex equivalent from ASCII Chart on page 340	0x64	0x7D	0x44	0xFF
3	Scan ENTER/EXIT PROGRAMMING MODE				
4	Scan SELECT DISABLE CHARACTER VALUE SETTING				
5	Scan three characters from Appendix D	'6' and '4'	'7' and 'D'	'4' and '4'	'F' and 'F'
6	Scan ENTER/EXIT PROGRAMMING MODE				

Enable Character

Specifies the value of the RS-232 host command used to enable the reader.

ASCII characters or any hex value from 0 to 0xFF can be selected.



NOTE: Setting to previously defined characters such as XON, XOFF, or host commands conflicts with normal operation of these characters. 8-bit data is not recognized when the option "Data Bits" on page 32 has been set as 7 Data Bits.

To set the value:

1. Determine the desired character or value. A setting of 0xFF indicates the Enable Character is not used (not available).
2. Use the ASCII Chart in [Appendix F](#) to find the hex equivalent for the desired character/value.
3. Scan the ENTER/EXIT PROGRAMMING MODE bar code to enter Programming Mode.
4. Scan the bar code: SELECT ENABLE CHARACTER SETTING on [page 42](#).
5. Scan the appropriate two alphanumeric characters from the keypad in [Appendix D](#), that represent the desired character/value determined above. The second character will cause a two-beep indication.
6. Scan the ENTER/EXIT PROGRAMMING MODE bar code to exit Programming Mode.

This completes the procedure. See the table below for examples of how to set this feature.

Table 12 - Enable Character Setting Examples

STEP	ACTION	EXAMPLES			
1	Desired character/value	'e'	'}'	'E'	Enable Command Not Used
2	Hex equivalent from ASCII Chart on page 340	0x65	0x7D	0x45	0xFF
3	Scan ENTER/EXIT PROGRAMMING MODE				
4	Scan SELECT ENABLE CHARACTER VALUE SETTING				
5	Scan two characters from Appendix D	'6' and '5'	'7' and 'D'	'4' and '5'	'F' and 'F'
6	Scan ENTER/EXIT PROGRAMMING MODE				

KEYBOARD INTERFACE (NOT AVAILABLE FOR QW2500/QD2520)

Wedge Quiet Interval

Specifies the amount of time the reader looks for keyboard activity before it breaks the keyboard connection in order to transmit data to host. The range is from 0 to 990ms in 10ms increments.



NOTE: This feature applies ONLY to the Keyboard Wedge interface.

1. Determine the desired setting in milliseconds.
2. Divide the desired setting by 10 (setting is in 10ms increments). Pad the result with leading zeroes to yield two digits. For example: 0 = 00, 5 = 05, 20 = 20, etc.
3. Go to [page 69](#) and scan the ENTER/EXIT PROGRAMMING MODE bar code to enter Prog. Mode.
4. Scan the bar code: SELECT WEDGE QUIET INTERVAL SETTING on [page 69](#).
5. Scan the appropriate two digits from the keypad in [Appendix D](#), that represent the duration which was determined in the steps above. You will hear a two-beep indication after the last character.



NOTE: If you make a mistake before the last character, scan the CANCEL bar code to abort and not save the entry string. You can then start again at the beginning.

6. Scan the ENTER/EXIT PROGRAMMING MODE bar code to exit.

This completes the procedure to set the Wedge Quiet Interval. See the table below for examples of how to set this feature.

Table 13 - Wedge Quiet Interval Setting Examples

STEP	ACTION	EXAMPLES			
1	Desired Setting	10ms	150ms	600ms	850ms
2	Divide by 10 (and pad with leading zeroes)	01	15	60	85
3	Scan ENTER/EXIT PROGRAMMING MODE				
4	Scan SELECT WEDGE QUIET INTERVAL SETTING				
5	Scan two characters from Appendix D	'0' and '1'	'1' and '5'	'6' and '0'	'8' and '5'
6	Scan ENTER/EXIT PROGRAMMING MODE				

Intercharacter Delay

This parameter specifies the intercharacter delay between the end of one character and the beginning of the next. The delay can be set within a range of zero (0) to 990 milliseconds in 10ms increments. A setting of zero specifies no delay.



NOTE: This feature applies ONLY to the Keyboard Wedge interface.

To set the delay:

1. Determine the desired setting in milliseconds.
2. Divide the desired setting by 10 (setting is in 10ms increments). Pad the result with leading zeroes to yield two digits. For example: 0 = 00, 5 = 05, 20 = 20, etc.
3. Go to [page 69](#) and scan the ENTER/EXIT PROGRAMMING MODE bar code to enter Programming Mode.
4. Scan the bar code: SELECT INTERCHARACTER DELAY SETTING on [page 69](#).
5. Scan the appropriate two digits from the keypad in [Appendix D](#), that represent the duration which was determined in the steps above. You will hear a two-beep indication after the last character.



NOTE: If you make a mistake before the last character, scan the CANCEL bar code to abort and not save the entry string. You can then start again at the beginning.

6. Scan the ENTER/EXIT PROGRAMMING MODE bar code to exit Programming Mode. This completes the procedure. See the table below for examples of how to set this feature.

Table 14 - Intercharacter Delay Setting Examples

STEP	ACTION	EXAMPLES			
1	Desired Setting	50ms	150ms	600ms	850ms
2	Divide by 10 (and pad with leading zeroes to yield two-digits)	05	15	60	85
3	Scan ENTER/EXIT PROGRAMMING MODE				
4	Scan SELECT INTERCHARACTER DELAY SETTING				
5	Scan two characters from Appendix D	'0' and '5'	'1' and '5'	'6' and '0'	'8' and '5'
6	Scan ENTER/EXIT PROGRAMMING MODE				

Intercode Delay

Specifies the delay between labels transmitted to the host for this interface. The selectable range for this feature is from 0 to 99 seconds.

Follow these instructions to set this feature:

1. Determine the desired setting.
2. Pad the number with leading zeroes to yield two digits. For example: 0 = 00, 5 = 05, 20 = 20, etc
3. Go to [page 70](#) and scan the ENTER/EXIT PROGRAMMING MODE bar code to enter Programming Mode.
4. Scan the bar code: SELECT INTERCODE DELAY SETTING on [page 70](#).
5. Scan the appropriate two digits from the keypad in [Appendix D](#), that represent the duration which was determined in the steps above. You will hear a two-beep indication after the last character.



NOTE: If you make a mistake before the last character, scan the CANCEL bar code to abort and not save the entry string. You can then start again at the beginning.

6. Scan the ENTER/EXIT PROGRAMMING MODE bar code to exit Programming Mode. This completes the procedure. See the table below for examples of how to set this feature.

Table 15 - Intercode Delay Setting Examples

STEP	ACTION	EXAMPLES			
1	Desired Setting	No Delay	5 seconds	60 seconds	99 seconds
2	Pad with leading zero(es)	00	05	60	99
3	Scan ENTER/EXIT PROGRAMMING MODE				
4	Scan SELECT INTERCODE DELAY SETTING				
5	Scan two characters from Appendix D	'0' and '0'	'0' and '5'	'6' and '0'	'9' and '9'
6	Scan ENTER/EXIT PROGRAMMING MODE				

DATA FORMAT

Data Editing

When a bar code is scanned, additional information can be sent to the host computer along with the bar code data. This combination of bar code data and supplementary user-defined data is called a “message string.” The Data Editing features can be used to build specific user-defined data into a message string.

There are several types of selectable data characters that can be sent before and after scanned data. You can specify if they should be sent with all symbologies, or only with specific symbologies. The following shows the available elements you can add to a message string:

Figure 17 - Breakdown of a Message String

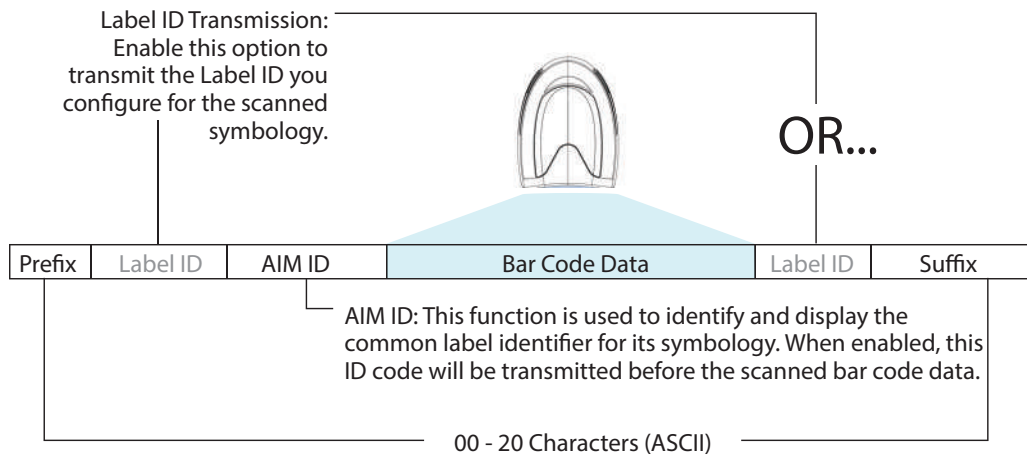

NOTE: Additional advanced editing is available. See the Advanced formatting features in the Datalogic Aladdin configuration software, or contact "Technical Support" on page xiv for more information.

Please Keep In Mind...

- Modifying a message string is not a mandatory requirement. Data editing is a sophisticated feature allowing highly customizable output for advanced users. Factory default settings for data editing is typically set to NONE.
- A prefix or suffix may be applied only to a specified symbology (reference [1D Symbologies, starting on page 111](#)) or across all symbologies (set via the Global features in [Configuration with Bar Codes, starting on page 27](#)).
- You can add any character from the ASCII Chart on [page 340](#) (from 00-FF) on the inside back cover of this manual as a prefix, suffix or Label ID.
- Enter prefixes and suffixes in the order in which you want them to appear on the output.

Global Prefix/Suffix

Up to 20 ASCII characters may be added as a prefix (in a position before the bar code data) and/or as a suffix (in a position following the bar code data) as indicated.

Figure 18 Prefix and Suffix Positions

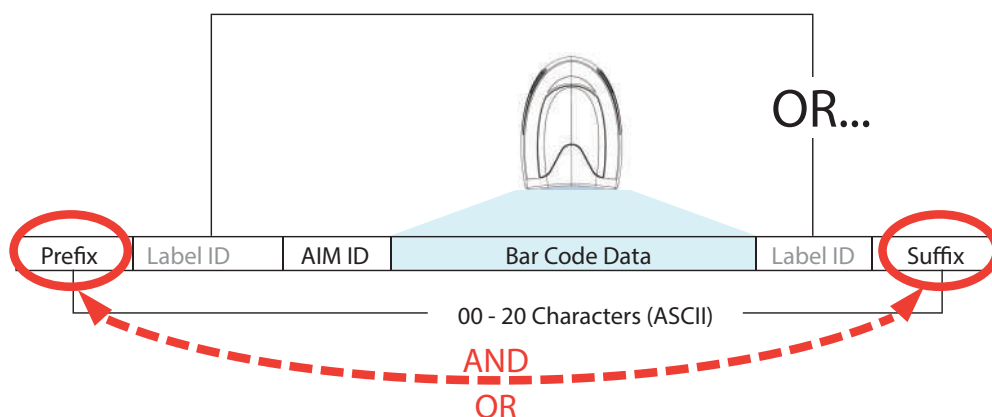

Example: Setting a Prefix

In this example, we'll set a prefix for all symbologies.

1. Determine which ASCII character(s) are to be added to scanned bar code data. In this example, we'll add a dollar sign ('\$') as a prefix.
2. Scan the ENTER/EXIT PROGRAMMING MODE bar code, then scan the SET GLOBAL PREFIX bar code.
3. Reference the ASCII Chart on [page 340](#) in [Appendix F](#) to find the hex value assigned to the desired character. The corresponding hex number for the '\$' character is 24. To enter this selection code, scan the '2' and '4' bar codes from [Appendix D](#).



NOTE: If you make a mistake before the last character, scan the CANCEL bar code to abort and not save the entry string. You can then start again at the beginning.

4. If less than the expected string of 20 characters are selected, scan the ENTER/EXIT bar code to terminate the string.
5. Scan the ENTER/EXIT bar code once again to exit Programming Mode.

The resulting message string would appear as follows:

Scanned bar code data: **12345**

Resulting message string output: **\$12345**

Global AIM ID



NOTE: This feature enables/disables addition of AIM IDs for all symbology types.

AIM label identifiers (as opposed to custom characters you select yourself as with label identifiers) can be included with scanned bar code data. AIM label identifiers consist of three characters as follows:

- A close brace character (ASCII ‘}’), followed by...
- A code character (see the table below), followed by...
- A modifier character (the modifier character is symbol dependent).

SYMBOLGY	CHAR	SYMBOLGY	CHAR
UPC/EAN	E ^a	Code 128/GS1-128	C
Code 39 and Code 32	A	DataBar Omnidirectional, DataBar Expanded	e
Codabar	F	Standard 2 of 5	S
Interleaved 2 of 5	I	ISBN	X ^b
Code 93	G	Code 11	H

- a. UPC-A and UPC-E labels are converted to EAN 13 when adding AIM IDs.
 b. ISBN (X with a 0 modifier character)

Figure 19 AIM ID

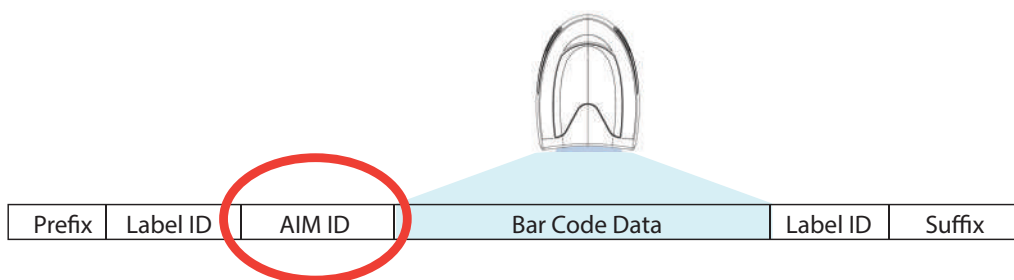

Label ID

A Label ID is a customizable code of up to three ASCII characters (each can be one of hex 0x01-0xFF), used to identify a bar code (symbology) type. It can be appended previous to or following the transmitted bar code data depending upon how this option is enabled. This feature provides options for configuring custom Label IDs as a pre-loaded set or individually per symbology (see "[Label ID: Set Individually Per Symbology](#)" on page 81). If you wish to program the reader to always include an industry standard label identifier for ALL symbology types, see "[Global AIM ID](#)" on page 79.

Label ID: Pre-loaded Sets

The following table lists the pre-loaded label ID sets for the USA and Europe.

Table 16 - Label ID Pre-loaded Sets

SYMBOLGY	USA LABEL ID SET		EU LABEL ID SET	
	ASCII character	Hex value	ASCII character	Hexadecimal value
ABC Codabar	S	530000	S	530000
CODABAR	%	250000	R	520000
Code 39 CIP HR	Y	590000	Y	590000
Code 93	&	260000	U	550000
Code 11	CE	434500	b	620000
Code 128	#	230000	T	540000
Code 32	A	410000	X	580000
Code 39	*	2A0000	V	560000
Datalogic 2of5	s	730000	s	730000
EAN13	F	460000	B	420000
EAN13 P2	F	460000	L	4C0000
EAN13 P5	F	460000	M	4D0000
EAN8	FF	464600	A	410000
EAN8 P2	FF	464600	J	4A0000
EAN8 P5	FF	464600	K	4B0000
FOLLETT 2OF5	O	4F0000	O	4F0000
GS1 DATABAR EXPANDED	RX	525800	t	740000
GS1 DATABAR LIMITED	RL	524C00	v	760000
GS1 DATABAR OMNIDIRECTIONAL	R4	523400	u	750000
GS1-128		000000	k	6B0000
I2OF5	i	690000	N	4E0000
IATA	IA	494100	&	260000
Industrial 2 of 5	W	570000	W	570000
Interleaved 2 of 5	e	650000	e	650000
ISBN	l	490000	@	400000
ISBT128	f	660000	f	660000

SYMBOLGY	USA LABEL ID SET		EU LABEL ID SET	
ISSN	n	6E0000	n	6E0000
MSI	@	400000	Z	5A0000
S25	s	730000	P	500000
UPCA	A	410000	C	430000
UPCA P2	A	410000	F	460000
UPCA P5	A	410000	G	470000
UPCE	E	450000	D	440000
UPCE P2	E	450000	H	480000
UPCE P5	E	450000	I	490000
OCR-A	o	6F0000	\$o	246F00
OCR-B	o	6F0000	\$p	247000
MICR	o	6F0000	\$m	246D00

Label ID: Set Individually Per Symbology

To configure a Label ID individually for a single symbology:

1. Scan the ENTER/EXIT bar code.
2. Select Label ID position as either BEFORE (Enable as Prefix) or AFTER (Enable as suffix) by scanning the appropriate bar code in the section "Label ID Control" on page 81. Reference Figure 20 for Label ID positioning options if multiple identification features are enabled.
3. Scan a bar code to select the symbology for which you wish to configure a custom Label ID from the section "Label ID Symbology Selection" on page 82.
4. Determine the desired character(s) (you may choose up to three) which will represent the Label ID for the selected symbology.
5. Turn to the ASCII Chart on page 340 on the inside back cover of this manual and find the equivalent hex digits associated with your choice of Label ID. For example, if you wish to select an equal sign (=) as a Label ID, the chart indicates its associated hex characters as 3D. Turn to Keypad, in Appendix D, and scan the bar codes representing the hex characters determined. For the example given, the characters '3' and 'D' would be scanned. More examples of Label ID settings are provided in Table 17 on page 278.



NOTE: If you make a mistake before the last character, scan the CANCEL bar code to abort and not save the entry string. You can then start again at the beginning.

6. Scan the ENTER/EXIT bar code to exit Label ID entry.
 7. Scan the ENTER/EXIT bar code once again to exit Programming Mode.
- This completes the steps to configure a Label ID for a given symbology.

Figure 20 Label ID Position Options

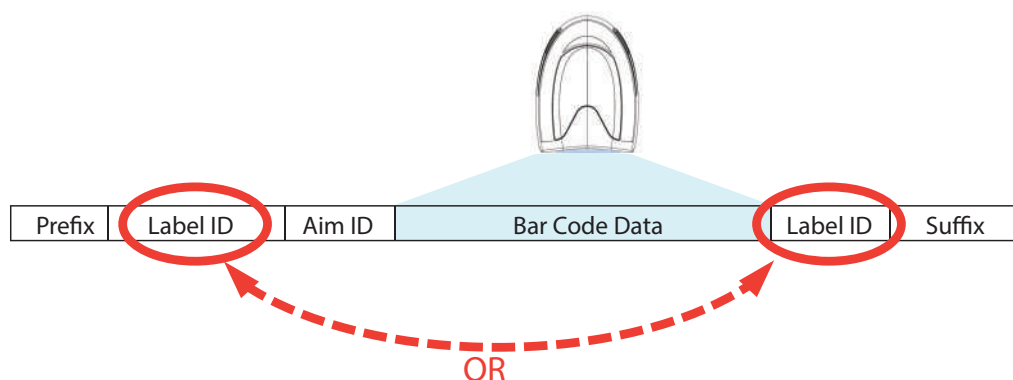

Label ID: Set Individually Per Symbology — continued

Table 17 Label ID Examples

STEP	ACTION	EXAMPLES			
1	Scan the ENTER/EXIT bar code	(Reader enters Programming Mode)			
2	Determine placement of the Label ID characters BEFORE or AFTER with regard to scanned data using Label ID Control, starting on page 81	Enable as Prefix	Enable as Suffix	Enable as Prefix	Enable as Suffix
3	Scan the bar code selecting the symbology type you wish to designate label ID characters for using Label ID Symbology Selection, starting on page 82	GS1 DataBar Omnidirectional	Code 39	Interleaved 2 of 5	Code 32
4	Custom Label ID example (desired characters):	D B *	= C 3	+	PH
5	Find hex equivalents from the ASCII table (inside back cover), then scan in these digits/characters using the bar codes in the section: Keypad, starting on page 327. If you make a mistake before the last character, scan the CANCEL bar code to abort and not save the entry string. You can then start again at the beginning.	44 42 2A	3D 43 33	2B	50 48
6	Scan the ENTER/EXIT bar code	(Reader exits Label ID entry)			
7	Scan the ENTER/EXIT bar code once again	(Reader exits Programming Mode)			
Result:		DB*[bar code data]	[bar code data]=C3	+[bar code data]	[bar code data]PH

Character Conversion

Character conversion is an eight byte configuration item. The eight bytes are 4 character pairs represented in hexadecimal ASCII values. The first character in the pair is the character that will be converted. The second character in the pair is the character to convert to. If the character to convert in a pair is FF, then no conversion is done.

For example, if you have the character conversion configuration item set to the following: 41423132FFFFFFFF

The first pair is 4142 or AB (41 hex is an ASCII capital A, 42 hex is an ASCII capital B) and the second pair is 3132 or 12 (31 hex is an ASCII 1, 32 is an ASCII 2). The other two pairs are FFFF and FFFF.

With the label, AB12BA21, it would look as follows after the character conversion: BB22BB22.

The A characters were converted to B characters and the 1 characters were converted to 2 characters. Nothing is done with the last two character pairs, since they are all FF.

To set Character Conversion:

1. Scan the ENTER/EXIT bar code.
2. Scan the bar code for "Character Conversion" on page 78
3. Determine the desired string. Sixteen positions must be determined as in the above example. Next, turn to the ASCII Chart on page 340 on the inside back cover of this manual and find the equivalent hex digits needed to fulfill the string.
4. Turn to Appendix D, Keypad and scan the bar codes representing the hex characters determined in the previous step.
5. Scan the ENTER/EXIT bar code to exit Programming Mode.



NOTE: If less than the expected string of 16 characters are selected, scan the ENTER/EXIT bar code twice to accept the selections and exit Programming Mode.

SCANNING FEATURES

Scan Mode

Selects the scan operating mode for the reader. Selections are:

Trigger Single: When the trigger is pulled, scanning is activated until one of the following occurs:

- Stand Mode/Object Detection has elapsed
- a label has been read
- the trigger is released

This mode is associated with typical handheld reader operation: when the trigger is pulled, scanning starts and the product scans until the trigger is released, or a label is read, or the maximum Stand Mode/Object Detection has elapsed.

Trigger Hold Multiple: When the trigger is pulled, scanning starts and the product scans until the trigger is released or Stand Mode/Object Detection has elapsed. Reading a label does not disable scanning. [Double Read Timeout](#) prevents undesired multiple reads of the same label while in this mode.

Trigger Pulse Multiple: When the trigger is pulled, continuous scanning is activated until Stand Mode/Object Detection has elapsed or the trigger has been released and pulled again. [Double Read Timeout](#) prevents undesired multiple reads of the same label while in this mode.

Flashing: The reader flashes¹ on and off regardless of the trigger status. Flash rate is controlled by [Flash On Time](#) and [Flash Off Time](#). When Flash is ON the reader reads continuously. When Flash is OFF scanning is deactivated.

Always On: No trigger pull is required to read a bar code. Scanning is continually on. [Double Read Timeout](#) prevents undesired multiple reads of the same label while in this mode.

Stand Mode/Object Detection: No trigger pull is required to read a bar code. Scanning turns on automatically when an item is placed in reader's field of view. While in a stand watch state, the reader illumination LED goes from dim to maximum bright.

Trigger Object Sense: The reader detects changes within its field-of-view and automatically turns on the illuminator. Decoding is not automatic. To decode it is necessary to pull the trigger.

Scanning Active Time

This setting specifies the amount of time that the reader stays in scan ON state once the state is entered. The range for this setting is from 1 to 255 seconds in 1-second increments.

Follow these instructions to set this feature:

1. Determine the desired setting.
2. Pad the result with leading zeroes to yield three digits. For example: 0 = 000, 5 = 005, 20 = 020, etc.

1. Controlled by [Flash On Time](#).

3. Scan the ENTER/EXIT PROGRAMMING MODE bar code to enter Programming Mode.
4. Scan the bar code: SELECT SCANNING ACTIVE TIME SETTING on [page 89](#).
5. Scan the appropriate three digits from the keypad in [Appendix D](#), that represent the duration which was determined in the steps above. You will hear a two-beep indication after the last character.



NOTE: If you make a mistake before the last character, scan the CANCEL bar code to abort and not save the entry string. You can then start again at the beginning.

6. Scan the ENTER/EXIT PROGRAMMING MODE bar code to exit Programming Mode. This completes the procedure. See the table below for examples of how to set this feature.

Table 18 Scanning Active Time Setting Examples

STEP	ACTION	EXAMPLES			
1	Desired Setting	1 Second	90 Sec. (1.5 min.)	180 Sec. (3 min.)	255 Seconds (4.25 min.)
2	Pad leading zero(es)	001	090	180	255
3	Scan ENTER/EXIT PROGRAMMING MODE				
4	Scan SELECT SCANNING ACTIVE TIME SETTING				
5	Scan three characters from Appendix D	'0', '0' and '1'	'0', '9' and '0'	'1', '8' and '0'	'2', '5' and '5'
6	Scan ENTER/EXIT PROGRAMMING MODE				

Aiming Duration Time

Specifies the frame of time the aiming pointer remains on after decoding a label, when in trigger single mode. The range for this setting is from 1 to 255 seconds in 1-second increments.

Follow these instructions to set this feature:

1. Determine the desired setting.
2. Pad the result with leading zeroes to yield three digits. For example: 0 = 000, 5 = 005, 20 = 020, etc.
3. Scan the ENTER/EXIT PROGRAMMING MODE bar code to enter Programming Mode.
4. Scan the bar code: SELECT AIMING DURATION TIME SETTING.
5. Scan the appropriate two digits from the keypad in [Appendix D](#), that represent the duration which was determined in the steps above. You will hear a two-beep indication after the last character.



NOTE: If you make a mistake before the last character, scan the CANCEL bar code to abort and not save the entry string. You can then start again at the beginning.

6. Scan the ENTER/EXIT PROGRAMMING MODE bar code to exit Programming Mode. This completes the procedure. See the following table for some examples of how to set this feature.

Table 19 Aiming Duration Time Setting Examples

STEP	ACTION	EXAMPLES			
1	Desired Setting	1 Second	90 Sec. (1.5 min.)	180 Sec. (3 min.)	255 Seconds (4.25 min.)
2	Pad leading zero(es)	001	090	180	255
3	Scan ENTER/EXIT PROGRAMMING MODE				
4	Scan SELECT AIMING DURATION TIME SETTING				
5	Scan three characters from Appendix D	'0', '0' and '1'	'0', '9' and '0'	'1', '8' and '0'	'2', '5' and '5'
6	Scan ENTER/EXIT PROGRAMMING MODE				

Flash On Time

This feature specifies the ON time for the indicator LED while in Flash Mode. The selectable range is 100 to 9,900 milliseconds (0.1 to 9.9 seconds), in 100 millisecond increments.

Follow these instructions to set this feature.

1. Determine the desired setting in milliseconds.
2. Divide the desired setting by 100 (setting is in 100ms increments). Pad the result with leading zeroes to yield two digits. For example: 0 = 00, 5 = 05, 20 = 20, etc.
3. Scan the ENTER/EXIT PROGRAMMING MODE bar code to enter Programming Mode.
4. Scan the bar code: SELECT FLASH ON TIME SETTING on [page 89](#).
5. Scan the appropriate two digits from the keypad in [Appendix D](#), that represent the duration which was determined in the steps above. You will hear a two-beep indication after the last character.



NOTE: If you make a mistake before the last character, scan the CANCEL bar code to abort and not save the entry string. You can then start again at the beginning.

6. Scan the ENTER/EXIT PROGRAMMING MODE bar code to exit Programming Mode.

This completes the procedure. See the following table for examples of how to set this feature.

Table 20 Flash On Time Setting Examples

STEP	ACTION	EXAMPLES			
1	Desired Setting	500ms	1,000ms (1 sec.)	5200ms (5.2 sec.)	9,900ms (9.9 sec.)
2	Divide by 100 (and pad with leading zeroes to yield two digits)	05	10	52	99
3	Scan ENTER/EXIT PROGRAMMING MODE				
4	Scan SELECT FLASH ON TIME SETTING				
5	Scan two characters from Appendix D	'0' and '5'	'1' and '0'	'5' and '2'	'9' and '9'
6	Scan ENTER/EXIT PROGRAMMING MODE				

Flash Off Time

This feature specifies the OFF time for the indicator LED while in Flash Mode. The selectable range is 100 to 9,900 milliseconds (0.1 to 9.9 seconds), in 100 millisecond increments.

Follow these instructions to set this feature.

1. Determine the desired setting in milliseconds.
2. Divide the desired setting by 100 (setting is in 100ms increments). Pad the result with leading zeroes to yield two digits. For example: 0 = 00, 5 = 05, 20 = 20, etc.
3. Scan the ENTER/EXIT PROGRAMMING MODE bar code to enter Programming Mode.
4. Scan the bar code: SELECT FLASH OFF TIME SETTING on [page 90](#).
5. Scan the appropriate two digits from the keypad in [Appendix D](#), that represent the duration which was determined in the steps above. You will hear a two-beep indication after the last character.



NOTE: If you make a mistake before the last character, scan the CANCEL bar code to abort and not save the entry string. You can then start again at the beginning.

6. Scan the ENTER/EXIT PROGRAMMING MODE bar code to exit Programming Mode. This completes the procedure. See the following table for examples of how to set this feature.

Table 21 Flash Off Time Setting Examples

STEP	ACTION	EXAMPLES			
1	Desired Setting	500ms	1,000ms (1 sec.)	5200ms (5.2 sec.)	9,900ms (9.9 sec.)
2	Divide by 100 (and pad with leading zeroes to yield two digits)	05	10	52	99
3	Scan ENTER/EXIT PROGRAMMING MODE				
4	Scan SELECT FLASH OFF TIME SETTING				
5	Scan two characters from Appendix D	'0' and '5'	'1' and '0'	'5' and '2'	'9' and '9'
6	Scan ENTER/EXIT PROGRAMMING MODE				

LED AND BEEPER INDICATORS

Good Read LED Duration

This feature specifies the amount of time that the Good Read LED remains on following a good read. The good read LED on time can be set within a range of 10 milliseconds to 2,550 milliseconds (0.001 to 2.55 seconds) in 100ms increments.

Follow these instructions to set this feature:

1. Determine the desired setting in milliseconds. A setting of 0 means that the good read LED stays on until the next time the trigger is pulled.
2. Divide the desired setting by 10 (setting is in 100ms increments). Pad the result with leading zeroes to yield three digits. For example: 0 = 000, 5 = 000, 20 = 020, etc.
3. Go to [page 101](#) and scan the ENTER/EXIT PROGRAMMING MODE bar code to enter Programming Mode.
4. Scan the bar code: SELECT GOOD READ LED DURATION SETTING.
5. Scan the appropriate two digits from the keypad in [Appendix D](#), that represent the duration which was determined in the steps above. You will hear a two-beep indication after the last character.



NOTE: If you make a mistake before the last character, scan the CANCEL bar code to abort and not save the entry string. You can then start again at the beginning.

6. Scan the ENTER/EXIT PROGRAMMING MODE bar code to exit Programming Mode. This completes the procedure. See the following table for some examples of how to set this feature.

Table 22 Good Read LED Duration Setting Example

STEP	ACTION	EXAMPLES			
1	Desired Setting	Good Read LED stays on until next trigger pull (00)	20ms	150ms	2550ms (2.55 sec.)
2	Divide by 10 (and pad with leading zeroes)	000	002	015	255
3	Scan ENTER/EXIT PROGRAMMING MODE				
4	Scan SELECT GOOD READ LED DURATION SETTING				
5	Scan three characters from Appendix D	'0', '0' and '0'	'0', '0' and '2'	'0', '1' and '5'	'2', '5' and '5'
6	Scan ENTER/EXIT PROGRAMMING MODE				

RF FEATURES

Automatic Configuration Update

When this feature is enabled, the base station and reader will keep their configurations synchronized. If a reader's configuration is altered by reading programming labels, this change is automatically transferred and updated in a linked base station. Likewise, if the base station's configuration is changed using Aladdin or by host commands, then the reader's configuration will automatically be updated if this feature is enabled.

RF Address Stamping

Source Radio Address Delimiter Character

This option specifies the delimiter character to be placed between the label data and radio address when address stamping is enabled.



NOTE: This feature only applies if "Source Radio Address Transmission" on page 244 is enabled

Follow these instructions to select the delimiter character:

1. Determine the desired character, then find its hexadecimal equivalent on the ASCII Chart on [page 340](#). A setting of 00 specifies no delimiter character.
2. Scan the ENTER/EXIT PROGRAMMING MODE bar code to enter Programming Mode.
3. Scan the bar code: SET SOURCE RADIO ADDRESS DELIMITER CHARACTER.
4. Scan the appropriate two digits from the keypad in [Appendix D](#), that represent the hexadecimal characters which were determined in the steps above. You will hear a two-beep indication after the last character.



NOTE: If you make a mistake before the last character, scan the CANCEL bar code to abort and not save the entry string. You can then start again at the beginning.

5. Scan the ENTER/EXIT PROGRAMMING MODE bar code to exit.

Table 23 Source Radio Address Delimiter Character Setting Examples

STEP	ACTION	EXAMPLES			
1	Desired Setting	No delimiter character	, (comma)	- (dash)	/ (slash)
2	Scan ENTER/EXIT PROGRAMMING MODE				
3	Scan SET SOURCE RADIO ADDRESS DELIMITER CHARACTER				
4	Scan Two Characters From Appendix D	'0' and '0'	'2' and 'C'	'2' and 'D'	'2' and 'F'
5	Scan ENTER/EXIT PROGRAMMING MODE				

STAR Radio Protocol Timeout

This parameter sets the valid wait time before transmission between the handheld reader and Base Station is considered failed.

When setting this parameter, take into consideration the radio traffic (number of readers in the same area). The selectable range for this feature is from 02 to 25 seconds.

Follow these instructions to set this feature:

1. Determine the desired setting.
2. Pad the number with leading zeroes to yield two digits. For example: 2 = 02, 5 = 05, 25 = 25, etc
3. Scan the ENTER/EXIT PROGRAMMING MODE barcode to enter Programming Mode.
4. Scan the barcode: SELECT RADIO PROTOCOL TIMEOUT.
5. Scan the appropriate two digits from the keypad in [Appendix D](#), that represent the duration which was determined in the steps above. You will hear a two-beep indication after the last character.



NOTE: If you make a mistake before the last character, scan the CANCEL bar code to abort and not save the entry string. You can then start again at the beginning.

6. Scan the ENTER/EXIT PROGRAMMING MODE barcode to exit Programming Mode.

This completes the procedure. See following table for some examples of how to set this feature.

Table 24 STAR Radio Protocol Timeout Examples

STEP	ACTION	EXAMPLES			
1	Desired Setting	2 Seconds	5 Seconds	10 Seconds	25 Seconds
2	Pad with leading zero(es)	02	05	10	25
3	Scan ENTER/EXIT PROGRAMMING MODE				
4	Scan SELECTSTAR RADIO PROTOCOL TIMEOUT SETTING				
5	Scan two characters from Appendix D	'0' and '2'	'0' and '5'	'1' and '0'	'2' and '5'
5	Scan ENTER/EXIT PROGRAMMING MODE				

SYBLOGIES

Set Length

Length Control allows you to select either variable length decoding or fixed length decoding for the specified symbology.

Variable Length: For variable length decoding, a minimum and maximum length may be set.

Fixed Length: For fixed length decoding, two different lengths may be set.

Set Length 1

This feature specifies one of the bar code lengths for a given symbology. Length 1 is the minimum label length if in Variable Length Mode, or the first fixed length if in Fixed Length Mode.

Reference the [1D Symbologies, starting on page 111](#) to view the selectable range (number of characters) for the symbology being set.

Follow these instructions to set this feature:

1. Determine the desired character length. Pad the number with leading zeroes to yield two digits. For example: 0 = 00, 5 = 05, 20 = 20, etc.
2. Scan the ENTER/EXIT PROGRAMMING MODE bar code to enter Programming Mode.
3. Scan the "Select Length 1 Setting" for the symbology being set.
4. Scan the appropriate two digits from the keypad in [Appendix D](#), that represent the length setting which was determined in the steps above. You will hear a two-beep indication after the last character.



NOTE: If you make a mistake before the last character, scan the CANCEL bar code to abort and not save the entry string. You can then start again at the beginning.

5. Scan the ENTER/EXIT PROGRAMMING MODE bar code to exit Programming Mode. This completes the procedure. See the following table for examples of how to set this feature.

Table 25 Length 1 Setting Examples

STEP	ACTION	EXAMPLES			
1	Desired Setting	01 Character	07 Character	52 Character	74 Character
2	Scan ENTER/EXIT PROGRAMMING MODE				
3	Scan SELECT LENGTH 1 SETTING for the desired symbology				
4	Scan two characters from Appendix D	'0' and '1'	'0' and '7'	'5' and '2'	'7' and '4'
5	Scan ENTER/EXIT PROGRAMMING MODE				

Set Length 2

This feature specifies one of the bar code lengths for a given symbology. Length 2 is the maximum label length if in Variable Length Mode, or the second fixed length if in Fixed Length Mode.

Reference the [1D Symbologies, starting on page 111](#) to view the selectable range (number of characters) for the symbology being set. A setting of 00 specifies to ignore this length (only one fixed length).

Follow these instructions to set this feature:

1. Determine the desired character length. Pad the number with leading zeroes to yield two digits. For example: 0 = 00, 5 = 05, 20 = 20, etc.
2. Scan the ENTER/EXIT PROGRAMMING MODE bar code to enter Programming Mode.
3. Scan the "Select Length 2 Setting" for the symbology being set.
4. Scan the appropriate two digits from the keypad in [Appendix D](#), that represent the length setting which was determined in the steps above. You will hear a two-beep indication after the last character.



NOTE: If you make a mistake before the last character, scan the CANCEL bar code to abort and not save the entry string. You can then start again at the beginning.

5. Scan the ENTER/EXIT PROGRAMMING MODE bar code to exit Programming Mode. This completes the procedure. See the following table for examples of how to set this feature.

Table 26 Length 2 Setting Examples

STEP	ACTION	EXAMPLES			
1	Desired Setting	00 (ignore second length)	07 Character	52 Character	74 Character
2	Scan ENTER/EXIT PROGRAMMING MODE				
3	Scan SELECT LENGTH 2 SETTING				
4	Scan two characters from Appendix D	'0' and '0'	'0' and '7'	'5' and '2'	'7' and '4'
5	Scan ENTER/EXIT PROGRAMMING MODE				

CHAPTER 5

MESSAGE FORMATTING

MESSAGE FORMATTING



NOTE: Message Formatting is available for QM2500 models only.

A message from the Host to the base must follow these rules:

- If Address stamping options or address delimiter are enabled on the base, the Host replay must have address field and delimiter too. Otherwise the message will be ignored. Address delimiter is present only when address stamping is enabled.
- Address stamping is necessary to correctly route the message to the QuickScan™, especially when more than one handheld is linked to the same base. Address stamping could be disabled if the system is in point to point configuration. If address stamping is not enabled, the messages are addressed to the first handheld linked to the base.
- The maximum character length for messages is 48.
- Messages end with “CR” 0x0D ASCII character. The CR character cannot be contained in the middle.
- Messages cannot start with '\$' or # because these are reserved for Service mode command
- Base station can receive host message only if Host Commands Obey/Ignore is set to Ignore.
- Message could be sent to the HH in response to a Label when “Transmit mode” require Ack from Host (see transmit mode parameter) or at any time. When messages are sent not in response to a label must start with DC2 0x12 ASCII character and could be sent in any transmit mode setting.
- Message could be sent to all HH linked to base by using a Multicast message: “00 00 00 00 2A AA”
- In order to receive a message, handhelds must not be in sleep state.
- If you want to control the reader's beeper from the host, you will also probably want to disable the good transmission beep that is emitted when the code is received from the base station. (See "[Wireless Features](#)" on page 234).
- The message field can store plain text and escape sequences. Escape sequences are interpreted as commands.

The format of the ACK from Host message (used for transmission mode 02) is:

[Scanner_Addr] [Scanner_Addr_delimiter] MESSAGE <CR>

The format of a generic message From Host to HH is:

[Scanner_Addr] [Scanner_Addr_delimiter] DC2 MESSAGE <CR>

where DC2 is ASCII 0x12 (^R) character.

[Items in square brackets are optional.]

LED AND BEEPER CONTROL

The LED control escape sequences are intended to activate the LEDs for short periods of time and can be used in combination with the Beeper. The LED and Beeper will be controlled by the system after the entire command sequence is interpreted.

ESC SEQUENCE	ACTION
Esc [0 q	Emit short High tone + short delay
Esc [1 q	Emit short Low tone + short delay
Esc [2 q	Emit long Low tone + short delay
Esc [3 q	Emit good read tone
Esc [4 q	Emit bad tx tone
Esc [5 q	Wait 100 msec
Esc [6 q	Turn on the green LED
Esc [7 q	Turn off the green LED
Esc [8 q	Turn on the green spot
Esc [9 q	Turn off the green spot
Esc [0 r	Beep for Find me function (new)
Esc [1 r	Power-off (new)

Example:

Esc [6 q Esc [3 q Esc [7 q	Turns on the green LED, emits a good read tone, and turns off the green LED.
Esc [6 q Esc [5 q Esc [7 q	Turns on the green LED for 100 msec and then turns off the green LED.

Escape sequences different from those listed will be ignored.

APPENDIX A

TECHNICAL SPECIFICATIONS

The table below contains Physical and Performance Characteristics, User Environment and Regulatory information. Table 35 provides Standard Cable Pinouts.

QUICKSCAN™ 2500 TECHNICAL SPECIFICATIONS

Table 27 QD/QW2500 Technical Specifications

ELECTRICAL CHARACTERISTICS	
Power Supply	5 VDC +/- 5%
Consumption	Operating (Typical): <400mA@5V Standby/Idle (Typical): <90mA@5V
Max. Scan Rate	60 frames/sec
Reading Indicators	Top illumination, Good Read Spot, Beep
OPTICAL CHARACTERISTICS	
Optical Format	QuickScan™ QD2500: 1/4" QuickScan™ QW2500: 1/6"
Active Imager Size	QuickScan™ QD2500: 3896 um (H) x 2453 um (V) QuickScan™ QW2500: 2396 um (H) x 1797 um (V)
Active Pixels	QuickScan™ QD2500: 1280 H x 800 V QuickScan™ QW2500: 640 H x 480 V
Illumination System	LED source Red Emission (Wavelength - 617 nm)
Aiming System	LED source Blue Emission (Wavelength - 468 nm)
Ambient Light Up to	0 - 110,000 lux
Tilt Tolerance ^a	0° - 360°
Pitch Tolerance ^a	+/- 65°
Skew Tolerance ^a	+/- 65°
Field of View ^a	QuickScan™ QD2500: 35° H x 22° V QuickScan™ QW2500: 33° H x 25° V
PCS (Datalogic Test Chart)	QuickScan™ QD2500: minimum 15% QuickScan™ QW2500: minimum 20% (15% with specific configuration)

ENVIRONMENTAL CHARACTERISTICS	
Temperature	Operating: 0 to 50 °C / 32 to 122 °F Storage/Transport: -40 to 70 °C / -40 to 158 °F
Storage Temperature	-40 °C to + 70 °C (-40 ° F to +158 °F)
Humidity	95% non condensing
Drop Resistance	Withstands repeated drops from 1.5 m / 5.0 ft onto a concrete surface.
Trigger Resistance	Withstands 10 Mhits
ESD Protection	16 KV
Protection Class	IP52
Cable Length	Refer to www.datalogic.com
PHYSICAL CHARACTERISTICS	
Color	Black White ^b
Dimensions	Height 14.8 cm (5.8") Length 12.6 cm (4.96") Width 6.8 cm (2.7")
Weight (without cable)	145.0 g / 5.1 oz

- a. Based on ISO 15423 specifications
b. Only for QuickScan™ QD2500

Table 28 QBT/QM2500 Technical Specifications

ELECTRICAL CHARACTERISTICS	
Power Supply	Gun TypeC Port: 5V +/- 5% Cradle Port: 4.5V to 14V
Consumption (Typical)	Cradle Only: 45mA @5V (Operating) Cradle with gun during recharge: 500mA (5V USB Host Power Supply) 1100mA (5V Type-C Host Power Supply) 500mA (12V External Power Supply) Gun charging through Type-C port: 500mA (USB Type-A Host port, no Scan) 1040mA (Wall Adapter, no Scan) 1040mA (USB Type-C Host port, no Scan)
Reading Indicators	Top illumination, Good Read Spot, Beep
Max. Scan Rate	60 frames/sec
Battery Capacity	Li-Ion 3.6V, 3250mAh (11.7 W/h)
Recharge Time (Typical)	Gun Only: - USB Type-A Host to Type-C connector: 5h 30m - USB Wall Adapter to Type-C connector: 3h - USB Type-C Host to Type-C connector: 3h Gun on Cradle: - USB Type-A Host: 8h - External 12V Power Supply: 4h - USB Type-C Host: 4h
OPTICAL CHARACTERISTICS	
Optical Format	1/4"
Active Imager Size	3896 um (H) x 2453 um (V)
Active Pixels	1280 H x 800 V
Illumination System	LED source Red Emission (wavelength - 617 nm)
Aiming System	LED source Blue Emission (wavelength - 468nm)
Ambient Light Up to	0 - 110,000 lux
Tilt Tolerance^a	0° - 360°
Pitch Tolerance^a	+/- 65°

a. Based on ISO 15423 specifications

OPTICAL CHARACTERISTICS	
Skew Tolerance ^a	+/- 65°
Field of View ^a	35° x 22°
PCS (Datalogic Test Chart)	minimum 15%
ENVIRONMENTAL CHARACTERISTICS	
Operating Temperature	0 °C to + 50 °C / +32° F to +122 °F
Storage Temperature	-40 °C to + 70 °C / -40 ° F to +158 °F
Humidity	0 - 95% non condensing
Drop Resistance	IEC 68-2-32 Tested 1,5 m / 4,9 ft)
ESD Protection	16 KV
Protection Class	IP52
Cable Length	Refer to www.datalogic.com
PHYSICAL CHARACTERISTICS	
Color	Black, White
Dimensions	Gun only (lhp): 68 x 159 x 107mm / 6.25" x 4.2" x "2.7" Cradle only (lhp): 84 x 83 x 119mm / 4.7" x 3.3" x 3.3" Gun on Cradle (lhp): 84 x 170 x 144mm / 6.7" x 5.7" x 3.3"
Weight	Scanner: 206.5 g / 7.3 oz (battery included) Battery Pack is approx. 71g / 2.50 oz BC2090 is approx. 148.5g / 5.2 oz

a. Based on ISO 15423 specifications

RADIO CHARACTERISTICS			
Wireless Technology	Star™ 910 MHz	Star™ 433 MHz	Bluetooth
Range (Line of Sight)	30 m	30 m	50 m
Max number of devices per base station	1		1

COMMON READING CHARACTERISTICS

Table 29 Reading Characteristics QuickScan™ QD/QBT/QM2500

QUICKSCAN™ QD2500 DOF - DEPTH OF FIELD (TYPICAL) ^A	
Symbology	DOF range
Code 39	5 mil: 0.5 to 25.0 cm / 0.2 to 9.8 in 10 mil: 0.5 to 38.0 cm / 0.2 to 14.9 in
EAN/UPCA	13 mils: 0.5 to 51.0 cm / 0.2 to 20.1 in
PDF417	6.7 mils: 0.5 to 21.0 cm / 0.2 to 8.3 in
Datamatrix	10 mils: 0.5 to 21.5 cm / 0.2 to 8.5 in
Code 128	5 mil: 2 - 21.5 cm / 0.8" - 8.5"
QR Code	20 mils: 0 to 37.0 cm / 0 to 14.6 in
Max Resolution	1D Linear: 0.077 mm / 3 mils; PDF417: 0.077 mm / 3 mils; Data Matrix: 0.127 mm / 5 mils; QR Code: 0.17 mm / 6.7 mils

a. All labels grade A, typical environmental light, 20°C, label inclination 10°

Table 30 - Reading Characteristics QuickScan™ QW2500

QUICKSCAN™ QW2500 DOF - DEPTH OF FIELD (TYPICAL) ^A	
Symbology	DOF range
Code 39	5 mil: 0.5 to 23.0 cm / 0.2 to 9.0 in 10 mil: 0.5 to 37.0 cm / 0.2 to 14.5 in
EAN13/UPCA	13 mils: 1.0 to 40.0 cm / 0.39 to 15.7 in
PDF417	6.7 mils: 0.5 to 13.5 cm / 0.2 to 5.3 in
Datamatrix	10 mils: 1.0 to 15.5 cm / 0.39 to 6.1 in
QR Code	20 mils: 1.0 to 33.0 cm / 0.39 to 12.9 in
Max Resolution	1D Linear: 0.077 mm / 3 mils; PDF417: 0.127 mm / 5 mils; Data Matrix: 0.152 mm / 6 mils; QR Code: 0.17 mm / 6.7 mils

a. All labels grade A, typical environmental light, 20°C, label inclination 10°

DECODING CAPABILITIES

DECODE CAPABILITY
<p>1D Bar Codes</p> <p>UPC/EAN/JAN (A, E, 13, 8); UPC/EAN/JAN (including P2 /P5); UPC/EAN/JAN (including; ISBN / Bookland & ISSN); UPC/EAN Coupons;</p> <p>Code 39 (including full ASCII); Code 39 Trioptic; Code39 CIP HR (French Pharmaceutical); LOGMARS (Code 39 w/ standard check digit enabled); Danish PPT; Code 32 (Italian Pharmacode 39);</p> <p>Code 128; Code 128 ISBT;</p> <p>Interleaved 2 of 5; Standard 2 of 5; Interleaved 2 of 5 CIP (HR); Interleaved 2 of 5 Febraban (for desk models only); Industrial 2 of 5; Discrete 2 of 5; Datalogic 2 of 5 (China Post Code/ Chinese 2 of 5); IATA 2 of 5 Air cargo code; Follet 2 of 5;</p> <p>Codabar; Codabar (NW7); ABC Codabar;</p> <p>Code 11; Code 93; MSI; PZN; Plessey; Anker Plessey;</p> <p>GS1 DataBar Limited; GS1 DataBar Expanded; GS1 DataBar Truncated; DATABAR Expanded Coupon.</p>
<p>2D Stacked Codes</p> <p>The QuickScan™ 2500 family is capable of decoding the following symbologies using multiple frames (i.e. Multi-Frame Decoding):</p> <p>Datamatrix; Inverse Datamatrix; Datamatrix is configurable for the following parameters:; Normal or Inverted; Square or Rectangular Style; Data length (1 - 3600 characters); Maxicode; QR Codes (QR, Micro QR and Multiple QR Codes); Aztec;</p> <p>Postal Codes - (Australian Post; Japanese Post; KIX Post; Planet Code; Postnet; Royal Mail Code (RM45CC); Intelligent Mail Barcode (IMB); Sweden Post; Portugal Post); LaPoste A/R 39; PDF-417; MacroPDF; Micro PDF417; GS1 Composites (1 - 12); French CIP13^a; GS1 DataBar Stacked; GS1 DataBar Stacked Omnidirectional; GS1 DataBar Expanded Stacked; GS1 Databar Composites; GS1 DotCode;</p> <p>Chinese Sensible Code; Inverted 2D codes^b.</p>

- a. It is acceptable to handle this with ULE.
- b. The SW can apply the Normal/Reverse Decoding Control to the following symbologies: Datamatrix, QR, Micro QR, Aztec and Chinese Sensible Code.

LED AND BEEPER INDICATIONS

The reader's beeper sounds and its illumination flashes or changes color to indicate various functions or errors on the reader. A "Green Spot" also lights to indicate a good read. The tables below list these indications.

Table 31 LED and Beeper Indications

INDICATION	LED	BEEPER
Power-up	Upper LED flashes/blinks on power-up. With a USB interface, the LED blinks until enumeration with the host is completed.	Reader beeps four times at highest frequency and volume upon power-up.
Good Read	Upper green LED comes on for programmed time (default). LED behavior for this indication is configurable using Aladdin utility.	One beep at current frequency, volume, mono/bi-tonal setting upon a successful label scan.
ROM Failure	200 msec on ↔ 200 msec off	Reader sounds one error beep at highest volume for 200 msec.
Limited Scanning Label Read	N/A	Reader 'chirps' six times at the highest frequency and current volume.
Imager Disabled	The LED blinks continuously 100 msec on ↔ 900 msec off	N/A

USER INDICATIONS FOR QD/QW2500

Table 32 User Indications for QD/QW2500

STATUS	TOP LED AND GOOD READ LED	BUZZER
Power-up	OFF	Rising Beeps' Sequence
USB Enumeration Phase	250 msec ^a ON ↔ 250 msec OFF	OFF
USB Suspend	Depends on Power Cable and specific configurations	OFF
Idle	OFF	OFF
While Reading	OFF	OFF
Decode Done	Solid ON Programmable Duration (1 s default)	Single Beep
Reader Disabled (POS) Communication with host not established	100 msec ON ↔ 900 msec OFF	OFF
Firmware Upgrade	250 msec ON ↔ 250 msec OFF	OFF
Host Download	250 msec ON ↔ 250 msec OFF	OFF
Enter Service Mode	No Effect	Beeps' Sequence
Label Programming	No Effect	Beep

a. "msec" stands for milliseconds, equivalent to 1/1000th of a second

USER INDICATIONS FOR QBT/QM2500 (GUN ONLY)

Table 33 User Indications for QBT/QM2500 Gun

STATUS	GOOD READ LED	BATTERY LED	BUZZER
Power-up	OFF	OFF	Rising Beeps' Sequence
USB Enumeration Phase	250 msec ^a ON ↔ 250 msec OFF	OFF	OFF
USB Suspend	Depends on Power Cable and specific configurations	OFF	OFF
Idle	OFF	OFF	OFF
While Reading	OFF	OFF	OFF
Decode Done	Solid ON Programmable Duration (1 s default)	OFF	Single Beep
Reader Disabled (POS) Communication with host not established	100 msec ON ↔ 900 msec OFF	OFF	OFF
Firmware Upgrade	250 msec ON ↔ 250 msec OFF	OFF	OFF
Host Download	250 msec ON ↔ 250 msec OFF	OFF	OFF
Paging Answer	5 cycles: 100 msec ON ↔ 900 msec OFF	OFF	5 Beeps (when LED ON)
Enter Service Mode	No Effect	OFF	Beeps' Sequence
Label Programming	No Effect	OFF	Beep
ACK Received on Transmission	OFF	OFF	Single Programmable Beep (OFF by default)
ACK NOT Received on Transmission	OFF	OFF	Wrong Beep
base station in USB Suspend	Depends on Power Cable and specific configurations	OFF	OFF
Configuration Alignment	250 msec ON ↔ 250 msec OFF	OFF	OFF
Charge in Progress through USB-C ^b	OFF	Blinking: 1 s ON . 1 s OFF Green (charge = 50% - 99%) Amber (charge = 1% - 49%) Red (charge less than 1%) Reader is unusable until 1% is reached	OFF
Charge Complete through USB-C	OFF	Solid Green It goes OFF when unplugged	OFF
Charge Fault	OFF	OFF	OFF
Charge in Progress through base station	OFF	OFF	OFF
Charge Complete through base station	OFF	OFF	OFF

STATUS	GOOD READ LED	BATTERY LED	BUZZER
<p>Battery Status indications when not charging, using double tap</p>	<p>OFF</p>	<p>Solid with programmable duration (3 s default) and then OFF Green (charge = 50% - 100%) Amber (charge = 2% - 50%) Red forced loop (charge less than 2%)</p>	<p>OFF</p>

- a. "msec" stands for milliseconds, equivalent to 1/1000th of a second
- b. In case of heavily depleted battery (e.g. if the reader has not been used for a long time), the reader being charged will not be operational for a certain amount of time, which can vary from just a few minutes to 30-40 minutes depending on battery discharge level and power supplied to the base station (i.e. longer time if the base station is connected to USB only without external power supply).

USER INDICATIONS FOR BC2090 BASE STATIONS

Table 34 User Indications for BC2090 Base Stations

STATUS	TRANSMISSION LEDES	CHARGING LEDES
Power-up	Solid ON	OFF
USB Enumeration	250 msec ^a ON ↔ 250 msec OFF	OFF
USB Suspend	Depends on Power Cable and specific configurations	OFF
Idle	Solid ON	OFF
While Reading	Solid ON	OFF
Label Transmitted to Host	OFF for 100 msec andd then Solid ON	OFF
Reader Disabled (POS) Communication with host not established	100 msec ON ↔ 900 msec OFF	OFF
Firmware Upgrade	250 msec ON ↔ 250 msec OFF	OFF
Host Download	250 msec ON ↔ 250 msec OFF	OFF
Configuration Alignment	250 msec ON ↔ 250 msec OFF	OFF
Enter Service Mode	No Effect (remains Solid ON)	OFF
Short button press (1-5 s) Paging request	Blink Green 500 msec ON ↔ 500 msec OFF (for 5 s while pressing button)	OFF
Long button press (6-10 s) Flush Piconet request	Blink Green 1 s ON ↔ 1 s OFF (for 5 s while pressing button)	OFF
Charge in Progress	No Effect	Fading: 1 s ON ↔ 1 s OFF Green (charge = 50% - 99%) Amber (charge = 0% - 49%)
Charge Complete	No Effect	Solid Green It goes OFF when unplugged
Charge Fault	No Effect	OFF
Electrical Fault	OFF	OFF

a. "msec" stands for milliseconds, equivalent to 1/1000th of a second

PROGRAMMING MODE

The following indications ONLY occur when the reader is in Programming Mode.

INDICATION	DESCRIPTION	LED	BEEPER
Enter Programming Mode	A valid programming label has been scanned.	LED blinks continuously	Reader sounds four low frequency beeps.
Rejection of Label	Label has been rejected.	N/A	Reader sounds three times at lowest frequency & current volume.
Acceptance of Partial Label	In cases where multiple labels must be scanned to program one feature, this indication acknowledges each portion as it is successfully scanned.	N/A	Reader sounds one short beep at highest frequency & current volume.
Acceptance of Programming	Configuration option(s) have been successfully programmed via labels and the reader has exited Programming Mode.	N/A	Reader sounds one high frequency beep and four low frequency beeps followed by reset beeps.
Cancel Item Entry	Cancel label has been scanned.	N/A	Reader sounds twice at low frequency & current volume.

TROUBLESHOOTING

PROBLEM	POSSIBLE CAUSE	POSSIBLE SOLUTION
Nothing happens when the scan button is pulled.	No power to the reader	Check system power. Ensure power supply is connected.
	Interface or power cables are loose.	Ensure all cable connections are secure.
LED comes on but bar code does not decode.	Reader not programmed for correct bar code type.	Ensure reader is programmed to read the type of bar code scanned.
	Bar code label is unreadable.	Check the label to ensure it is not defaced. Try scanning another bar code type.
	Distance between reader and bar code is incorrect.	Move reader closer to or further from the bar code.
Bar code is decoded but not transmitted to the host.	Reader not programmed for the correct host type.	Scan the appropriate host type bar code.

Figure 21 and Table 35 provide standard pinout information for the reader's cable.

Figure 21 Standard Cable Pinouts

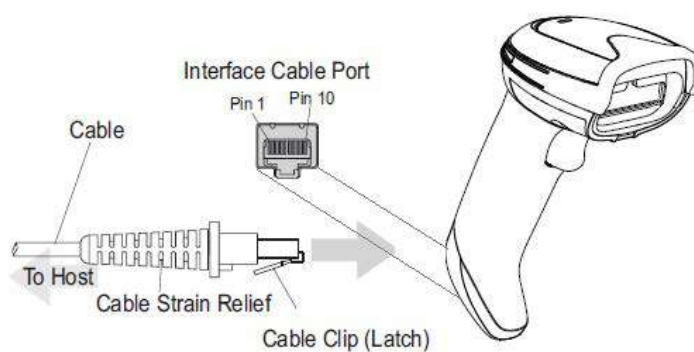

The signal descriptions in Table 35 apply to the connector on the reader and are for reference only.

Table 35 Standard Cable Pinouts — Reader Side

PIN	RS232	USB	KEYBOARD WEDGE
1	RTS (out)		
2		D+	CLKIN (KBD side)
3		D-	DATAIN (KBD side)
4	GND	GND	GND
5	RX		
6	TX		
7	VCC	VCC	VCC
8			CLKOUT (PC side)
9			DATAOUT (PC side)
10	CTS (in)		



WARNING: Only official Datalogic cables are allowed for installation and use. Non-standard P/N or wrong cable connection may lead to scanner and/or host port permanent damage.

Please refer to Datalogic Technical Support to get information about the cable's P/N most suitable for your application.

CLEANING PROCEDURE

Exterior surfaces and scan windows exposed to spills, smudges or debris accumulation require periodic cleaning to ensure best performance during scanning operations. Follow the procedures described in this instruction sheet to keep your QuickScan device in good operating condition



WARNING: Be sure to turn off power and unplug the device from electrical outlet before cleaning.



CAUTION: DO NOT use abrasive pads or cleaning agents.

Common Cleaning Solutions

The cleaners and disinfectants listed below are recommended for use on Datalogic's Quickscan 2500 Enclosures:

CLEANERS	DISINFECTANTS
Formula 409® Glass and Surface Cleaner	Clorox® Bleach (diluted 10:1)
70% Isopropyl Alcohol	Hydrogen Peroxide 3%
Windex® Multi-Surface	
100% Gentle dish soap and water	



NOTE: Disinfectants may be harsh on metal. They are recommended for use only on enclosures



**CAUTION: DO NOT spray or pour cleaner directly onto the unit.
DO NOT use solutions in their concentrated form.
DO NOT use aerosols, solvents or abrasives.
DO NOT use paper towels or rough cloths to clean windows.**

Cleaning enclosure and window surfaces

1. Moisten a soft cloth with a recommended cleaning solution. Be sure to apply the solution to your cloth first. Wring excessive liquid from the cloth.
2. Use the cloth to wipe down the surface of the unit. Use cotton swabs, lightly moistened, to reach in corners and crevices.
3. Use another clean dry cloth to remove any residue of the cleaning agent and ensure the unit is dry.



Cleaning electrical contact surfaces

Regular cleaning of electrical contacts is needed to guarantee a correct recharging of the battery. Both scanner and cradle contacts should be cleaned.

In case spills, smudges or debris accumulate on the cradle and/or the scanner, proper operation could be affected and a periodical cleaning is recommended as follows.

Avoid the use of brushes or any other hard tool to remove grime from electrical contacts, since these may damage or scratch the contact's plating. Usage of clorox bleach or chlorine compounds is NOT recommended to clean contacts.

Scanner Contacts

- Use a soft dry cloth to clean the contact area and the plastic surface around the contacts.
- Be sure to remove dust, dirt and any cloth residue.
- If the level of grime is significant, it is suggested the use of a soft white or pink pencil eraser to gently rub the contacts.
- Be sure to remove the rubber residuals by gently blowing them off with clean compressed air.



CAUTION: Be careful when using compressed air: protect yourself with goggles and point the nozzle far from eyes and not too close to the scanner surface. Read previously the warning label on the spray can.

Scanner and cradle deep cleaning

In case some hard grime, grease or liquid residual are present on electrical contacts, a deeper cleaning may be needed. If the above procedure is not enough to guarantee proper working of the system, the use of isopropyl alcohol is suggested (minimum 70%).

In this case it is suggested to use a cotton tipped applicator with isopropyl alcohol, gently wiping along the pins of the electrical connection. Be sure that cotton residue is not left on any pin of the electrical contacts.



NOTE: Remove power before initiating the deep cleaning routine.

After completion of the deep cleaning routine allow the system to dry completely before reconnecting to power. Depending on the environmental conditions wait at least 30 minutes or, if possible, leave the system unpowered overnight.

APPENDIX B

STANDARD DEFAULTS

The most common configuration settings are listed in the “Default” column of the table below. Page references are also provided for feature descriptions and programming bar codes for each parameter. A column has also been provided for recording of your preferred default settings for these same configurable features.

Table 36 Standard Defaults

PARAMETERS	DEFAULT	YOUR SETTING	PAGE NUMBER
GLOBAL INTERFACE FEATURES			
Host Commands — Obey/Ignore	Obey		29
USB Suspend Mode	Enable		29
RS-232 ONLY			
Baud Rate	9600		31
Data Bits	8 Data Bits		32
Stop Bits	1 Stop Bit		32
Parity	None		33
Handshaking Control	RTS		34
RS-232/USB-COM			
Intercharacter Delay	No Delay		36
Beep On ASCII BEL	Disable		37
Beep On Not on File	Enable		37
ACK NAK Options	Disable		38
ACK Character	‘ACK’		39
NAK Character	‘NAK’		39
ACK NAK Timeout Value	200 msec		40
ACK NAK Retry Count	3 Retries		39
ACK NAK Error Handling	Ignore Errors Detected		41

PARAMETERS	DEFAULT	YOUR SETTING	PAGE NUMBER
Indicate Transmission Failure	Enable		41
Disable Character	'D'		42
Enable Character	'E'		42
KEYBOARD WEDGE			
Setting Country Mode	U.S. Keyboard		45
Encoding Type	Don't Use Encoding		59
ALT Output Type	ALT Unicode		66
Caps Lock State	Caps Lock OFF		67
Numlock	Numlock Key Unchanged		67
Keyboard Numeric Keypad	Standard Keys		68
Keyboard Send Control Characters	Send Ctrl+Key		68
Wedge Quiet Interval	10 = Quiet Interval of 100 msec		69
Intercharacter Delay	00 = No Intercharacter Delay		69
Intercode Delay	00 = No Wedge Intercode Delay		70
USB Keyboard Speed	1ms		71
USB OEM			
USB-OEM Device Usage	Handheld		73
IBM 46XX INTERFACE			
IBM 46xx Interface Options	Obey Reader Configuration Host Commands		75
DATA FORMAT			
Global Prefix/Suffix	No Global Prefix Global Suffix = 0x0D (CR)		77
Case Conversion	Disable (no case conversion)		78
Character Conversion	0xFFFFFFFFFFFFFFFF (no character conversion)		78
Global AIM ID	Disable		79
GS1-128 AIM ID	Disable		79
Label ID: Pre-loaded Sets	USA Set		80
Label ID Control	Disable		81
Label ID Symbology Selection			82

PARAMETERS	DEFAULT	YOUR SETTING	PAGE NUMBER
READING PARAMETERS			
Scan Mode	Trigger Simple		88
Scanning Active Time	5 seconds		89
Flash On Time	10 = Flash is ON for 1 second		89
Flash Off Time	06 = Flash is OFF for 600ms		90
Double Read Timeout	0.6 second		90
Stand /Base Detection Behavior (QuickScan™ QD2500 only)	Switch to Stand Mode/Object Detection		92
Stand Mode/Object Detection Indica- tion (Stand Mode Flash)	Disable		93
Stand Mode/Object Detection Sensi- tivity	Medium		93
Stand Mode/Object Detection Illumi- nation Off Time	1 second		94
Corded Stand Mode	Disable		94
Dock Detection Beep	Disable		95
Power On Alert	Power-up Beep		96
Good Read Beep Type	Mono		96
Good Read Beep Frequency	High		97
Good Read Beep Length	80 msec		98
Good Read Beeper Volume	High		99
Silent Mode (not available for QW2500)	Disable		100
Good Read LED Duration	Enable		101
Good Read LED Duration	300 msec		101
Good Read: When to Indicate	After Decode		102
Green Spot Duration	Short (300 msec)		103
Illuminator Intensity	High		104
Aiming Pointer	Enable		105
Aiming Duration Timer	Aiming Off After Decoding		105
Pick Mode	Disable		106
Mobile Phone Mode	Enable		106

PARAMETERS	DEFAULT	YOUR SETTING	PAGE NUMBER
Mobile Phone Saturation Rate	00		107
Decode Negative Image	Disable		108
Multiple Labels per Frame	Disable		109
Multiple Labels Ordering by Code Symbology	Random Order		109
Multiple Labels Ordering by Code Length	Disable		110
CODE SELECTION - 1D SYMBOLOGIES			
Code EAN/UPC			
Coupon Control	Enable only UPC/EAN		112
UPC-A			
UPC-A Enable/Disable	Enable		113
UPC-A Check Character Transmission	Send		113
Expand UPC-A to EAN-13	Don't expand		114
UPC-A Number System Character Transmission	Transmit		114
UPC-E			
UPC-E Enable/Disable	Enable		115
UPC-E Check Character Transmission	Send		115
Expand UPC-E to EAN-13	Don't expand		116
Expand UPC-E to UPC-A	Don't expand		116
UPC-E Number System Character Transmission	Transmit		116
GTIN			
GTIN Formatting	Disable		117
EAN 13 (Jan 13)			
EAN-13 Enable/Disable	Enable		118
EAN-13 Check Character Transmission	Send		118
EAN-13 Flag 1 Character	Transmit		119
EAN-13 to ISBN Conversion	Disable		119

PARAMETERS	DEFAULT	YOUR SETTING	PAGE NUMBER
ISSN			
EAN-13 to ISSN Conversion	Disable		120
EAN 8			
EAN-8 Enable/Disable	Enable		121
EAN-8 Check Character Transmission	Send		121
Expand EAN-8 to EAN-13	Don't Expand		122
UPC/EAN Global Settings			
UPC/EAN Price Weight Check	Disable		123
UPC/EAN Quiet Zones	Two Modules		124
ADD-ONS			
Optional Add-ons	Disable P2 and P5		125
Optional Add-On Timer	70 msec		126
GS1 DATABAR™ OMNIDIRECTIONAL			
GS1 DataBar Omnidirectional Enable/Disable	Disable		127
GS1 DataBar Omnidirectional to GS1-128 Emulation	Disable		127
GS1 DataBar Expanded Enable/Disable	Disable		128
GS1 DataBar Expanded to GS1-128 Emulation	Disable		128
GS1 DataBar Expanded Length Control	Variable		129
GS1 DataBar Expanded Set Length 1	1		129
GS1 DataBar Expanded Set Length 2	74		130
GS1 DATABAR™ LIMITED			
GS1 DataBar Limited Enable/Disable	Disable		131
GS1 DataBar Limited to GS1-128 Emulation	Disable		131
CODE 39			
Code 39 Enable/Disable	Enable		132
Code 39 Check Character Calculation	Don't calculate		132

PARAMETERS	DEFAULT	YOUR SETTING	PAGE NUMBER
Code 39 Check Character Transmission	Send		133
Code 39 Start/Stop Character Transmission	Don't transmit		133
Code 39 Full ASCII	Disable		134
Code 39 Quiet Zones	Small Quiet Zones on two sides		134
Code 39 Length Control	Variable		135
Code 39 Set Length 1	1		135
Code 39 Set Length 2	50		136
TRIOPTIC CODE			
Trioptic Code Enable/Disable	Disable		137
CODE 39 DANISH PPT			
Code 39 Danish PPT Enable/Disable	Disable		137
CODE 39 PZN			
Code 39 PZN Enable/Disable	Disable		138
CODE 39 LA POSTE			
Code 39 La Poste Enable/Disable	Disable		138
CODE 32 (Italian Pharmaceutical Code)			
Code 32 Enable/Disable	Disable		139
Code 32 Check Character Transmission	Don't Send		139
Code 32 Start/Stop Character Transmission	Don't Transmit		140
Code 39 CIP HR (French Pharmaceutical Code)			
Code 39 CIP HR Enable/Disable	Disable		140
SPECIAL CODES			
Code 128			
Code 128 Enable/Disable	Enable		141
Expand Code 128 to Code 39	Don't Expand		141
Code 128 Check Character Transmission	Don't Send		142
Code 128 Function Character Transmission	Don't Send		142
Code 128 Quiet Zones	Auto		143

PARAMETERS	DEFAULT	YOUR SETTING	PAGE NUMBER
Code 128 Length Control	Variable		143
Code 128 Set Length 1	1		144
Code 128 Set Length 2	80		144
GS1-128			
GS1-128 Enable	Transmit in Code 128 Data Format		145
INTERLEAVED 2 of 5			
I 2 of 5 Enable/Disable	Disable		146
I 2 of 5 Check Character Calculation	Disable		147
I 2 of 5 Check Character Transmission	Send		148
I 2 of 5 Length Control	Variable		149
I 2 of 5 Set Length 1	6		149
I 2 of 5 Set Length 2	50		150
INTERLEAVED 2 of 5, FEBRABAN FORMAT (Desk Models Only)			
Interleaved 2 of 5, Febraban format Enable / Disable	Disable		151
INTERLEAVED 2 of 5 CIP HR			
Interleaved 2 of 5 CIP HR Enable/Disable	Disable		151
MATRIX 2 of 5			
Matrix 2 of 5 Enable/Disable	Disable		152
Matrix 2 of 5 Check Character Calculation	Enable		152
Matrix 2 of 5 Check Character Transmission	Don't Send		153
Matrix 2 of 5 Length Control	Variable Length		153
Matrix 2 of 5 Set Length 1	8 characters		154
Matrix 2 of 5 Set Length 2	50 characters		154
STANDARD 2 of 5			
Standard 2 of 5 Enable/Disable	Disable		155
Standard 2 of 5 Check Character Calculation	Disble		155
Standard 2 of 5 Check Character Transmission	Send		156

PARAMETERS	DEFAULT	YOUR SETTING	PAGE NUMBER
Standard 2 of 5 Length Control	Variable Length		156
Standard 2 of 5 Set Length 1	08 (8 characters)		157
Standard 2 of 5 Set Length 2	50 (50 characters)		157
COMPRESSED 2 of 5			
Compressed 2 of 5 Enable/Disable	Disable		158
Compressed 2 of 5 Check Character Calculation	Disable		158
Compressed 2 of 5 Check Character Transmission	Send		159
Compressed 2 of 5 Length Control	Variable Length		159
Compressed 2 of 5 Set Length 1	1 character		160
Compressed 2 of 5 Set Length 2	50 characters		160
DATALOGIC 2 OF 5			
Datalogic 2 of 5 Enable/Disable	Disable		161
Datalogic 2 of 5 Check Character Calculation	Disable		161
Datalogic 2 of 5 Check Character Transmission	Send		162
Datalogic 2 of 5 Length Control	Variable Length		162
Datalogic 2 of 5 Set Length 1	6 characters		163
Datalogic 2 of 5 Set Length 2	50 characters		163
INDUSTRIAL 2 of 5			
Industrial 2 of 5 Enable/Disable	Disable		164
Industrial 2 of 5 Check Character Calculation	Disable		164
Industrial 2 of 5 Check Character Transmission	Send		165
Industrial 2 of 5 Length Control	Variable		165
Industrial 2 of 5 Set Length 1	6 characters		166
Industrial 2 of 5 Set Length 2	50 characters		166
CODE IATA			
IATA Enable/Disable	Disable		167
IATA Check Character Transmission	Send		167

PARAMETERS	DEFAULT	YOUR SETTING	PAGE NUMBER
FOLLET 2 OF 5			
Follett 2 of 5 Enable/Disable	Disable		168
CODABAR			
Codabar Enable/Disable	Disable		169
Codabar Check Character Calculation	Disable		169
Codabar Check Character Transmission	Send		170
Codabar Start/Stop Character Transmission	Transmit		170
Codabar Start/Stop Character Set	abcd/abcd		171
Codabar Start/Stop Character Match	Don't Require Match		171
Codabar Quiet Zones	Quiet Zones on two sides		172
Codabar Length Control	Variable		173
Codabar Set Length 1	3 characters		173
Codabar Set Length 2	50 characters		174
ABC CODABAR			
ABC Codabar Enable/Disable	Disable		175
ABC Codabar Concatenation Mode	Static		175
ABC Codabar Dynamic Concatenation Timeout	200 msec		176
ABC Codabar Force Concatenation	Disable		176
ISBT-128			
ISBT 128 Concatenation	Disable		177
ISBT 128 Concatenation Mode	Static		177
ISBT 128 Dynamic Concatenation Timeout	200 msec		178
ISBT 128 Force Concatenation	Disable		179
ISBT 128 Advanced Concatenation Options	Disable		179
CODE 11			
Code 11 Enable/Disable	Disable		180
Code 11 Check Character Calculation	Check C and K		180

PARAMETERS	DEFAULT	YOUR SETTING	PAGE NUMBER
Code 11 Check Character Transmission	Send		181
Code 11 Length Control	Variable		181
Code 11 Set Length 1	4 characters		182
Code 11 Set Length 2	50 characters		182
CODE 93			
Code 93 Enable/Disable	Disable		183
Code 93 Check Character Calculation	Enable Check C and K		183
Code 93 Check Character Transmission	Disable		184
Code 93 Length Control	Variable		184
Code 93 Set Length 1	1 character		185
Code 93 Set Length 2	50 characters		185
Code 93 Quiet Zones	Auto		186
MSI			
MSI Enable/Disable	Disable		187
MSI Check Character Calculation	Calculate Mod 10		187
MSI Check Character Transmission	Send		188
MSI Length Control	Variable		188
MSI Set Length 1	1 character		189
MSI Set Length 2	50 characters		189
PLESSEY			
Plessey Enable/Disable	Disable		190
Plessey Check Character Calculation	Plessey std check char. verification		190
Plessey Check Character Transmission	Send		191
Plessey Length Control	Variable		191
Plessey Set Length 1	1 character		192
Plessey Set Length 2	50 characters		192
BC412			
BC412 Enable/Disable	Disable		193
BC412 Check Character Calculation	Calculate		193

PARAMETERS	DEFAULT	YOUR SETTING	PAGE NUMBER
BC412 Length Control	Variable		194
BC412 Set Length 1	1 character		195
BC412 Set Length 2	50 characters		195
CODE SELECTION - 2D SYMBOLOGIES			
2D Maximum Decoding Time	350 msec		198
2D Structured Append	Disable		199
2D Normal/Inverse Symbol Control	Normal		199
AZTEC CODE			
Aztec Code Enable / Disable	Enable		200
Aztec Code Length Control	Variable		200
Aztec Code Set Length 1	1 character		199
Aztec Code Set Length 2	3,832 characters		201
CHINA SENSIBLE CODE			
China Sensible Code Enable / Disable	Disable		202
China Sensible Code Length Control	Variable		202
China Sensible Code Set Length 1	1 character		203
China Sensible Code Set Length 2	7,827 characters		203
DATA MATRIX			
Data Matrix Enable / Disable	Enable		204
Data Matrix Square/Rectangular Style	Both Square and Rectangular Style		204
Data Matrix Length Control	Variable		205
Data Matrix Set Length 1	1 character		205
Data Matrix Set Length 2	3,116 characters		206
GS1 DOTCODE			
DotCode Enable	Disable		207
DotCode High Resolution Enable	Enable		207
DotCode Position-based Decoding	Disable		208
MAXICODE			
Maxicode Enable / Disable	Disable		209

PARAMETERS	DEFAULT	YOUR SETTING	PAGE NUMBER
Maxicode Primary Message Transmission	Disable		209
Maxicode Length Control	Variable		210
Maxicode Set Length 1	1 character		210
Maxicode Set Length 2	0145 characters		211
PDF417			
PDF417 Enable / Disable	Enable		212
PDF417 Length Control	Variable		212
PDF417 Set Length 1	1 character		213
PDF417 Set Length 2	2,710 characters		213
MICRO PDF417			
Micro PDF417 Enable / Disable	Enable		214
Micro PDF417 Code 128 GS1-128 Emulation	Micro PDF AIM ID and label type		214
Micro PDF417 Length Control	Variable		215
Micro PDF417 Set Length 1	1 character		215
Micro PDF417 Set Length 2	0366 characters		216
QR CODE			
QR Code Enable / Disable	Enable		217
QR Code Length Control	Variable		217
QR Code Set Length 1	1 character		218
QR Code Set Length 2	7,089 characters		218
MICRO QR CODE			
Micro QR Code Enable / Disable	Enable		219
Micro QR Code Length Control	Variable		219
Micro QR Code Set Length 1	1 character		220
Micro QR Code Set Length 2	0035 characters		220
UCC COMPOSITE			
UCC Optional Composite Timer	Timer Disabled		221
Postal Code Selection	Disable All Postal Codes		222
Postnet BB Control	Disable		223

PARAMETERS	DEFAULT	YOUR SETTING	PAGE NUMBER
MOTION FEATURES			
Motionless Timeout	2 seconds		227
Motion Sensitivity	Medium		227
High Motion Immunity	Disable		228
Motion Aiming Control	Enable		228
DOF Enhancement (Not available for QW2500)	Disable		229
POWER MANAGEMENT			
Powerdown Timeout	30 minutes		231
Battery Profiles	Maximum Performance		232
WIRELESS FEATURES			
Good Transmission Beep	Enable		235
Beeper Frequency	Low		235
Beep Duration	80 msec		236
Beep Volume	High		237
Disconnect Beep	Enable		237
Docking (Connecting) Beep	Enable		238
Leash Alarm	Disable		238
Automatic Configuration Update	Enable		240
Batch Mode	Disable		241
RF Batch Mode Transmit Delay	No delay		242
Direct Radio Autolink	Unlink Label Required		243
Source Radio Address Transmission	Do not include		244
Source Radio Address Delimiter Character	00 (no delimiter character)		244
Bluetooth Security Level	Level 1 - lowest		245
Wi-Fi Channels Exclusion	Automatic		247
Bluetooth Discoverable Mode Time-out	3 minutes		252
Bluetooth Friendly Name	QUICKSCAN QBT2500 [SERIAL_NUMBER_SCANNER]		253
Bluetooth HID Alt Mode	OFF		254

DEFAULT EXCEPTIONS

Table 37 - Default Exceptions by Interface Type

PARAMETER	DEFAULT EXCEPTION
Interfaces: USB-OEM	
Global Suffix	No Global Suffix
Double Read Timeout	500 msec
Interfaces: All Keyboard Wedge, USB Keyboard	
No unique settings	
Interface: RS232-WN	
Expand UPC-A to EAN-13	Enable
UPC-E Check Character Transmission	Disable
Parity	Odd Parity
Handshaking Control	RTS/CTS
Transmission Label ID Code	Prefix
GS1-128 AIM ID	Disable
UPCE Label ID Character(s)	C
EAN 8 Label ID Character(s)	B
EAN 13 Label ID Character(s)	A
Code ISBN Label ID Character(s)	A
Code 39 Label ID Character(s)	M
MInterleaved 2of5 Label ID Character(s)	I
Code Standard 2/5 Label ID Character(s)	H
Codabar Label ID Character(s)	N
Code 128 Label ID Character(s)	K
GS1-128 Label ID Character(s)	P
Datalogic 2 of 5 Label ID Character(s)	H
ISBT 128 Label ID Character(s)	K
UPCE P2 Label ID Character(s)	C
UPCE/P5 Label ID Character(s)	C
UPCE/GS1-128 Label ID Character(s)	C
EAN8/P2 Label ID Character(s)	B
EAN8/P5 Label ID Character(s)	B
EAN8/GS1-128 Label ID Character(s)	B
EAN13/P2 Label ID Character(s)	A
EAN13/P5 Label ID Character(s)	A
EAN13/GS1-128 Label ID Character(s)	A

PARAMETER	DEFAULT EXCEPTION
GS1 DataBar 14 (Omnidirectional) Label ID Character(s)	E
GS1 DataBar Expanded Label ID Character(s)	E
GS1 DataBar Limited Label ID Character(s)	E
Character Conversion	CR to `
Interface: RS232-OPOS	
Baud Rate	115200 Baud
Transmission Label ID Code	Prefix
GS1-128 AIM ID	Disable
UPCA Label ID Character(s)	C
UPCE Label ID Character(s)	D
EAN 8 Label ID Character(s)	A
EAN 13 Label ID Character(s)	B
Code ISBN Label ID Character(s)	@
Code 39 Label ID Character(s)	V
Code 32 Label ID Character(s)	X
Interleaved 2of5 Label ID Character(s)	N
Code Standard 2/5 Label ID Character(s)	P
Codabar Label ID Character(s)	R
Code 11 Label ID Character(s)	b
Code 128 Label ID Character(s)	T
GS1-128 Label ID Character(s)	k
UPCA/P2 Label ID Character(s)	F
UPCA/P5 Label ID Character(s)	G
UPCA/GS1-128 Label ID Character(s)	Q
UPCE P2 Label ID Character(s)	H
UPCE/P5 Label ID Character(s)	I
EAN8/P2 Label ID Character(s)	J
EAN8/P5 Label ID Character(s)	K
EAN8/GS1-128 Label ID Character(s)	*
EAN13/P2 Label ID Character(s)	L
EAN13/P5 Label ID Character(s)	M
EAN13/GS1-128 Label ID Character(s)	#
GS1 DataBar 14 (Omnidirectional) Label ID Character(s)	u
GS1 DataBar Expanded Label ID Character(s)	t
GS1 DataBar Limited Label ID Character(s)	v

APPENDIX C

SAMPLE BARCODES

The sample bar codes in this appendix are typical representations for their symbology types.

SAMPLE BARCODES

1D Barcodes

UPC-A



EAN-13



Code 39



Code 128



Interleaved 2 of 5



Code 32



Codabar



Code 93



Code 11



GS1 Databar™ (RSS)

GS1 DataBar™ variants must be enabled to read the barcodes below (see "GS1 DataBar™ Omnidirectional" on page 127).

GS1 DataBar™ Expanded Stacked



10293847560192837465019283746029478450366523

GS1 DataBar™ Expanded



1234890hjjio9900mnb

GS1 DataBar™ Limited



08672345650916

GS1 Databar™ (-14)

GS1 DataBar™ Omnidirectional Truncated



55432198673467

GS1 DataBar™ Omnidirectional Stacked



90876523412674

GS1 DataBar™ Omnidirectional Stacked



78123465709811

2D Barcodes

Aztec



Data Matrix



China Sensible



MaxiCode

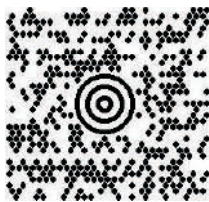

Test Message

PDF417



ABCabc

Micro PDF 417



BV17453

QR Code



35900G9

2D Barcodes (continued)

Micro QR Code



123456

UCC Composite



APPENDIX D

KEYPAD

Use the bar codes in this appendix to enter numbers as you would select digits/characters from a keypad.



1



2



3



4



5



6



7



1



2



3



4



5



6



7



8



9

APPENDIX E

SCANCODE TABLES

CONTROL CHARACTER EMULATION

Control character emulation selects from different scancode tables as listed in this appendix. Each of the control character sets below are detailed by interface type in the tables. These apply to Wedge and USB Keyboard platforms.

Control Character 00 : Characters from 00 to 0x1F are sent as control character Ctrl+Keys, special keys are located from 0x80 to 0xA1.

Control Character 01 : Characters from 00 to 0x1F are sent as control character Ctrl+Capital Key, special keys are located from 0x80 to 0xA1.

Control Character 02 : Special keys are located from 00 to 0x1F and characters from 0x80 to 0xFE are intended as an extended ASCII table (Microsoft Windows Codepage 1252 — see [page 337](#)).

Single Press and Release Keys

In the following tables, Ar↓ means Alt right pressed and Ar↑ means Alt right released and so on. Definitions for other keys are Al (Alt left), Cr (Control Right) Cl (Control Left) Sh (shift). This method can be used for combining Alt, Control or Shift with other keys.

Example: Consider a Control character set to 00. If AltRight+A is required before sending a label to the host, it could be done by setting three Prefix keys in this way: 0x99 0x41 0x9A.

INTERFACE TYPE PC AT PS/2, USB-KEYBOARD OR USB-KEYBOARD FOR APPLE

Table 38. Scancode Set When Control Character is 00 or 01

	x0	x1	x2	x3	x4	x5	x6	x7	x8	x9	xA	xB	xC	xD	xE	xF
0x	NULL C+@	SOH C(S)+A	STX C(S)+B	ETX C(S)+C	EOT C(S)+D	ENQ C(S)+E	ACK C(S)+F	BEL C(S)+G	BS CAN C(S)+X	HT TAB EM C(S)+Y	LF C(S)+J SUB C(S)+Z	VT C(S)+K ESC Esc	FF C(S)+L FS C+]	CR Enter GS C+]	SO C(S)+N RS C+^	SI C(S)+O US C(S)+_
1x	DLE C(S)+P	DC1 C(S)+Q	DC2 C(S)+R	DC3 C(S)+S	DC4 C(S)+T	NAK C(S)+U	SYN C(S)+V	ETB C(S)+W								
2x	SP	!	"	#	\$	%	&	'	()	*	+	,	-	.	/
3x	0	1	2	3	4	5	6	7	8	9	:	;	<	=	>	?
4x	@	A	B	C	D	E	F	G	H	I	J	K	L	M	N	O
5x	P	Q	R	S	T	U	V	W	X	Y	Z	[\]	^	_
6x	,	a	b	c	d	e	f	g	h	i	j	k	l	m	n	o
7x	p	q	r	s	t	u	v	w	x	y	z	{		}	~	Del
8x	€	Sh↓	Sh↑	Ins	Ent (keyp)	F1	F2	F3	F4	F5	F6	F7	F8	F9	F10	F11
9x	F12	Home	End	Pg Up	Pg Dwn	↑	↓	←	→	Ar↓	Ar↑	Al↓	Al↑	Cl↓	Cl↑	Cr↓
Ax	Cr↑		'	<i>f</i>	"	...	†	‡	^	%	Š	<	Š	<	Œ	
Bx	°	±	²	³	´	µ	¶	·	,	¸	°	»	¼	½	¾	¿
Cx	À	Á	Â	Ã	Ä	Å	Æ	Ç	È	É	Ê	Ë	Ì	Í	Î	Ï
Dx	Ð		Ò	Ó	Ô	Õ	Ö	×	Ø	Ù	Ú	Û	Ü	Ý	Þ	ß
Ex	à	á	â	ã	ä	å	æ	ç	è	é	ê	ë	ì	í	î	ï
Fx	ð	ñ	ò	ó	ô	õ	ö	÷	ø	ù	ú	û	ü	ý	þ	ÿ

Extended characters (sky blue) are sent through dedicated keys (when available in the selected country mode) or by using an Alt Mode sequence.

INTERFACE TYPE PC AT PS/2, USB-KEYBOARD OR USB-KEYBOARD FOR APPLE (CONTINUED)

Table 39. Scancode Set When Control Character is 02

	x0	x1	x2	x3	x4	x5	x6	x7	x8	x9	xA	xB	xC	xD	xE	xF
0x	Ar↓	Ar↑	Al↓	Al↑	Cl↓	Cl↑	Cr↓	Cr↑	BS	Tab	→	S+ Tab	Enter Keyprd	Enter	Ins	Pg Up
1x	Pg Dwn	Home	←	→	↑	F6	F1	F2	F3	F4	F5	ESC	F7	F8	F9	F10
2x	Space	!	“	#	\$	%	&	'	()	*	+	,	-	.	/
3x	0	1	2	3	4	5	6	7	8	9	:	;	<	=	>	?
4x	@	A	B	C	D	E	F	G	H	I	J	K	L	M	N	O
5x	P	Q	R	S	T	U	V	W	X	Y	Z	[\]	^	_
6x	`	a	b	c	d	e	f	g	h	i	j	k	l	m	n	o
7x	p	q	r	s	t	u	v	w	x	y	z	{		}	~	Del
8x	€		,	f	”	...	†	‡	^	% ₀₀	Š	<	Š	<	Œ	
9x		,	,	“	”	•	—	—	~	™	š	>	œ		ž	ÿ
Ax	NBSP	i	ç	£	□	¥	¡	§	“	©	ª	«	¬	-	®	—
Bx	°	±	²	³	´	µ	¶	·	,	ı	°	»	¼	½	¾	¿
Cx	À	Á	Â	Ã	Ä	Å	Æ	Ç	È	É	Ê	Ë	Ì	Í	Î	Ï
Dx	Ð	Ñ	Ò	Ó	Ô	Õ	Ö	×	Ø	Ù	Ú	Û	Ü	Ý	Þ	ß
Ex	à	á	â	ã	ä	å	æ	ç	è	é	ê	ë	ì	í	î	ï
Fx	ð	ñ	ò	ó	ô	õ	ö	÷	ø	ù	ú	û	ü	ý	þ	ÿ

INTERFACE TYPE PC AT PS/2 ALT MODE OR USB-KEYBOARD ALT MODE

Table 40. Scancode Set When Control Character is 00 or 01

	x0	x1	x2	x3	x4	x5	x6	x7	x8	x9	xA	xB	xC	xD	xE	Xf
0x	Alt+000	Alt+001	Alt+002	Alt+003	Alt+004	Alt+005	Alt+006	Alt+007	BS	HT TAB	Alt+010	Alt+011	Alt+012	CR Enter	Alt+014	Alt+015
1x	Alt+016	Alt+017	Alt+018	Alt+019	Alt+020	Alt+021	Alt+022	Alt+023	Alt+024	Alt+025	Alt+026	ESC Esc	Alt+028	Alt+029	Alt+030	Alt+031
2x	A+032	A+033	A+034	A+035	A+036	A+037	A+038	A+039	A+040	A+041	A+042	A+043	A+044	A+045	A+046	A+047
3x	A+048	A+049	A+050	A+051	A+052	A+053	A+054	A+055	A+056	A+057	A+058	A+059	A+060	A+061	A+062	A+063
4x	A+064	A+065	A+066	A+067	A+068	A+069	A+070	A+071	A+072	A+073	A+074	A+075	A+076	A+077	A+078	A+079
5x	A+080	A+081	A+082	A+083	A+084	A+085	A+086	A+087	A+088	A+089	A+090	A+091	A+092	A+093	A+094	A+095
6x	A+096	A+097	A+098	A+099	A+100	A+101	A+102	A+103	A+104	A+105	A+106	A+107	A+108	A+109	A+110	A+111
7x	A+112	A+113	A+114	A+115	A+116	A+117	A+118	A+119	A+120	A+121	A+122	A+123	A+124	A+125	A+126	A+127
8x	€	Sh↓	Sh↑	Ins	Ent (keyp)	F1	F2	F3	F4	F5	F6	F7	F8	F9	F10	F11
9x	F12	Home	End	Pg Up	Pg Dwn	↑	↓	←	→	Ar↓	Ar↑	Al↓	Al↑	Cl↓	Cl↑	Cr↓
Ax	Cr↑	A+0161	A+0162	A+0163	A+0164	A+0165	A+0166	A+0167	A+0168	A+0169	A+0170	A+0171	A+0172	A+0173	A+0174	A+0175
Bx	A+0176	A+0177	A+0178	A+0179	A+0180	A+0181	A+0182	A+0183	A+0184	A+0185	A+0186	A+0187	A+0188	A+0189	A+0190	A+0191
Cx	A+0192	A+0193	A+0194	A+0195	A+0196	A+0197	A+0198	A+0199	A+0200	A+0201	A+0202	A+0203	A+0204	A+0205	A+0206	A+0207
Dx	A+0208	A+0209	A+0210	A+0211	A+0212	A+0213	A+0214	A+0215	A+0216	A+0217	A+0218	A+0219	A+0220	A+0221	A+0222	A+0223
Ex	A+0224	A+0225	A+0226	A+0227	A+0228	A+0229	A+0230	A+0231	A+0232	A+0233	A+0234	A+0235	A+0236	A+0237	A+0238	A+0239
Fx	A+0240	A+0241	A+0242	A+0243	A+0244	A+0245	A+0246	A+0247	A+0248	A+0249	A+0250	A+0251	A+0252	A+0253	A+0254	A+0255

INTERFACE TYPE PC AT PS/2 ALT MODE OR USB-KEYBOARD ALT MODE (CONTINUED)

Table 41. Scancode Set When Control Character is 02

	x0	x1	x2	x3	x4	x5	x6	x7	x8	x9	xA	xB	xC	xD	xE	xF
0x	Ar↓	Ar↑	Al↓	Al↑	Cl↓	Cl↑	Cr↓	Cr↑	BS	Tab	→	S+ Tab	Enter Keyprd	Enter	Ins	Pg Up
1x	Pg Dwn	Home	←	↓	↑	F6	F1	F2	F3	F4	F5	ESC	F7	F8	F9	F10
2x	A+032	A+033	A+034	A+035	A+036	A+037	A+038	A+039	A+040	A+041	A+042	A+043	A+044	A+045	A+046	A+047
3x	A+048	A+049	A+050	A+051	A+052	A+053	A+054	A+055	A+056	A+057	A+058	A+059	A+060	A+061	A+062	A+063
4x	A+064	A+065	A+066	A+067	A+068	A+069	A+070	A+071	A+072	A+073	A+074	A+075	A+076	A+077	A+078	A+079
5x	A+080	A+081	A+082	A+083	A+084	A+085	A+086	A+087	A+088	A+089	A+090	A+091	A+092	A+093	A+094	A+095
6x	A+096	A+097	A+098	A+099	A+100	A+101	A+102	A+103	A+104	A+105	A+106	A+107	A+108	A+109	A+110	A+111
7x	A+112	A+113	A+114	A+115	A+116	A+117	A+118	A+119	A+120	A+121	A+122	A+123	A+124	A+125	A+126	A+127
8x	A+0128	A+0129	A+0130	A+0131	A+0132	A+0133	A+0134	A+0135	A+0136	A+0137	A+0138	A+0139	A+0140	A+0141	A+0142	A+0143
9x	A+0144	A+0145	A+0146	A+0147	A+0148	A+0149	A+0150	A+0151	A+0152	A+0153	A+0154	A+0155	A+0156	A+0157	A+0158	A+0159
Ax	A+0160	A+0161	A+0162	A+0163	A+0164	A+0165	A+0166	A+0167	A+0168	A+0169	A+0170	A+0171	A+0172	A+0173	A+0174	A+0175
Bx	A+0176	A+0177	A+0178	A+0179	A+0180	A+0181	A+0182	A+0183	A+0184	A+0185	A+0186	A+0187	A+0188	A+0189	A+0190	A+0191
Cx	A+0192	A+0193	A+0194	A+0195	A+0196	A+0197	A+0198	A+0199	A+0200	A+0201	A+0202	A+0203	A+0204	A+0205	A+0206	A+0207
Dx	A+0208	A+0209	A+0210	A+0211	A+0212	A+0213	A+0214	A+0215	A+0216	A+0217	A+0218	A+0219	A+0220	A+0221	A+0222	A+0223
Ex	A+0224	A+0225	A+0226	A+0227	A+0228	A+0229	A+0230	A+0231	A+0232	A+0233	A+0234	A+0235	A+0236	A+0237	A+0238	A+0239
Fx	A+0240	A+0241	A+0242	A+0243	A+0244	A+0245	A+0246	A+0247	A+0248	A+0249	A+0250	A+0251	A+0252	A+0253	A+0254	A+0255

DIGITAL INTERFACE

Table 42. Scancode Set When Control Character is 00 or 01

	X0	X1	X2	X3	X4	X5	X6	X7	X8	X9	XA	XB	XC	XD	XE	XF
0x	NULL C+@	SOH C(S)+A	STX C(S)+B	ETX C(S)+C	EOT C+D	ENQ C(S)+E	ACK C(S)+F	BEL C(S)+G	BS	HT TAB	LF C(S)+J	VT C(S)+K	FF C(S)+L	CR Enter	SO C(S)+N	SI C(S)+O
1x	DLE C(S)+P	DC1 C(S)+Q	DC2 C(S)+R	DC3 C(S)+S	DC4 C(S)+T	NAK C(S)+U	SYN C(S)+V	ETB C(S)+W	CAN C(S)+X	EM C(S)+Y	SUB C(S)+Z	ESC Esc	FS C(S)+\	GS C+]	RS C(S)+^	US C(S)+_
2x	Space	!	“	#	\$	%	&	'	()	*	+	,	-	.	/
3x	0	1	2	3	4	5	6	7	8	9	:	;	<	=	>	?
4x	@	A	B	C	D	E	F	G	H	I	J	K	L	M	N	O
5x	P	Q	R	S	T	U	V	W	X	Y	Z	[\]	^	_
6x	,	a	b	c	d	e	f	g	h	i	j	k	l	m	n	o
7x	p	q	r	s	t	u	v	w	x	y	z	{		}	~	Del
8x		Sh↓	Sh↑	Ins	Ent (keyp)	F1	F2	F3	F4	F5	F6	F7	F8	F9	F10	F11
9x	F12	F13	F14	F15	F16	↑	↓	←	→					Cl↓	Cl↑	

Table 43. Scancode Set When Control Character is 02

	X0	X1	X2	X3	X4	X5	X6	X7	X8	X9	XA	XB	XC	XD	XE	XF
0x					Cl↓	Cl↑			BS	Tab	à	S+ Tab	Enter Keypd	Enter	Ins	
1x			←	↓	↑	F6	F1	F2	F3	F4	F5	ESC	F7	F8	F9	F10
2x	Space	!	“	#	\$	%	&	'	()	*	+	,	-	.	/
3x	0	1	2	3	4	5	6	7	8	9	:	;	<	=	>	?
4x	@	A	B	C	D	E	F	G	H	I	J	K	L	M	N	O
5x	P	Q	R	S	T	U	V	W	X	Y	Z	[\]	^	_
6x	,	a	b	c	d	e	f	g	h	i	j	k	l	m	n	o
7x	p	q	r	s	t	u	v	w	x	y	z	{		}	~	Del

IBM31XX 102-KEY

Table 44. Scancode Set When Control Character is 00 or 01

	x0	x1	x2	x3	x4	x5	x6	x7	x8	x9	xA	xB	xC	xD	xE	xF
0x	NULL C+@	SOH C(S)+A	STX C(S)+B	ETX C(S)+C	EOT C+D	ENQ C(S)+E	ACK C(S)+F	BEL C(S)+G	BS	HT TAB	LF C(S)+J	VT C(S)+K	FF C(S)+L	CR Enter	SO C(S)+N	SI C(S)+O
1x	DLE C(S)+P	DC1 C(S)+Q	DC2 C(S)+R	DC3 C(S)+S	DC4 C(S)+T	NAK C(S)+U	SYN C(S)+V	ETB C(S)+W	CAN C(S)+X	EM C(S)+Y	SUB C(S)+Z	ESC Esc	FS C(S)+\	GS C+]	RS C(S)+^	US C(S)+_
2x	Space	!	“	#	\$	%	&	'	()	*	+	,	-	.	/
3x	0	1	2	3	4	5	6	7	8	9	:	;	<	=	>	?
4x	@	A	B	C	D	E	F	G	H	I	J	K	L	M	N	O
5x	P	Q	R	S	T	U	V	W	X	Y	Z	[\]	^	_
6x	,	a	B	c	d	e	f	g	h	i	j	k	l	m	n	o
7x	p	q	R	s	t	u	v	w	x	y	z	{		}		Del
8x		Sh↓	Sh↑	Ins	Ent (keyp)	F1	F2	F3	F4	F5	F6	F7	F8	F9	F10	F11
9x	F12	Enter	Reset	Insert	Delete	Field -	Field +	Enter paddle	Printl	Ar↓	Ar↑	Al↓	Al↑	Cl↓	Cl↑	Cr↓
Ax	Cr↑															

Table 45. Scancode Set When Control Character is 02

	X0	X1	X2	X3	X4	X5	X6	X7	X8	X9	xA	xB	xC	xD	xE	xF
0x	Ar↓	Ar↑	Al↓	Al↑	Cl↓	Cl↑	Cr↓	Cr↑	BS	Tab	→	S+ Tab	Enter Keyupd	Enter	Ins	Pg Up
1x	Pg Dwn	Home	←	↓	↑	F1	F2	F3	F4	F5	F5	ESC	F7	F8	F9	F10
2x	Space	!	“	#	\$	&	,	()	*		+	,	-	.	/
3x	0	1	2	3	4	6	7	8	9	:	:	;	<	=	>	?
4x	@	A	B	C	D	F	G	H	I	J	J	K	L	M	N	O
5x	P	Q	R	S	T	V	W	X	Y	Z	Z	[\]	^	_
6x	,	a	B	c	d	f	g	h	i	j	j	k	l	m	n	o
7x	p	q	R	s	t	v	w	x	y	z	z	{		}		Del

IBM XT

Table 46. Scancode Set When Control Character is 00 or 01

	x0	x1	x2	x3	x4	x5	x6	x7	x8	x9	xA	xB	xC	xD	xE	xF
0x	NULL C+@	SOH C(S)+A	STX C(S)+B	ETX C(S)+C	EOT C+D	ENQ C(S)+E	ACK C(S)+F	BEL C(S)+G	BS C(S)+H	HT TAB	LF C(S)+J	VT C(S)+K	FF C(S)+L	CR Enter	SO C(S)+N	SI C(S)+O
1x	DLE C(S)+P	DC1 C(S)+Q	DC2 C(S)+R	DC3 C(S)+S	DC4 C(S)+T	NAK C(S)+U	SYN C(S)+V	ETB C(S)+W	CAN C(S)+X	EM C(S)+Y	SUB C(S)+Z	ESC Esc	FS C(S)+\	GS C+]	RS C(S)+^	US C(S)+_
2x	Space	!	“	#	\$	%	&	'	()	*	+	,	-	.	/
3x	0	1	2	3	4	5	6	7	8	9	:	;	<	=	>	?
4x	@	A	B	C	D	E	F	G	H	I	J	K	L	M	N	O
5x	P	Q	R	S	T	U	V	W	X	Y	Z	[\]	^	_
6x	,	a	B	c	d	e	f	g	h	i	j	k	l	m	n	o
7x	p	q	R	s	t	u	v	w	x	y	z	{		}		Del
8x		Sh↓	Sh↑	Ins	Ent (keyp)	F1	F2	F3	F4	F5	F6	F7	F8	F9	F10	F11
9x	F12	Home	End	Pg Up	Pg Dwn	↑	↓	←	→	Ar↓	Ar↑	All	Al↑	Cl↓	Cl↑	Cr↓
Ax	Cr↑															

Table 47. Scancode Set when Control Character 02

	X0	X1	X2	X3	X4	X5	X6	X7	X8	X9	xA	xB	xC	xD	xE	xF
0x	Ar↓	Ar↑	Al↓	Al↑	Cl↓	Cl↑	Cr↓	Cr↑	BS	Tab	→	S+Tab	Enter Keypd	Enter	Ins	Pg Up
1x	Pg Dwn	Home	←	↓	↑	F6	F1	F2	F3	F4	F5	ESC	F7	F8	F9	F10
2x	Space	!	“	#	\$	%	&	‘	()	*	+	,	-	.	/
3x	0	1	2	3	4	5	6	7	8	9	:	;	<	=	>	?
4x	@	A	B	C	D	E	F	G	H	I	J	K	L	M	N	O
5x	P	Q	R	S	T	U	V	W	X	Y	Z	[\]	^	_
6x	,	a	B	c	d	e	f	g	h	i	j	k	l	m	n	o
7x	p	q	R	s	t	u	v	w	x	y	z	{		}		Del

MICROSOFT WINDOWS CODEPAGE 1252

Windows-1252 is a character encoding of the Latin alphabet, used by default in the legacy components of Microsoft Windows in English and some other Western languages.

	00	01	02	03	04	05	06	07	08	09	0A	0B	0C	0D	0E	0F
00	NUL 0000	STX 0001	SOT 0002	ETX 0003	EOT 0004	ENO 0005	ACK 0006	BEL 0007	BS 0008	HT 0009	LF 000A	VT 000B	FF 000C	CR 000D	SO 000E	SI 000F
10	DLE 0010	DC1 0011	DC2 0012	DC3 0013	DC4 0014	NAK 0015	SYN 0016	ETB 0017	CAN 0018	EM 0019	SUB 001A	ESC 001B	FS 001C	GS 001D	RS 001E	US 001F
20	SP 0020	! 0021	" 0022	# 0023	\$ 0024	% 0025	& 0026	* 0027	(0028) 0029	* 002A	+ 002B	, 002C	- 002D	. 002E	/ 002F
30	0 0030	1 0031	2 0032	3 0033	4 0034	5 0035	6 0036	7 0037	8 0038	9 0039	: 003A	; 003B	< 003C	= 003D	> 003E	? 003F
40	@ 0040	A 0041	B 0042	C 0043	D 0044	E 0045	F 0046	G 0047	H 0048	I 0049	J 004A	K 004B	L 004C	M 004D	N 004E	O 004F
50	P 0050	Q 0051	R 0052	S 0053	T 0054	U 0055	V 0056	W 0057	X 0058	Y 0059	Z 005A	[005B	\ 005C] 005D	^ 005E	_ 005F
60	` 0060	a 0061	b 0062	c 0063	d 0064	e 0065	f 0066	g 0067	h 0068	i 0069	j 006A	k 006B	l 006C	m 006D	n 006E	o 006F
70	p 0070	q 0071	r 0072	s 0073	t 0074	u 0075	v 0076	w 0077	x 0078	y 0079	z 007A	{ 007B	 007C	} 007D	~ 007E	DEL 007F
80	€ 20AC	• 20A2	ƒ 201A	£ 0132	„ 201E	… 2026	† 2020	‡ 2021	ˆ 02C6	‰ 2030	Š 0160	< 2038	€ 0162	• 017D	Ž 017D	• 017D
90	• 20A2	ˆ 2018	˜ 2019	˘ 201C	˙ 201D	˚ 2022	– 2013	— 2014	˛ 02DC	• 2122	Š 0161	› 203A	€ 0163	• 017E	Ž 017E	Ÿ 0178
A0	NESE 00A0	ı 00A1	ı 00A2	£ 00A3	• 00A4	¥ 00A5	ı 00A6	• 00A7	• 00A8	• 00A9	• 00AA	• 00AB	• 00AC	• 00AD	• 00AE	• 00AF
B0	• 00B0	• 00B1	• 00B2	• 00B3	• 00B4	• 00B5	• 00B6	• 00B7	• 00B8	• 00B9	• 00BA	• 00BB	• 00BC	• 00BD	• 00BE	• 00BF
C0	À 00C0	Á 00C1	Â 00C2	Ã 00C3	Ä 00C4	Å 00C5	Æ 00C6	Ç 00C7	È 00C8	É 00C9	Ê 00CA	Ë 00CB	Ì 00CC	Í 00CD	Î 00CE	Ï 00CF
D0	Ð 00D0	Ñ 00D1	Ò 00D2	Ó 00D3	Ô 00D4	Õ 00D5	Ö 00D6	× 00D7	Ø 00D8	Ù 00D9	Ú 00DA	Û 00DB	Ü 00DC	Ý 00DD	Þ 00DE	ß 00DF
E0	à 00E0	á 00E1	â 00E2	ã 00E3	ä 00E4	å 00E5	æ 00E6	ç 00E7	è 00E8	é 00E9	ê 00EA	ë 00EB	ì 00EC	í 00ED	î 00EE	ï 00EF
F0	ø 00F0	ñ 00F1	ò 00F2	ó 00F3	ô 00F4	õ 00F5	ö 00F6	÷ 00F7	ø 00F8	ù 00F9	ú 00FA	û 00FB	ü 00FC	ý 00FD	þ 00FE	ÿ 00FF

APPENDIX F

ASCII CHART

ASCII Char.	Hex No.	ASCII Char.	Hex No.	ASCII Char.	Hex No.	ASCII Char.	Hex No.
NUL	00	SP	20	@	40	'	60
SOH	01	!	21	A	41	a	61
STX	02	"	22	B	42	b	62
ETX	03	#	23	C	43	c	63
EOT	04	\$	24	D	44	d	64
ENQ	05	%	25	E	45	e	65
ACK	06	&	26	F	46	f	66
BEL	07	'	27	G	47	g	67
BS	08	(28	H	48	h	68
HT	09)	29	I	49	i	69
LF	0A	*	2A	J	4A	j	6A
VT	0B	+	2B	K	4B	k	6B
FF	0C	,	2C	L	4C	l	6C
CR	0D	-	2D	M	4D	m	6D
SO	0E	.	2E	N	4E	n	6E
SI	0F	/	2F	O	4F	o	6F
DLE	10	0	30	P	50	p	70
DC1	11	1	31	Q	51	q	71
DC2	12	2	32	R	52	r	72
DC3	13	3	33	S	53	s	73
DC4	14	4	34	T	54	t	74
NAK	15	5	35	U	55	u	75
SYN	16	6	36	V	56	v	76
ETB	17	7	37	W	57	w	77
CAN	18	8	38	X	58	x	78
EM	19	9	39	Y	59	y	79
SUB	1A	:	3A	Z	5A	z	7A
ESC	1B	;	3B	[5B	{	7B
FS	1C	<	3C	\	5C		7C
GS	1D	=	3D]	5D	}	7D
RS	1E	>	3E	^	5E	~	7E
US	1F	?	3F	_	5F	DEL	7F

© 2022-2023 Datalogic S.p.A. and /or its affiliates • All rights reserved • Without limiting the rights under copyright, no part of this documentation may be reproduced, stored in or introduced into a retrieval system, or transmitted in any form or by any means, or for any purpose, without the express written permission of Datalogic S.p.A. and/or its affiliates • Datalogic and the Datalogic logo are registered trademarks of Datalogic S.p.A. in many countries, including the U.S. and the E.U.



Datalogic S.r.l.

Via S. Vitalino, 13 | 40012 Calderara di Reno | Bologna - Italy
Tel. +39 051 3147011 | Fax +39 051 3147205



800000040

(Rev E)

September 2023