

# Gryphon™ 2D Family

## Gryphon I GD/GBT/GM4500

General Purpose Handheld  
Area Imager Bar Code Reader



**Product Reference Guide**

**Datalogic S.r.l.**

Via S. Vitalino, 13  
40012 Calderara di Reno (BO)  
Italy  
Tel. +39 051 3147011  
Fax +39 051 3147205

**©2011 - 2019 Datalogic S.p.A. and/or its affiliates**

An Unpublished Work - All rights reserved. No part of the contents of this documentation or the procedures described therein may be reproduced or transmitted in any form or by any means without prior written permission of Datalogic S.r.l. or its subsidiaries or affiliates ("Datalogic" or "Datalogic S.r.l."). Owners of Datalogic products are hereby granted a non-exclusive, revocable license to reproduce and transmit this documentation for the purchaser's own internal business purposes. Purchaser shall not remove or alter any proprietary notices, including copyright notices, contained in this documentation and shall ensure that all notices appear on any reproductions of the documentation.

Should future revisions of this manual be published, you can acquire printed versions by contacting your Datalogic representative. Electronic versions may either be downloadable from the Datalogic website ([www.datalogic.com](http://www.datalogic.com)) or provided on appropriate media. If you visit our website and would like to make comments or suggestions about this or other Datalogic publications, please let us know via the "Contact Datalogic" page.

**Disclaimer**

Datalogic has taken reasonable measures to provide information in this manual that is complete and accurate, however, Datalogic reserves the right to change any specification at any time without prior notice.

Datalogic and the Datalogic logo are registered trademarks of Datalogic S.p.A. in many countries, including the U.S. and the E.U. Gryphon is a trademark of Datalogic S.p.A. and/or its affiliates, registered in the U.S. All other brand and product names may be trademarks of their respective owners.

**Patents**

See [www.patents.datalogic.com](http://www.patents.datalogic.com) for patent list.



# Table of Contents

<b>INTRODUCTION</b> .....	<b>1</b>
<b>About this Manual</b> .....	<b>1</b>
Overview .....	1
Manual Conventions .....	2
<b>Technical Support</b> .....	<b>2</b>
Datalogic Website Support .....	2
Reseller Technical Support .....	2
Telephone Technical Support .....	2
<b>About the Scanner</b> .....	<b>3</b>
Using the GD4500 Reader .....	3
<b>Using the WLC4090 Radio Base</b> .....	<b>4</b>
Radio Base LEDs .....	4
<b>Battery Safety</b> .....	<b>5</b>
<b>Programming the Reader</b> .....	<b>7</b>
Configuration Methods .....	7
<b>SETUP</b> .....	<b>9</b>
<b>Unpacking</b> .....	<b>9</b>
<b>Setting Up the Scanner</b> .....	<b>9</b>
Connect Host Interface .....	10
Stand Installation .....	12
Hands-Free Stand/Holder .....	12
<b>Setting Up the Reader</b> .....	<b>13</b>
Positioning the Base Station .....	14
<b>Reader, Cradle and LEDs Description</b> .....	<b>17</b>
<b>Connecting the Base Station</b> .....	<b>18</b>
Securing the DC Power Cord (Optional) .....	19
<b>System and Network Layouts</b> .....	<b>21</b>
Stand Alone Layouts .....	21
<b>Using the GBT/GM4500 Scanner</b> .....	<b>22</b>
Scanner LEDs .....	22
<b>Using the WLC4090 Radio Base</b> .....	<b>23</b>
Radio Base LEDs .....	23
<b>Replacing the Battery Pack</b> .....	<b>24</b>
<b>Using the Gryphon™ I GD/GBT/GM4500</b> .....	<b>26</b>
<b>Linking the Reader</b> .....	<b>28</b>
Link Scanner as Serial Device to a Bluetooth Host .....	28
Link Scanner as HID device to a Bluetooth host .....	29
<b>Power Off</b> .....	<b>29</b>
<b>Interface Selection</b> .....	<b>30</b>
Configuring the Interface .....	30
<b>Customizing Configuration Settings</b> .....	<b>34</b>
Using the Programming Bar Codes .....	34
Interface Settings .....	35
Configuring Other Features .....	35
Software Version Transmission .....	35
<b>CONFIGURATION USING BAR CODES</b> .....	<b>37</b>
<b>Configuration Parameters</b> .....	<b>37</b>
<b>Global Interface Features</b> .....	<b>39</b>
Host Commands — Obey/Ignore .....	39
USB Suspend Mode .....	39
<b>RS-232 ONLY INTERFACE 41</b>	
<b>RS-232 Standard Factory Settings</b> .....	<b>41</b>

Baud Rate .....	41
Data Bits .....	42
Stop Bits .....	43
Parity .....	43
Handshaking Control .....	44
<b>RS-232/USB-COM INTERFACES 45</b>	
Standard Factory Settings .....	45
Intercharacter Delay .....	46
Beep On ASCII BEL .....	47
Beep On Not on File .....	47
ACK NAK Options .....	48
ACK Character .....	49
NAK Character .....	49
ACK NAK Timeout Value .....	50
ACK NAK Retry Count .....	51
ACK NAK Error Handling .....	52
Indicate Transmission Failure .....	53
Disable Character .....	53
Enable Character .....	54
<b>KEYBOARD INTERFACE 55</b>	
Country Mode .....	56
Setup on PC to use ALT Universal .....	56
Setting Country Mode .....	57
Setting Encoding Type .....	71
Setting ALT output type .....	78
Caps Lock State .....	79
Numlock .....	79
Keyboard Numeric Keypad .....	80
Keyboard Send Control Characters .....	81
Wedge Quiet Interval .....	82
Intercharacter Delay .....	83
Intercode Delay .....	84
USB Keyboard Speed .....	85
<b>USB-OEM INTERFACE 87</b>	
Introduction .....	87
Standard Factory Settings .....	87
USB-OEM Device Usage .....	88
USB-OEM Interface Options .....	88
<b>IBM 46XX INTERFACE 89</b>	
46xx Number of Host Resets .....	90
Transmit Labels in code 39 Format .....	92
Interface Options .....	92
<b>DATA FORMAT 93</b>	
Global Prefix/Suffix .....	94
Global AIM ID .....	95
GS1-128 AIM ID .....	95
Label ID .....	96
Label ID: Pre-loaded Sets .....	96
Label ID: Set Individually Per Symbology .....	97
Label ID Control .....	97
Label ID Symbology Selection .....	98
Case Conversion .....	103
Character Conversion .....	104
<b>READING PARAMETERS 105</b>	
Double Read Timeout .....	106
Reading Performance .....	108
<b>LED and Speaker Indicators 109</b>	
Power On Alert .....	109
Good Read: When to Indicate .....	110
Good Read Beep Type .....	111
Good Read Beep Frequency .....	111
Good Read Speaker Volume .....	112

Good Read Beep Length .....	113
Enable/Disable Good Read Indicator .....	114
.....	114
<b>Scanning Features .....</b>	<b>115</b>
Scan Mode .....	115
Flash On Time .....	116
Flash Off Time .....	117
Stand Mode Indication .....	118
Stand Mode Sensitivity .....	120
Stand Mode Illumination Off Time .....	121
Scanning Active Time .....	121
Stand Illumination Control .....	122
Motion Still Timeout .....	123
Pick Mode .....	124
Aiming Pointer .....	124
Aiming Duration Timer .....	125
Green Spot Duration .....	126
Mobile Phone Mode .....	127
Partial Label Reading Control .....	127
Decode Negative Image .....	128
Image Capture .....	128
Corded Stand Mode .....	129
Corded Stand Beep .....	130
Multiple Labels per Frame .....	131
Multiple Labels Ordering by Code Symbology .....	132
Multiple Labels Ordering by Code Length .....	132
<b>1D SYMBOLOGIES 133</b>	
<b>Introduction .....</b>	<b>133</b>
<b>Standard Factory Settings for Symbologies .....</b>	<b>133</b>
<b>Disable All Symbologies .....</b>	<b>134</b>
<b>Coupon Control .....</b>	<b>134</b>
<b>UPC-A .....</b>	<b>135</b>
UPC-A Enable/Disable .....	135
UPC-A Check Character Transmission .....	135
Expand UPC-A to EAN-13 .....	136
UPC-A Number System Character Transmission .....	136
<b>UPC-E .....</b>	<b>138</b>
UPC-E Enable/Disable .....	138
UPC-E Check Character Transmission .....	138
Expand UPC-E to EAN-13 .....	139
Expand UPC-E to UPC-A .....	139
UPC-E Number System Character Transmission .....	139
<b>EAN 13 .....</b>	<b>140</b>
EAN 13 Enable/Disable .....	140
EAN 13 Check Character Transmission .....	140
EAN-13 Flag 1 Character .....	141
EAN-13 ISBN Conversion .....	141
ISSN Enable/Disable .....	142
<b>EAN 8 .....</b>	<b>143</b>
EAN 8 Enable/Disable .....	143
EAN 8 Check Character Transmission .....	143
Expand EAN 8 to EAN 13 .....	144
.....	144
<b>UPC/EAN Global Settings .....</b>	<b>145</b>
UPC/EAN Price Weight Check .....	145
<b>Add-Ons .....</b>	<b>146</b>
Optional Add-ons .....	146
Optional Add-On Timer .....	147
<b>GS1 DataBar™ Omnidirectional .....</b>	<b>148</b>
GS1 DataBar Omnidirectional Enable/Disable .....	148
GS1 DataBar Omnidirectional GS1-128 Emulation .....	148
GS1 DataBar™ Omnidirectional 2D Component .....	149

<b>GS1 DataBar™ Expanded</b> .....	<b>150</b>
GS1 DataBar Expanded Enable/Disable .....	150
GS1 DataBar Expanded GS1-128 Emulation .....	150
GS1 DataBar Expanded Length Control .....	151
GS1 DataBar Expanded Set Length 1 .....	151
GS1 DataBar Expanded Set Length 2 .....	152
<b>GS1 DataBar™ Limited</b> .....	<b>153</b>
GS1 DataBar Limited Enable/Disable .....	153
GS1 DataBar Limited GS1-128 Emulation .....	153
<b>Code 39</b> .....	<b>154</b>
Code 39 Enable/Disable .....	154
Code 39 Check Character Calculation .....	154
Code 39 Check Character Transmission .....	155
Code 39 Start/Stop Character Transmission .....	156
Code 39 Full ASCII .....	156
Code 39 Quiet Zones .....	157
Code 39 Length Control .....	158
Code 39 Set Length 1 .....	159
Code 39 Set Length 2 .....	160
<b>Code 32 (Italian Pharmaceutical)</b> .....	<b>161</b>
Code 32 Enable/Disable .....	161
Code 32 Feature Setting Exceptions .....	161
Code 32 Check Character Transmission .....	161
Code 32 Start/Stop Character Transmission .....	162
<b>Code 39 CIP (French Pharmaceutical)</b> .....	<b>162</b>
Code 39 CIP Enable/Disable .....	162
<b>Code 128</b> .....	<b>163</b>
Code 128 Enable/Disable .....	163
Expand Code 128 to Code 39 .....	163
Code 128 Check Character Transmission .....	164
Code 128 Function Character Transmission .....	164
Code 128 Quiet Zones .....	165
Code 128 Length Control .....	166
Code 128 Set Length 1 .....	166
Code 128 Set Length 2 .....	167
<b>GS1-128</b> .....	<b>168</b>
GS1-128 Enable .....	168
<b>Interleaved 2 of 5 (I 2 of 5)</b> .....	<b>169</b>
I 2 of 5 Enable/Disable .....	169
I 2 of 5 Check Character Calculation .....	170
I 2 of 5 Check Character Transmission .....	171
I 2 of 5 Length Control .....	171
I 2 of 5 Set Length 1 .....	172
I 2 of 5 Set Length 2 .....	173
<b>Interleaved 2 of 5 CIP HR</b> .....	<b>174</b>
Interleaved 2 of 5 CIP HR Enable/Disable .....	174
<b>Datalogic 2 of 5</b> .....	<b>174</b>
Datalogic 2 of 5 Enable/Disable .....	174
Datalogic 2 of 5 Check Character Calculation .....	175
Datalogic 2 of 5 Check Character Transmission .....	175
Datalogic 2 of 5 Length Control .....	176
Datalogic 2 of 5 Set Length 1 .....	176
Datalogic 2 of 5 Set Length 2 .....	177
<b>Codabar</b> .....	<b>178</b>
Codabar Enable/Disable .....	178
Codabar Check Character Calculation .....	178
Codabar Check Character Transmission .....	179
Codabar Start/Stop Character Transmission .....	179
Codabar Start/Stop Character Set .....	180
Codabar Start/Stop Character Match .....	180
Codabar Quiet Zones .....	181
Codabar Length Control .....	182

Codabar Set Length 1 .....	182
Codabar Set Length 2 .....	183
<b>ABC Codabar .....</b>	<b>184</b>
ABC Codabar Enable/Disable .....	184
ABC Codabar Concatenation Mode .....	184
ABC Codabar Dynamic Concatenation Timeout .....	185
ABC Codabar Force Concatenation .....	185
<b>Code 11 .....</b>	<b>186</b>
Code 11 Enable/Disable .....	186
Code 11 Check Character Calculation .....	186
Code 11 Check Character Transmission .....	187
Code 11 Length Control .....	187
Code 11 Set Length 1 .....	188
Code 11 Set Length 2 .....	189
<b>Standard 2 of 5 .....</b>	<b>190</b>
Standard 2 of 5 Enable/Disable .....	190
Standard 2 of 5 Check Character Calculation .....	190
Standard 2 of 5 Check Character Transmission .....	191
Standard 2 of 5 Length Control .....	191
Standard 2 of 5 Set Length 1 .....	192
Standard 2 of 5 Set Length 2 .....	193
<b>Industrial 2 of 5 .....</b>	<b>194</b>
Industrial 2 of 5 Enable/Disable .....	194
Industrial 2 of 5 Check Character Calculation .....	194
Industrial 2 of 5 Check Character Transmission .....	195
Industrial 2 of 5 Length Control .....	195
Industrial 2 of 5 Set Length 1 .....	196
Industrial 2 of 5 Set Length 2 .....	197
<b>IATA .....</b>	<b>198</b>
IATA Enable/Disable .....	198
IATA Check Character Transmission .....	198
<b>ISBT 128 .....</b>	<b>199</b>
ISBT 128 Concatenation .....	199
ISBT 128 Concatenation Mode .....	199
ISBT 128 Dynamic Concatenation Timeout .....	200
ISBT 128 Force Concatenation .....	201
ISBT 128 Advanced Concatenation Options .....	201
<b>MSI .....</b>	<b>202</b>
MSI Enable/Disable .....	202
MSI Check Character Calculation .....	202
MSI Check Character Transmission .....	203
MSI Length Control .....	203
MSI Set Length 1 .....	204
MSI Set Length 2 .....	205
<b>Code 93 .....</b>	<b>206</b>
Code 93 Enable/Disable .....	206
Code 93 Check Character Calculation .....	206
Code 93 Check Character Transmission .....	207
Code 93 Length Control .....	207
Code 93 Set Length 1 .....	208
Code 93 Set Length 2 .....	209
Code 93 Quiet Zones .....	210
<b>Follett 2 of 5 .....</b>	<b>211</b>
Follett 2 of 5 Enable/Disable .....	211
<b>BC412 .....</b>	<b>211</b>
BC412 Enable/Disable .....	211
BC412 Check Character Calculation .....	212
BC412 Length Control .....	212
BC412 Set Length 1 .....	213
BC412 Set Length 2 .....	214
<b>2D SYMBOLOGIES 215</b>	
<b>2D Global Features .....</b>	<b>215</b>

2D Maximum Decoding Time .....	216
2D Structured Append .....	217
2D Normal/Inverse Symbol Control .....	217
<b>SYMBOLGY SELECTION 218</b>	
<b>Aztec Code .....</b>	<b>218</b>
Aztec Code Enable / Disable .....	218
Aztec Code Length Control .....	218
<b>China Sensible Code .....</b>	<b>221</b>
China Sensible Code Enable / Disable .....	221
China Sensible Code Length Control .....	221
<b>Data Matrix .....</b>	<b>224</b>
Data Matrix Enable / Disable .....	224
Data Matrix Square/Rectangular Style .....	224
Data Matrix Length Control .....	225
<b>Maxicode .....</b>	<b>227</b>
Maxicode Enable / Disable .....	227
Maxicode Primary Message Transmission .....	227
Maxicode Length Control .....	228
<b>PDF417 .....</b>	<b>230</b>
PDF417 Enable / Disable .....	230
PDF417 Length Control .....	230
<b>Micro PDF417 .....</b>	<b>233</b>
Micro PDF417 Enable / Disable .....	233
Micro PDF417 Code 128 GS1-128 Emulation .....	233
Micro PDF417 Length Control .....	234
<b>QR Code .....</b>	<b>236</b>
QR Code Enable / Disable .....	236
QR Code Length Control .....	236
<b>Micro QR Code .....</b>	<b>239</b>
Micro QR Code Enable/Disable .....	239
Micro QR Code Length Control .....	239
<b>UCC Composite .....</b>	<b>242</b>
UCC Optional Composite Timer .....	242
<b>Postal Code Selection .....</b>	<b>243</b>
Postnet BB Control .....	244
<b>BATTERY PROFILES 245</b>	
<b>MOTION FEATURES 246</b>	
Motion Aiming Control .....	246
Motion Sensitivity .....	246
Motionless Timeout .....	247
<b>WIRELESS FEATURES 249</b>	
<b>Wireless Beeper Features .....</b>	<b>250</b>
<b>Configuration Updates .....</b>	<b>255</b>
<b>Batch Features .....</b>	<b>256</b>
<b>Direct Radio Autolink .....</b>	<b>259</b>
<b>Bluetooth-Only Features .....</b>	<b>260</b>
<b>RF Address Stamping .....</b>	<b>260</b>
<b>BT Security Features .....</b>	<b>262</b>
<b>Other BT Features .....</b>	<b>264</b>
Power Off .....	269
<b>Features for Star Models only .....</b>	<b>270</b>
<b>REFERENCES.....</b>	<b>273</b>
<b>RS-232 Parameters .....</b>	<b>274</b>
RS-232 Only .....	274
RS-232/USB COM Parameters .....	275
<b>Keyboard Interface .....</b>	<b>282</b>
Wedge Quiet Interval .....	282
Intercharacter Delay .....	283
Intercode Delay .....	284
<b>Data Format .....</b>	<b>285</b>
Data Editing .....	285



Global Prefix/Suffix .....	286
Global AIM ID .....	287
Label ID .....	288
Character Conversion .....	292
<b>Scanning Features .....</b>	<b>293</b>
Good Read LED Duration .....	293
Scan Mode .....	294
Scanning Active Time .....	295
Aiming Duration Time .....	296
Flash On Time .....	297
Flash Off Time .....	298
<b>RF Features .....</b>	<b>299</b>
Automatic Configuration Update .....	299
RF Address Stamping .....	299
STAR Radio Protocol Timeout .....	300
BT-Only Features .....	301
<b>Symbologies .....</b>	<b>302</b>
Set Length .....	302
<b>MESSAGE FORMATTING .....</b>	<b>305</b>
<b>Message Formatting .....</b>	<b>305</b>
LED and Beeper Control .....	306
<b>TECHNICAL SPECIFICATIONS.....</b>	<b>307</b>
LED and Beeper Indications .....	312
User Indications for GD4500 .....	312
User Indications GBT/GM4500 (Gun Only) .....	313
User Indications GBT/GM4500 (Cradle Only) .....	315
Programming Mode .....	316
Troubleshooting .....	316
Standard Cable Pinouts .....	317
<b>STANDARD DEFAULTS .....</b>	<b>319</b>
Default Exceptions .....	327
<b>SAMPLE BAR CODES .....</b>	<b>331</b>
<b>KEYPAD.....</b>	<b>335</b>
<b>SCANCODE TABLES.....</b>	<b>337</b>
Control Character Emulation .....	337
Single Press and Release Keys .....	337
Interface Type PC AT PS/2 or USB-Keyboards .....	338
Interface Type PC AT PS/2 Alt Mode or USB-Keyboards Alt Mode .....	340
Microsoft Windows Codepage 1252 .....	342

---

# NOTES



# Chapter 1

## Introduction

### About this Manual

This Product Reference Guide (PRG) is provided for users seeking advanced technical information, including connection, programming, maintenance and specifications. The Quick Reference Guide (QRG) and other publications associated with this product are downloadable free of charge from the website listed on the back cover of this manual.

Typically, units are factory-programmed for the most common terminal and communications settings. If you need to modify any programmable settings, custom configuration can be accomplished by scanning the programming bar codes within this guide.

Programming can alternatively be performed using the Datalogic Aladdin™ Configuration application, which is available from the Datalogic website listed on the back cover of this manual. This multi-platform utility program allows device configuration using a PC. It communicates to the device using a serial or USB cable and can also create configuration bar codes to print.

### Overview

[Chapter 1, Introduction](#) provides a product overview, unpacking instructions, and cable connection information.

[Chapter 2, Setup](#) presents information about unpacking and setting up the scanner, and interface configuration bar codes and details.

[Chapter 3, Configuration Using Bar Codes](#) provides instructions and bar code labels for customizing your scanner. There are different sections for interface types, general features, data formatting, and symbology-specific features.

[Chapter 4, References](#) provides details concerning programmable features.

[Appendix A, Technical Specifications](#) lists physical and performance characteristics, as well as environmental and regulatory specifications. It also provides standard cable pin-outs and descriptions of the functions and behaviors of the scanner's LED and Speaker indicators.

[Appendix B](#), references common factory default settings for scanner features and options.

[Appendix C, Sample Bar Codes](#) offers sample bar codes of several common symbologies.

[Appendix D, Keypad](#) includes numeric bar codes to be scanned for certain parameter settings.

[Appendix E, Scancode Tables](#) lists control character emulation information for Wedge and USB Keyboard interfaces.

## Manual Conventions

The symbols listed below are used in this manual to notify the reader of key issues or procedures that must be observed when using the scanner:



NOTE

Notes contain information necessary for properly diagnosing, repairing and operating the scanner.



CAUTION

The CAUTION symbol advises you of actions that could damage equipment or property.

## Technical Support

### Datalogic Website Support

The Datalogic website ([www.datalogic.com](http://www.datalogic.com)) is the complete source for technical support and information for Datalogic products. The site offers product support, warranty information, product manuals, product tech notes, software updates, demos, and instructions for returning products for repair.

### Reseller Technical Support

An excellent source for technical assistance and information is an authorized Datalogic reseller. A reseller is acquainted with specific types of businesses, application software, and computer systems and can provide individualized assistance.

### Telephone Technical Support

If you do not have internet or email access, you may contact Datalogic technical support at (541) 349-8283 or check the back cover of your manual for more contact information.

**Current versions of the Product Reference Guide (PRG), Quick Reference Guide (QRG), the Datalogic Aladdin™ Configuration application, software/firmware and any additional manuals, instruction sheets and utilities for this product can be downloaded from the website listed on the back cover of this manual. Alternatively, printed copies or product support CDs may be purchased through your Datalogic reseller.**

## About the Scanner

With rich feature sets and extensive model options, the Gryphon™ product series from Datalogic represents the premium level of data collection equipment for general purpose applications. The Gryphon I GD4500 reader has enhanced Megapixel optics with improved motion tolerance, allowing codes placed on fast-moving objects to be easily and quickly captured, creating the ideal reader for tasks requiring high throughput like those found in retail, light industrial environments and healthcare.

## Using the GD4500 Reader

To read a symbol or capture an image, simply aim the reader and pull the trigger. The Gryphon™ I GD4500 is a powerful omni-directional reader, so the orientation of the symbol is not important. Datalogic's exclusive patented 'Green Spot' for good-read feedback helps to improve productivity in noisy environments or in situations where silence is required. When positioning the product into the stand, the magnetic coupling will make the scanner automatically detect a bar code inside the field of view, and switch the reading system from trigger mode to autosense mode.

The Gryphon™ I GD4500 reliably decodes all standard 1D (linear) and 2D bar codes, including GS1 DataBar™ linear codes, Postal Codes (China Post), Stacked Codes (such as GS1 DataBar Expanded Stacked, GS1 DataBar Stacked, GS1 DataBar, Stacked Omnidirectional). The data stream - acquired from decoding a symbol - is rapidly sent to the host. The reader is immediately available to read another symbol.

**Figure 1. Correct positioning of scanner**

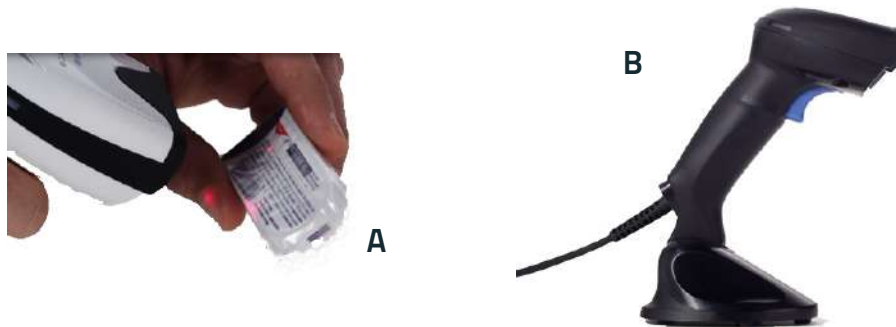

## Using the WLC4090 Radio Base

### Radio Base LEDs

LEDs on the Gryphon Base provide information about the Base as well as battery charging status, as shown in Figure 2

**Figure 2 - Gryphon Base LEDs**



**Table 1 - Radio Base LEDs**

	LED	STATUS
1	Power on / Data	Green On = Base is powered Green Blinking = Base receives data and commands from the Host or the Reader
2	Charging	Green ON = the battery is completely charged Green fading = battery level 51 to 99% Amber fading = battery level 1 to 50% Red fading = pre-charge

The button can be used to force device connection via the Datalogic Aladdin Software tool and for paging the scanner when it is activated. Refer to the Gryphon I GBT/GM4500 Product Reference Guide (PRG) for a more detailed explanation.

## Battery Safety

To install, charge and/or perform any other action on the battery, follow the instructions in this manual.



WARNING

Do not discharge the battery using any device except for the scanner. When the battery is used in devices other than the designated product, it may damage the battery or reduce its life expectancy. If the device causes an abnormal current to flow, it may cause the battery to become hot, explode or ignite and cause serious injury.

Lithium-ion battery packs may get hot, explode or ignite and cause serious injury if exposed to abusive conditions. Be sure to follow the safety warnings listed on the following page.



WARNING

- Do not place the battery pack in fire or heat.
- Do not connect the positive terminal and negative terminal of the battery pack to each other with any metal object (such as wire).
- Do not carry or store the battery pack together with metal objects.
- Do not pierce the battery pack with nails, strike it with a hammer, step on it or otherwise subject it to strong impacts or shocks.
- Do not solder directly onto the battery pack.
- Do not expose the battery pack to liquids, or allow the battery to get wet.
- Do not apply voltages to the battery pack contacts.



WARNING

In the event the battery pack leaks and the fluid gets into your eye, do not rub the eye. Rinse well with water and immediately seek medical care. If left untreated, the battery fluid could cause damage to the eye



CAUTION

Always charge the battery at 32° – 104° F (0° - 40° C) temperature range. Use only the authorized power supplies, battery pack, chargers, and docks supplied by your Datalogic reseller. The use of any other power supplies can damage the device and void your warranty.

Do not disassemble or modify the battery. The battery contains safety and protection devices, which, if damaged, may cause the battery to generate heat, explode or ignite.



CAUTION

Do not place the battery in or near fire, on stoves or other high temperature locations.

Do not place the battery in direct sunlight, or use or store the battery inside cars in hot weather. Doing so may cause the battery to generate heat, explode or ignite. Using the battery in this manner may also result in a loss of performance and a shortened life expectancy.



CAUTION

Do not place the battery in microwave ovens, high-pressure containers or on induction cookware.

Immediately discontinue use of the battery if, while using, charging or storing the battery, the battery emits an unusual smell, feels hot, changes color or shape, or appears abnormal in any other way.

Do not replace the battery pack when the device is turned on.

Do not remove or damage the battery pack's label.

Do not use the battery pack if it is damaged in any part.

Battery pack usage by children should be supervised.

As with other battery types, Lithium-Ion (LI) batteries will lose capacity over time. Capacity deterioration is noticeable after one year of service whether the battery is in use or not. It is difficult to precisely predict the finite life of a LI battery, but cell manufacturers rate them at 500 charge cycles. In other words, the batteries should be expected to take 500 full discharge/charge cycles before needing replacement. This number is higher if partial discharging/recharging is adhered to rather than full/deep discharging



**Storage of batteries for long time at fully charged status or at fully discharged status should be avoided.**



**Only in case of long storage, to avoid deep discharge of the battery it is recommended to partially recharge the battery every three months to keep the charge status at a medium level.**

**As a reference, run a fast recharge for 20 minutes every three months on unused products to avoid any performance deterioration of the cell.**

The useful life of LI batteries depends on usage and number of charges, etc., after which they should be removed from service, especially in mission critical applications. Do not continue to use a battery showing excessive loss of capacity, it should be properly recycled / disposed of and replaced.

Collect and recycle waste batteries separately from the device to comply with European Directive 2006/66/EC, 2011/65/EU, 2002/96/EC and 2012/19/EU and subsequent modifications, US and China regulatory and other laws and regulations about the environment.



---

# Programming the Reader

## Configuration Methods

### Programming Bar Codes

The reader is factory-configured with a standard set of default features. After scanning the interface bar code, you can select other options and customize your reader through use of the instructions and programming bar code labels available in the corresponding features section for your interface. Customizable settings for many features are found in "Configuration Parameters" starting on page 33.

Some programming labels, like "Restore Custom Defaults" on page 27, require only the scan of the single label to enact the change. Most, however, require the reader to be placed in Programming Mode prior to scanning them. Scan an ENTER/EXIT bar code once to enter Programming Mode. Once the reader is in Programming Mode, scan a number of parameter settings before scanning the ENTER/EXIT bar code a second time, which will then accept your changes, exit Programming Mode and return the reader to normal operation.



There are some exceptions to the typical programming sequence described above. Please read the description and setting instructions carefully when configuring each programmable feature.

### Datalogic Aladdin™

Datalogic Aladdin™ is a multi-platform utility program providing a quick and user-friendly configuration method via the RS-232/USB-COM interface. Aladdin is available on the CD-ROM provided with your product, and also from the Datalogic website. Aladdin allows you to program the reader by selecting configuration commands through a user-friendly graphical interface running on a PC. These commands are sent to the reader over the selected communication interface, or they can be printed as bar codes to be scanned.

Aladdin also provides the ability to perform a software upgrade for the connected device (see the Datalogic Aladdin™ Help On-Line for more details).

# NOTES



# Chapter 2 Setup

## Unpacking

Check carefully to ensure the scanner and any cables or accessories ordered are present and undamaged. If any damage occurred during shipment, contact Technical Support on page 2.

KEEP THE PACKAGING. Should the unit ever require service, it should be returned in its original shipping container.

## Setting Up the Scanner

Depending on whether you are using a Corded or Wireless version of the Gryphon, follow the steps provided in this section to connect and get your scanner up and communicating with its host:

1. Connect the Interface Cable to the scanner or to the Base Station as shown in Figure 3. To disconnect the cable, insert a paper clip or similar object into the opening shown.
2. Connect the other end to the Host (see the next section, [Connect Host Interface on page 10](#) and Figure 4).
3. Modify "[Customizing Configuration Settings](#)" on page 34 (only if modifications are needed from factory settings).



### NOTE

According to Regulation for shipping Li-Ion based battery packs, the products and their spare battery packs parts are shipped with a very low residual charge (low state of charge).

Hence the needs:

- that a new product must be fully recharged before starting to use it and
- that battery packs of the stocked products GBT/GM45 and spare battery pack parts must be periodically recharged : for instance by using a WLC4090 cradle powered up with a 12V Datalogic AC/DC adapter (cod. 8-0935) for at least 30 minutes each 3 months.

## Connect Host Interface

The scanner kit you ordered to match your interface should provide a compatible cable for your installation. If this is not so, contact [Technical Support](#).

The scanner can communicate using the interfaces illustrated below.

For corded versions, connect the reader cable by inserting the cable into the handle as shown in the following Figure. To remove it, insert a paper clip into the release aperture, then unplug the cable.

**Figure 3. Cable Connection/Disconnection at the Scanner**

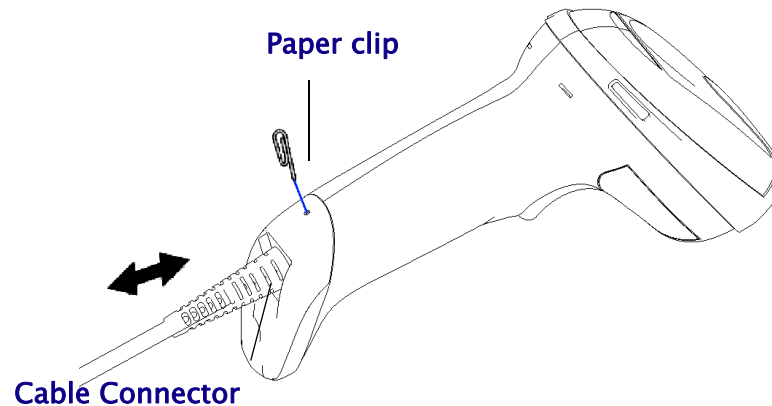

### RS-232 Serial Connection

Turn off power to the terminal/PC and connect the scanner to the terminal/PC serial port via the RS-232 cable as shown in Figure 4. If the terminal will not support POT (Power Off the Terminal) to supply scanner power, use the approved power supply (AC Adapter). Plug the AC Adapter barrel connector into the socket on the RS-232 cable connector and the AC Adapter plug into a standard power outlet.

**RS-232:** The scanner can communicate with a standard or Wincor-Nixdorf (W-N) RS-232 host.

**RS-232 OPOS:** This interface is used for OPOS/UPOS/JavaPOS systems.

### Keyboard Wedge Connection

The Keyboard Wedge cable has a 'Y' connection from the scanner. Connect the female to the male end from the keyboard and the remaining end at the keyboard port at the terminal/PC.

**Keyboard Wedge (KBW):** When connected using this interface, the host interprets scanned data as keystrokes and supports several international keyboards (for the Windows® environment). See "[Country Mode](#)" on page 56 for a full listing.

### USB Connection

Connect the scanner to a USB port on the terminal/PC using the correct USB cable for the interface type you ordered.

**USB:** Select to communicate either by USB OEM, USB COM STD, or USB Keyboard interface types by scanning the appropriate interface type bar codes available in this manual. The default interface is USB-KBD, or RS-232-STD.

Figure 4. Connection to the Host

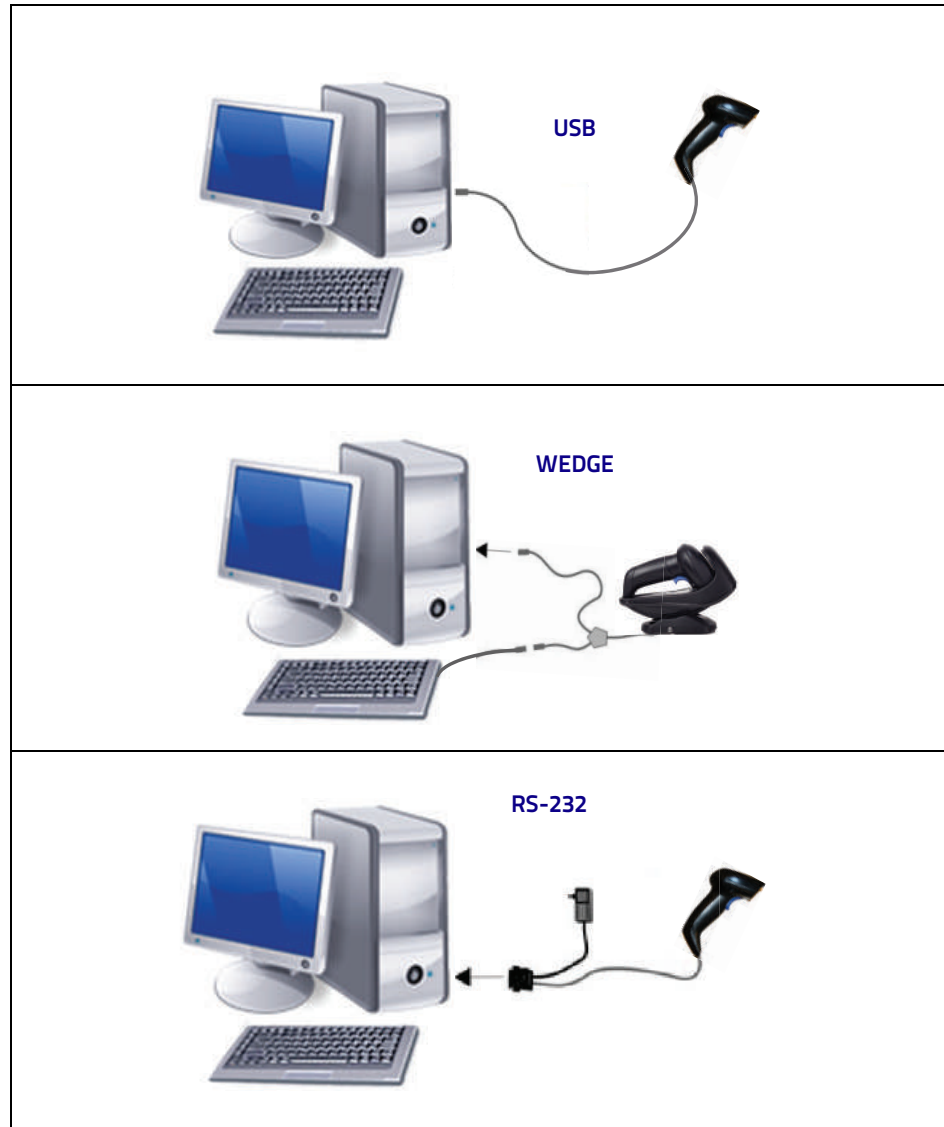
**NOTE**

Specific cables are required for connection to different hosts. The connections illustrated in Figure 4 are examples only. Actual connectors may vary from those illustrated, but the steps to connect the scanner remain the same.

## Stand Installation

### Hands-Free Stand/Holder

An accessory is available which holds the reader (except those with integrated stand) at a convenient angle, allowing hands free scanning of items.

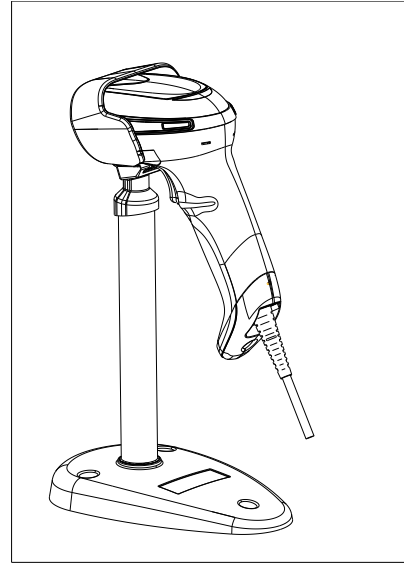
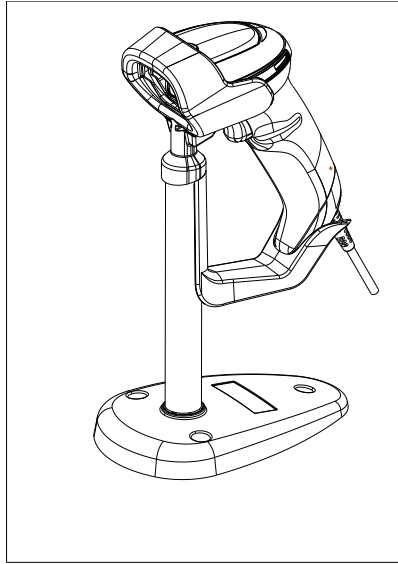

It can also be used as a holder. The holder “cup” can be positioned in any of the angles shown in the figure below. The reader automatically recognizes the insertion and changes its Scan Mode to allow the user to operate in hands-free mode.

**Figure 5. Adjusting the Stand Arm**

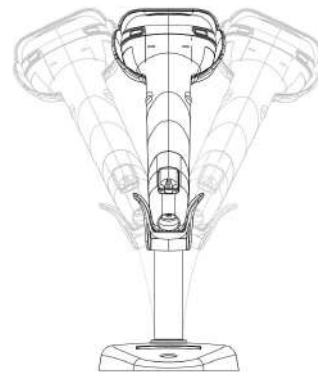
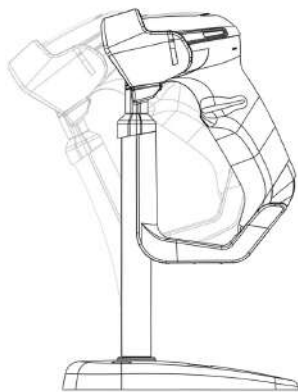

## Setting Up the Reader

Follow the steps below to connect and get your reader up and communicating with its host.

1. Configure the Base Station starting on page 18.
2. Link to the Base Station on page 28.
3. Select the Interface Type on page 30.



### NOTE

According to recent modification of Regulation for shipping Li-Ion based battery packs, the products and their spare battery packs parts are shipped with a very low residual charge (low state of charge).

Hence the needs

\* that a new product must be fully recharged before starting to use it.

and

\* that battery packs of the stocked products GBT/GM45 and spare battery pack parts must be periodically recharged: for instance by using a WLC4090 cradle powered up with a 12V Datalogic AC/DC adapter (cod.8-0935) for at least 30 minutes each 3 months.

## Positioning the Base Station

The base station/charger may be set up in desk application to hold the reader in three different positions, either a horizontal or standing or vertical position, in order to provide the most comfortable use depending on the needs.

### Base Station Positions and related clips to be used

**Figure 6 - Horizontal Position**



This position is preferred, unless a different specific positioning is required, for its utmost ease of insertion as well as the minimum effort and attention required to customer when docking the scanner.

**Figure 7 - Presentation Position**



This position is preferred if the scanner is to be used in stand mode and not needed to be often removed from base station.



**Figure 8 - Vertical Position**

This position is preferred when lack of room on the desktop recommends the scanner to be left vertical during recharging.

1. Insert the appropriate parts for the desired base station position.
2. Release the screw situated on the bottom of the cradle's base (the screw will be kept in position by the blue ring).

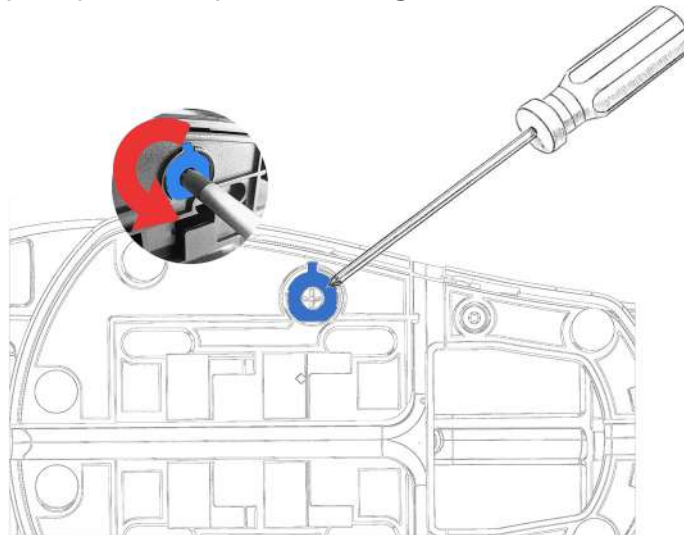

- Using your thumbs, push open the plastic tabs on the bottom of the base to free the wing holders.



- The stand can now be repositioned in either horizontal or standing position.



**NOTE**

To improve the robustness (against accidental falls) of the cradle in Presentation Position, it is suggested to add the Shock Absorber addendum as illustrated below.

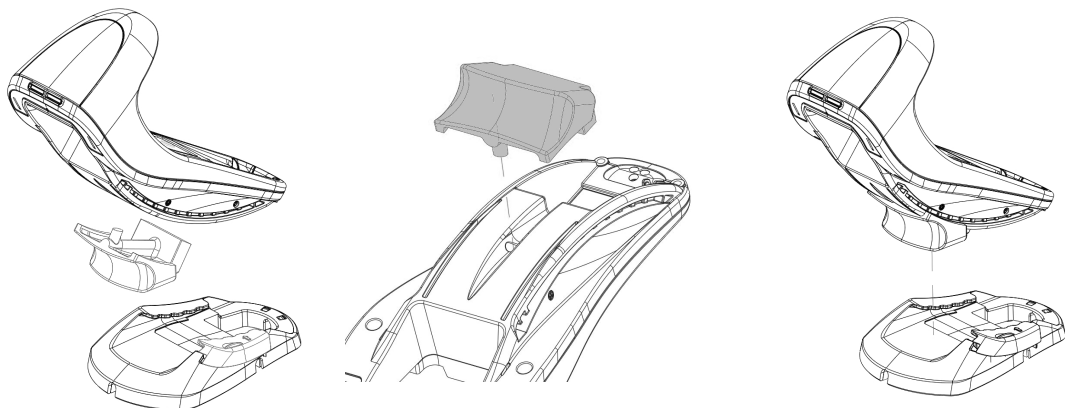

## Reader, Cradle and LEDs Description

LEDs on the gun provide information about the battery charging status as well as data transmission.

**Figure 9- Gryphon Base LEDs**

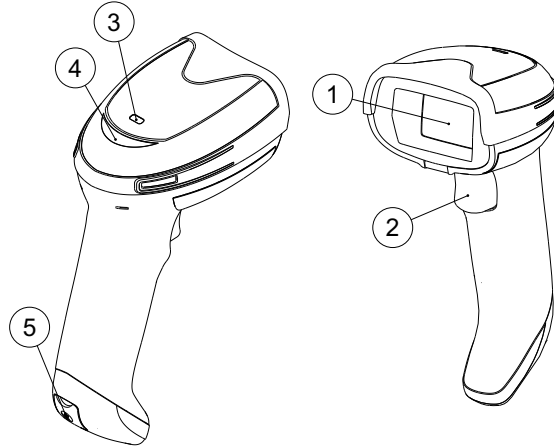

- |   |                        |   |               |
|---|------------------------|---|---------------|
| 1 | Scan Window            | 4 | Good Read LED |
| 2 | Trigger                | 5 | USB Port      |
| 3 | Battery & Recharge LED |   |               |

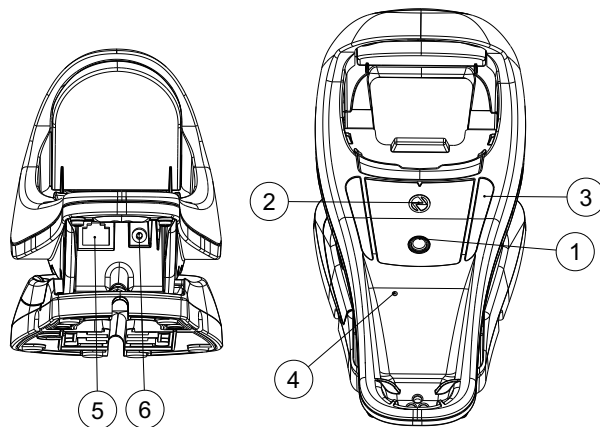

- |   |                |   |                    |
|---|----------------|---|--------------------|
| 1 | Service Button | 4 | Cable Release Hole |
| 2 | Power LED      | 5 | Communication Port |
| 3 | Recharge LED   | 6 | Aux Power Port     |

## Connecting the Base Station

The following figure shows how to connect the Base Station to a terminal, PC or other host device. Turn off the host before connection and consult the manual for that equipment (if necessary) before proceeding. Connect the interface cable before applying power to the Base Station.



### NOTE

The Gryphon GBT/GM4500 can also be Powered by the Terminal. When powered by the Terminal, the battery charger is automatically set as Slow charge.

For some specific interfaces or hosts or lengths of cable, the use of an external power supply is recommended for full recharging capability (see "Technical Specifications" on page 39 for more details).

### Base Station Connection and Routing

Fully insert the Power Cable and Interface (I/F) Cable connectors into their respective ports in the underside of the Base Station. Then connect to an AC Adapter, and plug the AC power cord into the (wall) outlet.

Figure 10 - Connecting the Base Station

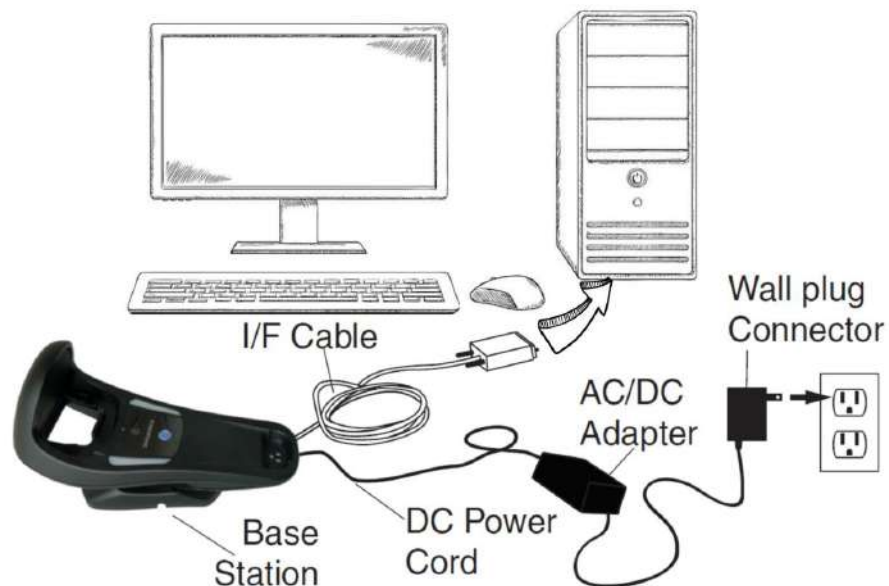

## Securing the DC Power Cord (Optional)

The DC power cord for the adapter can be secured to the bottom of the base in order to maximize the mechanical retention of the cable itself. The routing of the power cord can be changed to accommodate base station positioning: horizontal, stand or wall mount. The cables can be looped around to the front of the Base Station, or fed directly out the back of the Base Station, as shown in the figure below.

**Figure 11 - Options for routing the DC cord**



### Host Connection

Verify before connection that the reader's cable type is compatible with your host equipment.

Most connections plug directly into the host device as shown in the figure below. Keyboard Wedge interface cables have a 'Y' connection where its female end mates with the male end of the cable from the keyboard and the remaining end at the keyboard port on the terminal/PC.

**Figure 12 - Connecting to the Host**



### Power Connection

Plug the AC Adapter into an approved AC wall socket with the cable facing downwards (as shown in Figure 5) to prevent undue strain on the socket.

### Disconnecting the Cable

To detach the cable, insert a paper clip or similar object into the hole on the base, as shown.

**Figure 13 - Disconnecting the Cable**



# System and Network Layouts

## Stand Alone Layouts

Figure 14 - Single Reader Layout

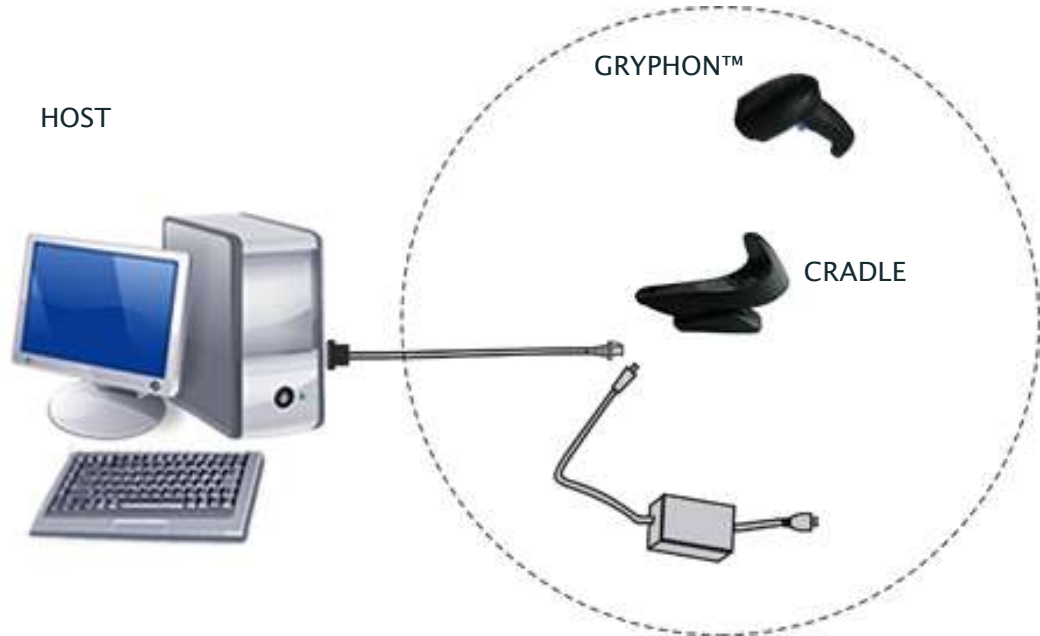
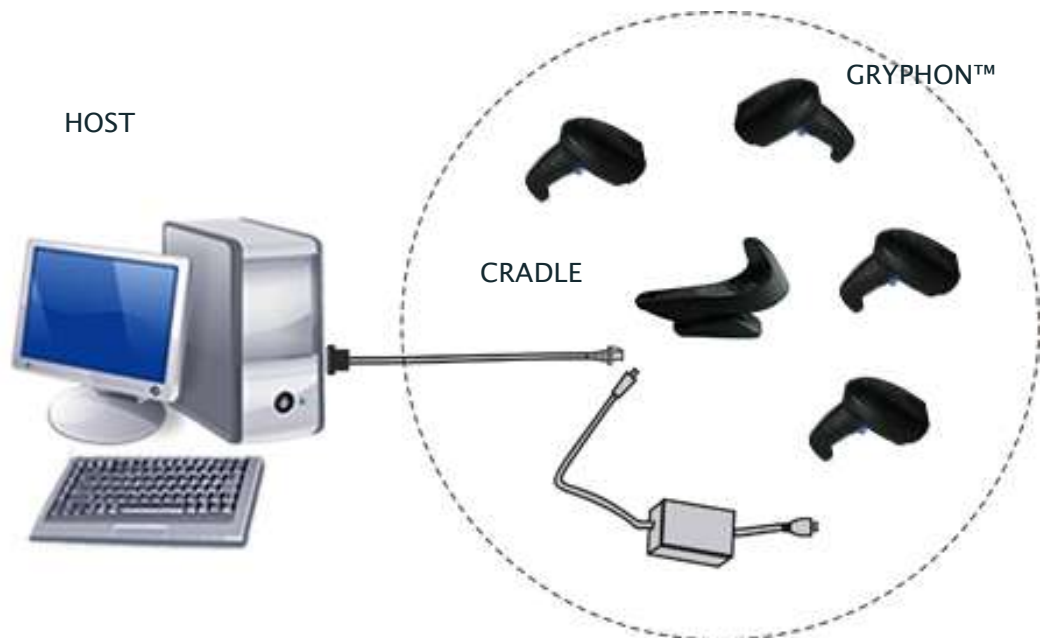
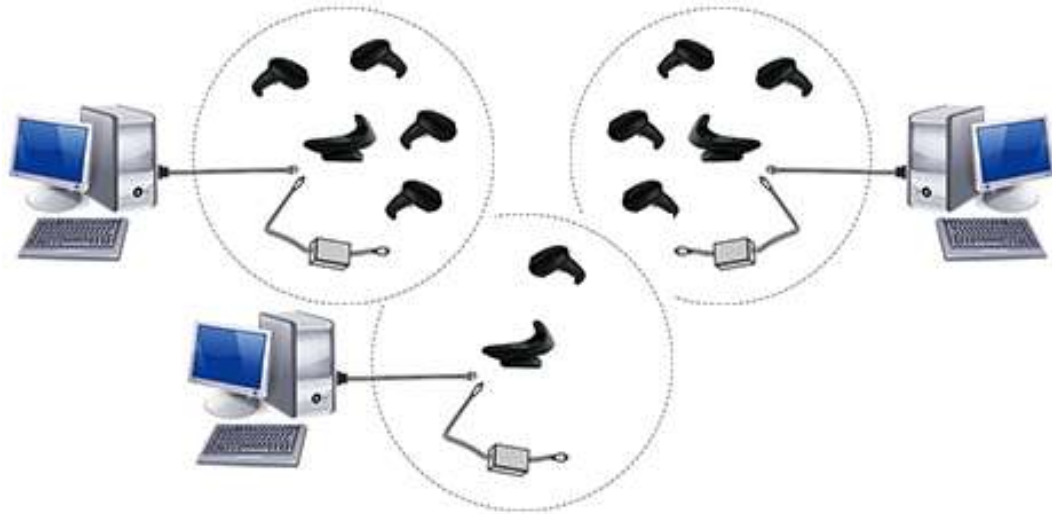

Figure 15 - Multiple Reader Layout



In stand alone systems, each cradle is connected to a single Host.

Figure 16 - Multiple Stand Alone Layouts



Many stand alone connections can operate in the same physical area without interference, provided all readers and cradles in the system have different addresses.

## Using the GBT/GM4500 Scanner

### Scanner LEDs

Specific LEDs on the Gryphon Scanner provide information about: good reading result (3GL), battery status and charging status (with micro USB only). The Battery Status information can be easily retrieved by double-tapping with your fingers on top of the head of the scanner. The following table explains the main colors' combinations provided by the Battery Status LED.

Table 2 - Battery LED

COLOR		STATUS
Blinking color (1s ON – 1s OFF)	Green (charge = 50% - 99%) Red (charge less than 1%) <b>NOTE:</b> Scanner is unusable until 1% is reached	Charge in Progress through micro USB
Solid Green (charge = 100%)	It goes <b>OFF</b> when Scanner's unplugged	Charge Complete through micro USB
Solid color (3s time-out)	Green (charge = 50% - 100%) Amber (charge = 2% - 50%) Red blinking (charge less than 2%)	Battery Status



# Using the WLC4090 Radio Base

## Radio Base LEDs

LEDs on the Gryphon Base provide information about the Base as well as battery charging status, as shown in the figure below.

Figure 17 - Gryphon Base LEDs



Table 3 - Radio Base LEDs

LED		STATUS
1	Power on / Data	Green On = Base is powered Green Blinking = Base receives data and commands from the Host or the Reader.
2	Charging	Green ON = the battery is completely charged Green fading = battery level 51 to 99% Amber fading = battery level 1 to 50% Red fading = pre-charge

The button can be used to force device connection via the Datalogic Aladdin Software tool and for paging the scanner when it is activated. Refer to the Gryphon I GBT/GM4500 Product Reference Guide (PRG) for a more detailed explanation.

## Replacing the Battery Pack



Before proceeding, read "Battery Safety" on the preceding pages. Datalogic recommends annual replacement of rechargeable battery packs to ensure maximum performance.

### NOTE

Use the following procedure to change the reader's battery:

1. With a narrow metallic object (i.e. a coin) or a screwdriver, unscrew the battery cover screw.



2. Extract the battery pack from its slot.



3. Insert the new battery in the same position.



4. Replace the battery holder cap, plug in the connector and return the contacts circuit to its previous location.



**When inserting the new battery into the handle, take care to position the battery and the connector as described above.**

**NOTE**

5. Insert the cover in the handle and screw it into place.



## Using the Gryphon™ I GD/GBT/GM4500

The Gryphon™ I GD4500 normally functions by capturing and decoding codes. The aiming system is activated on trigger pull and indicates the center of the field of view which should be positioned over the bar code:

### Aiming System

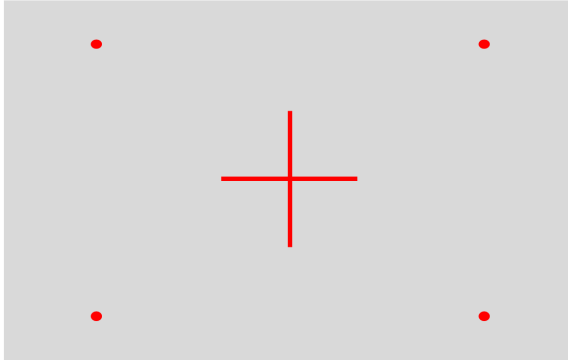

### Relative Size and Location of Aiming System Pattern

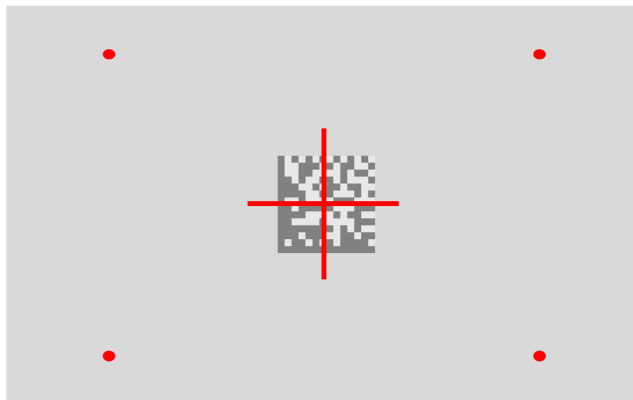

2D Matrix Symbol

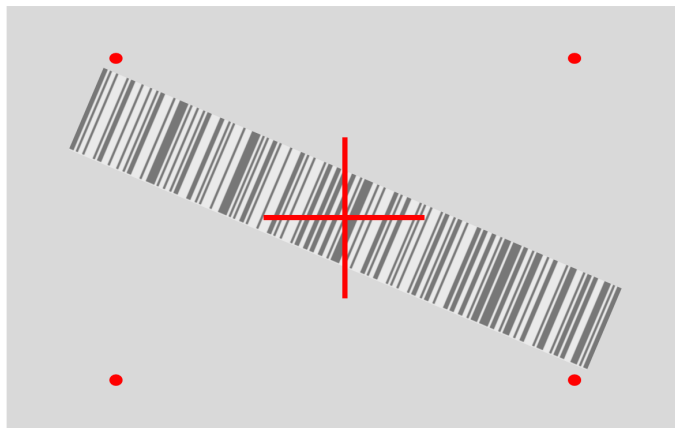

Linear Bar

A red beam illuminates the label. The field of view indicated by the aiming system will be smaller when the reader is closer to the bar code and larger when it is farther from the code. Symbologies with smaller bars or elements (mil size) should be read closer to the unit. Symbologies with larger bars or elements (mil size) should be read farther from the unit. If the aiming system is centered and the entire bar code is within the aiming field, you will get a good read. Successful reading is signaled by an audible tone plus a good-read green spot LED indicator.

### Relative Size and Location of Green Spot

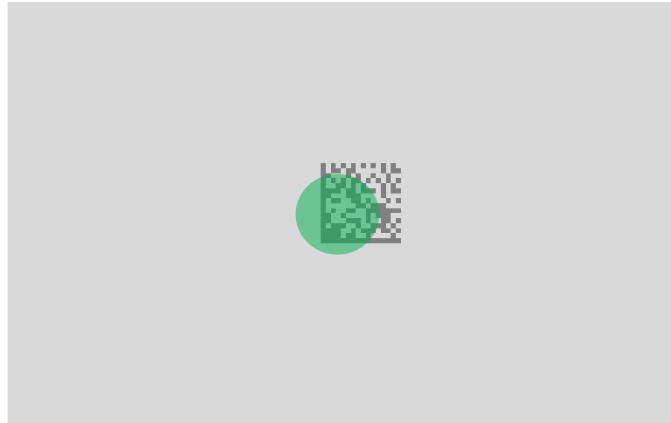

## Linking the Reader

### Link Datalogic Devices to Base

Before configuring the interface it is necessary to link the handheld with the base.

To link the handheld and the base simply put it into the base. If the reader was previously linked to another base, you must first scan the Unlink bar code before re-linking to the new base.

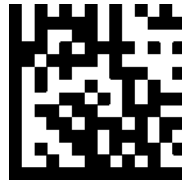

Unlink

### Link Scanner as Serial Device to a Bluetooth Host

Use this procedure to let the scanner communicate with a Bluetooth host using the Bluetooth Serial Port Profile (SPP).

1. If using a Bluetooth adapter on the host device, install any driver provided with the adapter.
2. Scan the Link to Host in SPP mode label below to make the scanner visible to the host device.
3. Use the Bluetooth manager of the host device to “Discover new devices” and select “GBT4500...”. If you receive an error message, it may be necessary to change the security settings on either the host device or the scanner.
4. Use an RS-232 terminal program to see incoming data on the port designated by the Bluetooth manager of the host device.



Link to Host in SPP mode

---

## Link Scanner as HID device to a Bluetooth host

Use this procedure to send data to a Bluetooth host using the Bluetooth HID profile.

1. If using a Bluetooth adapter on the host device, install any driver provided with the adapter.
2. Scan the Link to Host in HID mode label below to make the scanner visible to the host device.
3. Use the Bluetooth manager of the host device to "Discover new devices" and select "GBT4500 ...". If you receive an error message, it may be necessary to change the security settings on either the host device or the scanner.
4. On the host device, open the program that is meant to receive the incoming data.

The data transmitted by the scanner will appear in the program as if it was typed using the keyboard of the host device.



Link to Host in HID mode



### NOTE

The Gryphon I GBT4500 can be set up to authenticate the remote system when connecting, by entering a Bluetooth passkey or a PIN code. If you want to set the security level and authentication options suitable for your application, or when adding new equipment to a system that requires authentication or uses a custom security PIN, please see the PRG for information.

## Power Off

Scan the bar code below to shut off power to the handheld until the next trigger pull.



PowerOff

---

## Interface Selection

Upon completing the physical connection between the scanner and its host, proceed directly to "Configuring the Interface" on page 30 for information and programming for the interface type the scanner is connected to (for example: RS-232, Keyboard Wedge, USB, etc.) and scan the appropriate bar code in that section to select your system's correct interface type.

The scanner, depending upon the model, will support one of the following sets of host interfaces:

- USB (Keyboard, COM, OEM)
- USB Composite (Keyboard + COM)
- USB HID POS
- USB Toshiba TEC
- RS-232 STD
- RS-232 WN
- RS232 OPOS
- Keyboard Wedge
- IBM46XX port 9b (a specific cable's required)
- Datalogic Magellan Scanners' specific interface

## Configuring the Interface

Scan the programming bar code from the following section which selects the appropriate interface type to match the system the scanner will be connected to. Next, proceed to the corresponding chapter in this manual (also listed in the table) to configure any desired settings and features associated with that interface.







### NOTE

Unlike some other programming features and options, interface selections require that you scan only one programming bar code label. **DO NOT** scan an ENTER/EXIT bar code prior to scanning an interface selection bar code. Some interfaces require the scanner to start in the disabled state when powered up. If additional scanner configuration is desired while in this state, pull the trigger and hold for 5 seconds. The scanner will change to a state that allows programming with bar codes.









Table 4. Available Interfaces

RS-232		FEATURES
RS-232 standard interface	 Select RS232-STD	
 Select RS232-WN	RS-232 Wincor-Nixdorf	
RS-232 for use with OPOS/UPOS/JavaPOS	 Select RS-232 OPOS	
 Select USB-COM-STD <sup>a</sup>	USB Com to simulate RS-232 standard interface	
USB-OEM		
USB-OEM (can be used for OPOS/UPOS/JavaPOS)	 Select USB-OEM	Set USB-OEM Interface Features starting on page 87

a. Download the correct USB Com driver from [www.datalogic.com](http://www.datalogic.com)

USB-COMPOSITE	FEATURES
<p>USB-Composite (combines USB-KBD emulation and USB-COM)</p>  <p>Select USB-Composite</p>	
OTHER INTERFACES	
 <p>Select IBM46xx Port 9b</p> <p>IBM46xx Port 9b</p>	
<p>USB HID POS</p>  <p>Select USB HID POS</p>	
 <p>Select USB Toshiba TEC</p> <p>USB Toshiba TEC</p>	
<p>Datalogic Magellan Scanners' specific interface</p>  <p>Select Datalogic Magellan Scanners' specific interface</p>	

KEYBOARD	FEATURES
<p>AT, PS/2 25-286, 30-286, 50, 50Z, 60, 70, 80, 90 &amp; 95 w/Standard Key Encoding</p>  <p>Select KBD-AT</p>	<p>Set KEYBOARD WEDGE Interface Features starting on page 55</p>
 <p>Select KBD-AT-NK</p> <p>Keyboard Wedge for IBM AT PS2 with standard key encoding but without external keyboard</p>	
<p>AT, PS/2 25-286, 30-286, 50, 50Z, 60, 70, 80, 90 &amp; 95 w/Alternate Key</p>  <p>Select KBD-AT-ALT</p>	
 <p>Select KBD-AT-ALT-NK</p> <p>Keyboard Wedge for IBM AT PS2 with alternate key encoding but without external keyboard</p>	
<p>USB Keyboard with standard key encoding</p>  <p>Select USB Keyboard</p>	
 <p>Select USB Alternate Keyboard</p> <p>USB Keyboard with alternate key encoding</p>	

---

## Customizing Configuration Settings

### Using the Programming Bar Codes

This manual contains feature descriptions and bar codes which allow you to reconfigure your scanner. Some programming bar code labels, like "Resetting the Product Configuration to Defaults" on page 35, require only the scan of that single label to enact the change. Most of the programming labels in this manual, however, require the scanner to be placed in Programming Mode prior to scanning them. Scan an ENTER/EXIT bar code once to enter Programming Mode. Once the scanner is in Programming Mode, you can scan a number of parameter settings before scanning the ENTER/EXIT bar code a second time, which will then accept your changes, exit Programming Mode and return the scanner to normal operation.



#### NOTE

There are some exceptions to the typical programming sequence described above. Please read the description and setting instructions carefully when configuring each given programmable feature.

### Datalogic Aladdin™ Utility

Programming can alternatively be performed using the Datalogic Aladdin™ Configuration application which is available for free download from the Datalogic website listed on the back cover of this manual. This multi-platform utility program allows device configuration using a PC. It communicates to the device using a serial or USB cable and can also create configuration bar codes to print. Datalogic Aladdin™ is a multi-platform utility program providing a quick and user-friendly configuration method via the RS-232/USB-COM interface. The Aladdin utility is available on the Datalogic website. Aladdin allows you to program the scanner by selecting configuration commands through a user-friendly graphical interface running on a PC. These commands are sent to the scanner over the selected communication interface, or they can be printed as bar codes to be scanned.

Aladdin also provides the ability to perform a software upgrade for the connected device (see the Datalogic Aladdin™ Help On-Line for more details).

## Interface Settings

The scanner is typically factory-configured with a set of default features standard to the interface type you ordered. See "Interface Selection" on page 30. [Global Interface Features, starting on page 39](#) provides settings configurable by all interface types. If your installation requires you to further customize your scanner, you can select other options through use of the instructions and programming bar codes available in the appropriate section for your interface.

- **RS-232 ONLY INTERFACE** on page 41
- **RS-232/USB-COM INTERFACES** on page 45
- RS232 OPOS on page 30
- USB Composite (COM + Keyboard) on page 30
- **KEYBOARD INTERFACE** on page 55
- **USB-OEM INTERFACE** on page 87

## Configuring Other Features

If your installation requires different programming than the standard factory default settings, the following sections of this manual allow configuration of non-interface-specific settings you might require:

**Configuration Using Bar Codes:** General Features includes programming for scanning, speaker and LED indicators and other such universal settings.

**Reading Parameters:** Reading Parameters include programming for scanning, speaker and LED indicators and other universal settings.

**1D Symbologies:** Includes options concerning the bar code label types (symbologies). These settings allow you to enable/disable symbologies, set label lengths, require check digit, etc.

## Software Version Transmission

The software version of the device can be transmitted over the RS-232, Keyboard and USB interfaces by scanning the following label.



Transmit Software Version

## Resetting the Product Configuration to Defaults

If you aren't sure what programming options are in your scanner, or you've changed some options and want to restore the Custom Default Configuration that may have been saved in the scanner, scan the [Restore Custom Default Configuration](#) bar code below. This will restore the custom configuration for the currently active interface.



**NOTE**

**Custom defaults are based on the interface type. Configure the scanner for the correct interface before scanning this label.**



Restore Custom Default Configuration

# NOTES



## Chapter 3

# Configuration Using Bar Codes

This and following sections provide programming bar codes to configure your scanner by changing the default settings. For details about additional methods of programming, see "Customizing Configuration Settings" on page 34.



**NOTE**

You must first enable your scanner to read bar codes in order to use this section. If you have not done this, go to Setup, starting on page 9 and complete the appropriate procedure.

## Configuration Parameters

Once the scanner is set up, you can change the default parameters to meet your application needs. Refer to "Resetting the Product Configuration to Defaults" on page 35 for initial configuration in order to set the default values and select the interface for your application.

The following configuration parameters are divided into logical groups, making it easy to find the desired function based on its reference group.

### Interface Configuration:

- "RS-232 ONLY Interface" on page 41
- "RS-232/USB-COM Interfaces" on page 45
- "Keyboard Interface" on page 55
- "USB-OEM Interface" on page 87

### Parameters common to all interface applications:

- "Global Prefix/Suffix" on page 76
- "Data Format" on page 93 offers advanced configuration options for customization of scanned data output.
- "Reading Parameters" on page 105 control various operating modes and indicators status functioning.

### Symbology-specific parameters:

"1D Symbologies" on page 113 defines options for all symbologies and provides the programming bar codes necessary for configuring these features.



**NOTE**

You must first enable your scanner to read bar codes in order to use this section. If you have not done this, go to Setup, starting on page 9 and complete the appropriate procedure.



**To program features:**

1. Scan the ENTER/EXIT PROGRAMMING bar code, available at the top of each programming page, when applicable.
2. Scan the bar code to set the desired programming feature. You may need to cover unused bar codes on the page, and possibly the facing page, to ensure that the scanner reads only the bar code you intend to scan.
3. If additional input parameters are needed, go to [Appendix D, Keypad](#), and scan the appropriate characters from the keypad.



**NOTE**

Additional information about many features can be found in the "References" chapter.

If you make a mistake before the last character, scan the CANCEL bar code to abort and not save the entry string. You can then start again at the beginning.

4. Complete the programming sequence by scanning the ENTER/EXIT PROGRAMMING bar code to exit Programming Mode.

For more detailed descriptions, programming information and examples for setting selected configuration items, see [References, starting on page 273](#).





## Global Interface Features

The following interface features are configurable by all interface types. To set features specific to your interface, turn to that section of this manual.

<b>HOST COMMANDS — OBEY/IGNORE on page 39</b>
<b>USB SUSPEND MODE on page 39</b>

### Host Commands — Obey/Ignore

This option specifies whether the scanner will obey or ignore host commands. When set to ignore, the scanner will ignore all host commands except for those necessary for:

- service mode
- flash programming mode
- keeping the interface active
- transmission of labels.

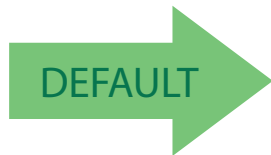

Host Commands = Obey



Host Commands = Ignore

### USB Suspend Mode

This setting enables/disables the ability of the USB interface to enter suspend mode.



USB Suspend Mode = Enable



---

# NOTES



## RS-232 ONLY Interface

Use the programming bar codes in this chapter if modifications to the standard RS-232 interface settings are necessary to meet your system's requirements. Additional settings which apply to both the RS-232 and USB interfaces are available in Chapter 5, RS-232/USB-COM Interfaces.

<b>BAUD RATE</b> on page 41	<b>PARITY</b> on page 43
<b>DATA BITS</b> on page 42	<b>HANDSHAKING CONTROL</b> on page 44
<b>DATA BITS</b> on page 42	

### RS-232 Standard Factory Settings

Reference [Appendix B](#), for a listing of standard factory settings.

#### Baud Rate

Baud rate is the number of bits of data transmitted per second. Set the scanner's baud rate to match the baud rate setting of the host device. With an improper baud rate setting, data may not reach the host correctly.



Baud Rate = 1200



Baud Rate = 2400



Baud Rate = 4800



Baud Rate = 9600





## Baud Rate (continued)



Baud Rate = 19,200



Baud Rate = 38,400



Baud Rate = 57,600



Baud Rate = 115,200

## Data Bits

This parameter allows the reader to interface with devices requiring a 7-bit or 8-bit ASCII protocol for sending and receiving data.



7 Data Bits



8 Data Bits



## Stop Bits

The stop bit(s) at the end of each transmitted character marks the end of transmission of one character and prepares the receiving device for the next character in the serial data stream. The number of stop bits selected (one or two) depends on the number the receiving terminal is programmed to accommodate. Set the number of stop bits to match host device requirements.

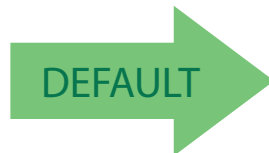

## Parity

This feature specifies parity required for sending and receiving data. A parity check bit is the most significant bit of each ASCII coded character. Select the parity type according to host device requirements.

- Select None when no parity bit is required.
- Select Odd parity and the parity bit value is set to 0 or 1, based on data, to ensure that an odd number of 1 bits are contained in the coded character.
- Select Even parity and the parity bit value is set to 0 or 1, based on data, to ensure that an even number of 1 bits are contained in the coded character.

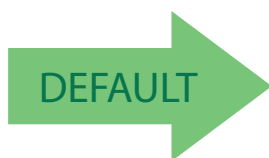



# Handshaking Control

The data interface consists of an RS-232 port designed to operate either with or without the hardware handshaking lines, Request to Send (RTS), and Clear to Send (CTS). Handshaking Control includes the following options:

- RTS — RTS is asserted during transmissions. CTS is ignored.
- RTS/CTS — RTS is asserted during transmissions. CTS gates transmissions.
- RTS/XON/XOFF — RTS is asserted during transmissions. CTS is ignored. XON and XOFF gate transmissions.
- RTS On/CTS — RTS is always asserted. CTS gates transmissions.
- RTS/CTS Scan Control — RTS is asserted during transmissions. CTS gates transmissions and controls enable and disable state of scanner.

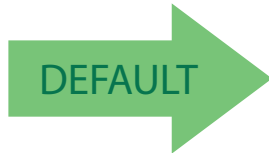

Handshaking Control = RTS



Handshaking Control = RTS/CTS



Handshaking Control = RTS/XON/XOFF



Handshaking Control = RTS On/CTS



Handshaking Control = RTS/CTS Scan Control

# RS-232/USB-COM Interfaces

The programming bar codes in this chapter allow modifications to the standard RS-232 and USB-Com interfaces.

<b>STANDARD FACTORY SETTINGS</b> on page 45
<b>INTERCHARACTER DELAY</b> on page 46
<b>BEEP ON ASCII BEL</b> on page 47
<b>BEEP ON NOT ON FILE</b> on page 47
<b>ACK NAK OPTIONS</b> on page 48
<b>ACK CHARACTER</b> on page 49
<b>NAK CHARACTER</b> on page 49
<b>ACK NAK TIMEOUT VALUE</b> on page 50
<b>ACK NAK RETRY COUNT</b> on page 51
<b>ACK NAK ERROR HANDLING</b> on page 52
<b>INDICATE TRANSMISSION FAILURE</b> on page 53
<b>DISABLE CHARACTER</b> on page 53
<b>ENABLE CHARACTER</b> on page 54

## Standard Factory Settings

Reference [Appendix B](#), for a listing of standard factory settings.



## Intercharacter Delay

This parameter specifies the intercharacter delay between the end of one character and the beginning of the next. The delay can be set within a range of zero (0) to 990 milliseconds in 10ms increments. A setting of zero specifies no delay. See "Label ID: Pre-loaded Sets" on page 288 for more detailed programming instructions.



Intercharacter Delay = No Delay



Select Intercharacter Delay Setting

To configure this feature, scan the ENTER/EXIT bar code above, then the bar code at left followed by digits from the Alphanumeric characters in [Appendix D, Keypad](#) representing your desired character(s). End by scanning the ENTER/EXIT bar code again.

Make a mistake? Scan the CANCEL bar code to abort and not save the entry string. You can then start again at the beginning.



CANCEL

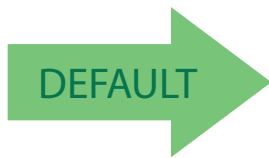

**00 = No Intercharacter Delay**



## Beep On ASCII BEL

When this parameter is enabled, the scanner issues a beep when a <BEL> character is detected on the RS-232 serial line. <BEL> is issued to gain a user's attention to an illegal entry or other important event.



## Beep On Not on File

This option enables/disables the action of the scanner to sound a three beep sequence upon receiving a Not-On-File (NOF) host command.

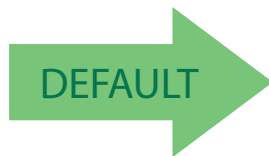



## ACK NAK Options

This enables/disables the ability of the scanner to support the RS-232 ACK/NAK protocol. When configured, the scanner and/or host sends an “ACK” when it receives data properly, and sends “NAK” when the data is in error.

Options are:

- Disable
- Enable for label transmission — The scanner expects an ACK/NAK response from the host when a label is sent.
- Enable for host-command acknowledge — The scanner will respond with ACK/NAK when the host sends a command.
- Enable for label transmission and host-command acknowledge

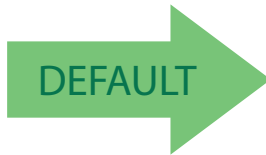

ACK/NAK Protocol = Disable ACK/NAK



ACK/NAK Protocol = Enable for label transmission



ACK/NAK Protocol = Enable for host-command acknowledge



ACK/NAK Protocol = Enable for label transmission and host-command acknowledge



## ACK Character

This setting specifies an ASCII character or hex value to be used as the ACK character. ASCII characters or any hex value from 0 to 0xFF can be selected. See "ACK Character" on page 276 for more detailed programming instructions.



NOTE

Setting to previously defined characters such as XON, XOFF, or host commands conflicts with normal operation of these characters. 8-bit data is not recognized when the option Data Bits on page 42 has been set as 7 Data Bits.



Select ACK Character Setting

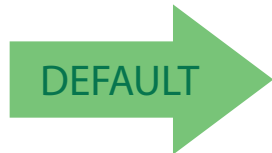

0x06 'ACK' Character

## NAK Character

This setting specifies an ASCII character or hex value to be used as the NAK character. ASCII characters or any hex value from 0 to 0xFF can be selected. See "NAK Character" on page 277 for more detailed programming instructions.



NOTE

Setting to previously defined characters such as XON, XOFF, or host commands conflicts with normal operation of these characters. 8-bit data is not recognized when the option Data Bits on page 42 has been set as 7 Data Bits.



Select NAK Character Setting

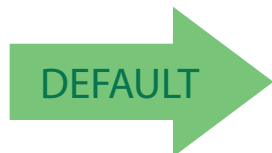

0x15 'NAK' Character

Make a mistake? Scan the CANCEL bar code to abort and not save the entry string. You can then start again at the beginning.



CANCEL



## ACK NAK Timeout Value

This option specifies the amount of time the scanner waits for an ACK character from the host following label transmission. The selectable timeout range is 200 milliseconds to 15,000ms (15 seconds) in 200ms increments. A selection of 0 disables the timeout. See "ACK NAK Timeout Value" on page 278 for more detailed programming instructions.



Select ACK NAK Timeout Value Setting

To configure this feature, scan the ENTER/EXIT bar code above, then the bar code at left followed by digits from the Alphanumeric characters in [Appendix D, Keypad](#) representing your desired character(s). End by scanning the ENTER/EXIT bar code again.

Make a mistake? Scan the CANCEL bar code to abort and not save the entry string. You can then start again at the beginning.



CANCEL

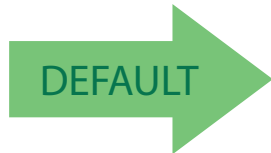

01 ACK NAK Timeout value is 200ms

## ACK NAK Retry Count

This feature specifies the number of times the scanner retries a label transmission due to a retry condition. The selectable range is from 1 to 254 retries. A selection of 0 disables the count, and a selection of 255 specifies unlimited retries. See "[ACK NAK Retry Count](#)" on page 279 for more detailed programming instructions.



Select ACK NAK Retry Count Setting

To configure this feature, scan the ENTER/EXIT bar code above, then the bar code at left followed by digits from the Alphanumeric characters in [Appendix D, Keypad](#) representing your desired character(s). End by scanning the ENTER/EXIT bar code again.

Make a mistake? Scan the CANCEL bar code to abort and not save the entry string. You can then start again at the beginning.



CANCEL





## ACK NAK Error Handling

This feature specifies the method the scanner uses to handle receive errors detected while waiting for an ACK character from the host.

Options are:

- Ignore errors detected
- Process error as valid ACK character
- Process error as valid NAK character

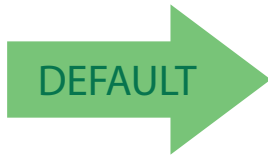

ACK NAK Error Handling = Ignore Errors Detected



ACK NAK Error Handling = Process Error as Valid ACK Character



ACK NAK Error Handling = Process Error as Valid NAK Character



## Indicate Transmission Failure

This option enables/disables the scanner's ability to sound an error beep to indicate a transmission failure while in ACK/NAK mode.



Indicate Transmission Failure = Disable Indication



Indicate Transmission Failure = Enable Indication



## Disable Character

Specifies the value of the RS-232 host command used to disable the scanner. ASCII characters or any hex value from 0 to 0xFF can be selected. See "Disable Character" on page 280 for more detailed programming instructions.



### NOTE

Setting to previously defined characters such as XON, XOFF, or host commands conflicts with normal operation of these characters.



Select Disable Character Setting

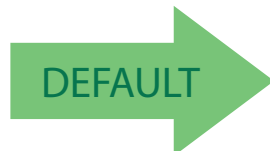

0x44 = Disable Character is 'D'

Make a mistake? Scan the CANCEL bar code to abort and not save the entry string. You can then start again at the beginning.



CANCEL



## Enable Character

Specifies the value of the RS-232 host command used to enable the scanner. ASCII characters or any hex value from 0 to 0xFF can be selected. See "Enable Character" on page 281 for more detailed programming instructions.



**NOTE**

Setting to previously defined characters such as XON, XOFF, or host commands conflicts with normal operation of these characters.



Select Enable Character Setting

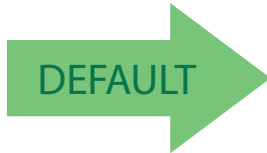

**0x45 = Enable Character is 'E'**

Make a mistake? Scan the CANCEL bar code to abort and not save the entry string. You can then start again at the beginning.

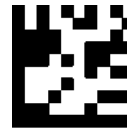

CANCEL



# Keyboard Interface

Use the programming bar codes in this chapter to select options for USB Keyboard and Wedge Interfaces. Reference [Appendix B](#), for a listing of standard factory settings. Information about control character emulation which applies to keyboard interfaces is listed in [Appendix E, Scancode Tables](#).

<b>COUNTRY MODE</b> on page 56
<b>CAPS LOCK STATE</b> on page 79
<b>NUMLOCK</b> on page 79
<b>KEYBOARD NUMERIC KEYPAD</b> on page 80
<b>KEYBOARD SEND CONTROL CHARACTERS</b> on page 81
<b>WEDGE QUIET INTERVAL</b> on page 82
<b>INTERCODE DELAY</b> on page 84
<b>USB KEYBOARD SPEED</b> on page 85



## Country Mode

This feature specifies the country/language supported by the keyboard. The Country Mode setting is ignored if the interface uses alternate key encoding.

### Setup on PC to use ALT Universal

1. Open Registry Edit

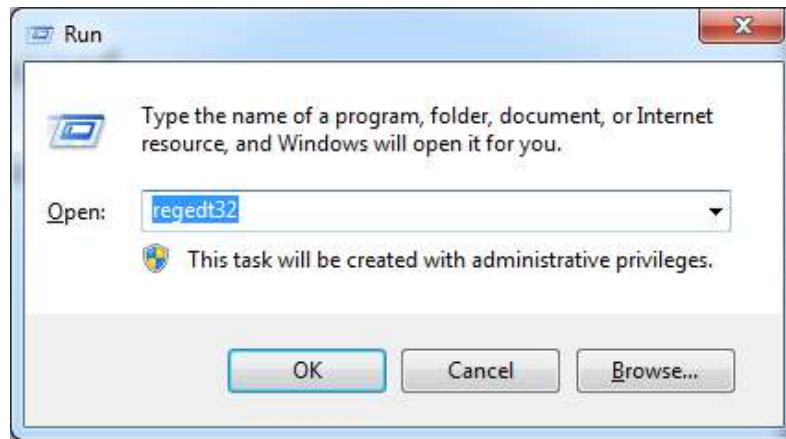

2. Set EnableHexNumpad to 1 as follows:

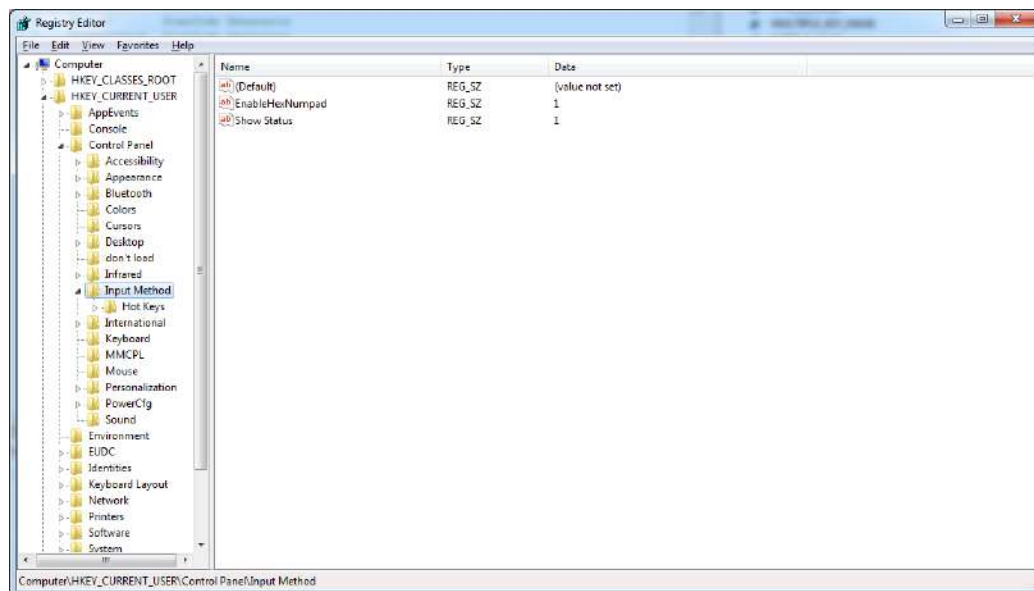

3. Reset the PC.



## Setting Country Mode

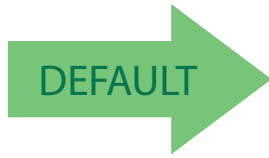

United States



French International (Belgian French)



United Kingdom



Danish



French (France)



German



Italian



---

## Setting Country Mode (continued)



Norwegian



Portuguese Portugal



Spanish



Swedish



Swiss French



Japanese ASCII



Hungarian



## Setting Country Mode (continued)



Slovak



Czech



Romanian



Croatian



Polish\_214



Canadian French Win7



Lithuanian



---

## Setting Country Mode (continued)



Vietnamese



Russian



Arabic 101



Chinese ASCII



Thai-Kedmanee



Albanian



Arabic 102



## Setting Country Mode (continued)



Arabic 102 AZERTY



Azeri Cyrillic



Azeri Latin



Belarusian



Bosnian Cyrillic



Bosnian Latin



Bulgarian Cyrillic



## Setting Country Mode (continued)



Bulgarian Latin



Canadian French (Legacy)



Canadian Multilingual



Chinese (Simplified)



Chinese (Traditional)



Czech Programmers



Czech QWERTY



## Setting Country Mode (continued)





---

### Setting Country Mode (continued)



Greek



Greek Latin



Greek Polytonic



Greek220



Greek220 Latin



Greek319



Greek319 Latin



## Setting Country Mode (continued)





## Setting Country Mode (continued)



Korean (Hangul)



Korean ASCII



Kyrgyz Cyrillic



Latin America



Latvian



Latvian QWERTY



Lithuanian\_IBM



## Setting Country Mode (continued)



Macedonian -FYROM



Maltese\_47KEY



Mongolian-Cyrillic



Polish Programmer



Portuguese Brazil



Portuguese Brazilian ABNT



Portuguese Brazilian ABNT2



## Setting Country Mode (continued)



Romanian Legacy



Romanian Programmer



Romanian Standard



Russian Typewriter



Serbian Cyrillic



Serbian Latin



Slovak QWERTY

## Setting Country Mode (continued)





---

## Setting Country Mode (continued)



US Dvorak



US Dvorak Left Hand



US Dvorak Right Hand



US English (Mac)



US English (North American)



US International



Uzbek Cyrillic





## Setting Encoding Type

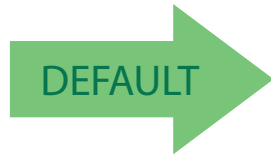

Don't use encoding



UTF\_8



Windows 874



Windows 932



Windows 936



Windows 949



Windows 950



## Setting Encoding Type (continued)



Windows 1250



Windows 1251



Windows 1252



Windows 1253



Windows 1254



Windows 1255



Windows 1256



### Setting Encoding Type (continued)



Windows 1258



Windows 1257



Windows 20866



ISO 8859-1



ISO 8859-2



ISO 8859-3



ISO 8859-4



---

### Setting Encoding Type (continued)



ISO 8859-5



ISO 8859-6



ISO 8859-7



ISO 8859-8



ISO 8859-9



ISO 8859-10



ISO 8859-11



### Setting Encoding Type (continued)



ISO 8859-13



ISO 8859-14



ISO 8859-15



ISO 8859-16



MS-DOS 437



MS-DOS 737



MS-DOS 775



---

### Setting Encoding Type (continued)



MS-DOS 850



MS-DOS 852



MS-DOS 855



MS-DOS 857



MS-DOS 860



MS-DOS 861



MS-DOS 862



## Setting Encoding Type (continued)



MS-DOS 863



MS-DOS 865



MS-DOS 866



MS-DOS 869



Mac CP10000



## Setting ALT output type

This option specifies the encode type of ALT Mode when the scanner sends Output Keyboard Data in Alt Mode. (Be aware that the scanner may switch automatically between ALT mode & Normal Keyboard Scancode, to correctly display some characters that are not present in the current Keyboard Country).

.



ALT Codepage: (use on non Unicode application: Notepad)



ALT Unicode: (use on Unicode application: Word)



DEFAULT



ALT Universal: (Use for all)



## Caps Lock State

This option specifies the format in which the scanner sends character data. This applies to Keyboard Wedge interfaces. This does not apply when an alternate key encoding keyboard is selected. This does not apply to USB Keyboard.

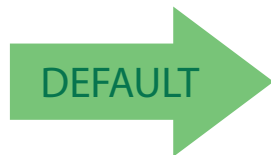

Caps Lock State = Caps Lock OFF



Caps Lock State = Caps Lock ON



Caps Lock State = AUTO Caps Lock Enable

## Numlock

This option specifies the setting of the Numbers Lock (Numlock) key while in Keyboard Wedge interface. This only applies to alternate key encoding interfaces. It does not apply to USB Keyboard.

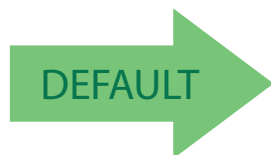

Numlock = Numlock key unchanged



Numlock = Numlock key toggled



## Keyboard Numeric Keypad

This feature specifies if numeric characters will be sent using the standard keys or the numeric keypad.

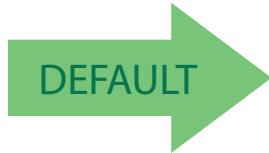

Keyboard Numeric Keypad = Standard Keys



Keyboard Numeric Keypad = Numeric Keypad



## Keyboard Send Control Characters

This feature is used by the Keyboard Wedge and USB Keyboard interfaces. It specifies how the scanner transmits ASCII control characters to the host. Reference [Appendix E, Scancode Tables](#) for more information about control characters.

Options are as follows:

**Send Ctrl+Key :** ASCII characters from 00H to 0x1FH inclusive are transmitted in the format Ctrl+Key. Special keys are available in the range from 81H to A1.

**Send Ctrl+Shift+Key :** The behavior is the same as above, but control keys are sent in the format Ctrl+Shift+Keys.

**Send Special Function Key :** Send characters between 00H and 1FH according to the special function key mapping table (see "[Interface Type PC AT PS/2 Alt Mode or USB-Keyboard Alt Mode](#)" on page 340). This is used to send keys that are not in the normal ASCII set. A unique set is provided for each available scancode set.

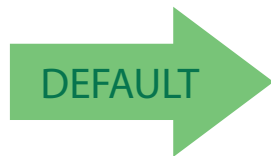

Keyboard Send Control Characters = Send Ctrl+Key



Keyboard Send Control Characters = Send Ctrl+Shift+Key



Keyboard Send Control Characters = Send Special Function Key :



## Wedge Quiet Interval

This option specifies the amount of time to look for keyboard activity before the scanner breaks the keyboard connection in order to transmit data to host. The selectable range for this feature is from 0 to 990ms in 10ms increments. See "Wedge Quiet Interval" on page 282 for more detailed programming instructions.



**NOTE**

This feature applies **ONLY** to the Keyboard Wedge interface.



Select Wedge Quiet Interval Setting

To configure this feature, scan the ENTER/EXIT bar code above, then the bar code at left followed by digits from the Alphanumeric characters in [Appendix D, Keypad](#) representing your desired character(s). End by scanning the ENTER/EXIT bar code again.

Make a mistake? Scan the CANCEL bar code to abort and not save the entry string. You can then start again at the beginning.



CANCEL

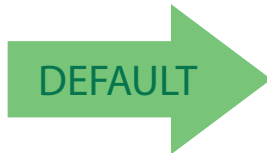

**10 = Quiet Interval of 100 ms**



## Intercharacter Delay

This parameter specifies the intercharacter delay between the end of one character and the beginning of the next. The delay can be set within a range of zero (0) to 990 milliseconds in 10ms increments. A setting of zero specifies no delay. See "Intercharacter Delay" on page 283 for more detailed programming instructions.



Select Intercharacter Delay Setting



Intercharacter Delay = No Delay

To configure this feature, scan the ENTER/EXIT bar code above, then the bar code at left followed by digits from the Alphanumeric characters in [Appendix D, Keypad](#) representing your desired character(s). End by scanning the ENTER/EXIT bar code again.

Make a mistake? Scan the CANCEL bar code to abort and not save the entry string. You can then start again at the beginning.



CANCEL

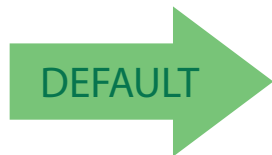

**00 = No Intercharacter Delay**



## Intercode Delay

Specifies the delay between labels transmitted to the host for this interface. The selectable range for this feature is from 0 to 99 seconds. See "Intercode Delay" on page 284 for more detailed programming instructions.



Set Intercode Delay

To configure this feature, scan the ENTER/EXIT bar code above, then the bar code at left followed by digits from the Alphanumeric characters in [Appendix D, Keypad](#) representing your desired character(s). End by scanning the ENTER/EXIT bar code again.

Make a mistake? Scan the CANCEL bar code to abort and not save the entry string. You can then start again at the beginning.

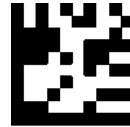

CANCEL

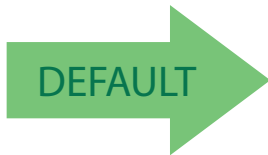

**00 = No Wedge Intercode Delay**



## USB Keyboard Speed

This option specifies the USB poll rate for a USB Keyboard.



**NOTE**

This feature applies **ONLY** to the USB Keyboard interface.

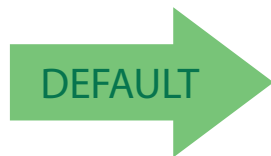

USB Keyboard Speed = 1ms



USB Keyboard Speed = 2ms



USB Keyboard Speed = 3ms



USB Keyboard Speed = 5ms



USB Keyboard Speed = 7ms



USB Keyboard Speed = 10ms

## USB Keyboard Numeric Keypad

This option Controls whether numeric characters will be sent using standard keys or the numeric keypad.

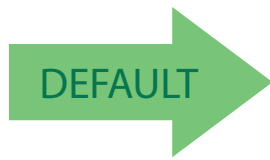

Standard Keys



Numeric Keypad



# USB-OEM Interface

<b>INTRODUCTION</b> on page 87
<b>STANDARD FACTORY SETTINGS</b> on page 87
<b>USB-OEM DEVICE USAGE</b> on page 88
<b>USB-OEM INTERFACE OPTIONS</b> on page 88

## Introduction

Feature settings for USB interfaces differ depending upon which host type the scanner will be connected with. Use the feature settings in this chapter to specifically configure for the USB-OEM interface. Other USB interfaces are included in the appropriate chapter for their host type.

## Standard Factory Settings

Reference [Appendix B](#), for a listing of standard factory settings.



## USB-OEM Device Usage

The USB-OEM protocol allows for the scanner to be identified as one of two different types of bar code scanners. Depending on what other scanners you may already have connected to a USB-OEM POS, you may need to change this setting to enable all devices to communicate.

Options are:

- Tabletop Scanner
- Handheld Scanner



**NOTE**

It may be necessary to switch device usage when connecting two scanners of the same type to a POS system.



USB-OEM Device Usage = Tabletop Scanner



USB-OEM Device Usage = Handheld Scanner



## USB-OEM Interface Options

This setting provides for an interface specific control mechanism.

Options are:

- Obey — Obey Scanner Configuration Host Commands
- Ignore — Ignore Scanner Configuration Host Commands



USB-OEM Interface Options = Obey



USB-OEM Interface Options = Ignore



# IBM 46XX Interface

Use the bar codes in this section to configure programmable features for available IBM 46XX interfaces.

Reference Appendix B, for a listing of standard factory settings..

<b>46XX NUMBER OF HOST RESETS</b> <a href="#">on page 72</a>
<b>TRANSMIT LABELS IN CODE 39 FORMAT</b> <a href="#">on page 92</a>
<b>INTERFACE OPTIONS</b> <a href="#">on page 92</a>



## 46xx Number of Host Resets

Specifies how many consecutive resets are processed before the reader starts a five-second period to allow the user to enter Programming Mode and configure the reader. The configurable range for this feature is 1 to 15 resets.



46xx Number of Host Resets = 1



46xx Number of Host Resets = 2



46xx Number of Host Resets = 3



46xx Number of Host Resets = 4



46xx Number of Host Resets = 5



46xx Number of Host Resets = 6



46xx Number of Host Resets = 7

## 46xx Number of Host Resets - cont.



46xx Number of Host Resets = 8



46xx Number of Host Resets = 9



46xx Number of Host Resets = 10



46xx Number of Host Resets = 11



46xx Number of Host Resets = 12



46xx Number of Host Resets = 13



46xx Number of Host Resets = 14



46xx Number of Host Resets = 15



## Transmit Labels in code 39 Format

This feature enable/disables translation to Code 39 before transmitting label data to an IBM-46XX or a USB-OEM host. Only the symbology identifier is modified for the translation. The data is not converted to Code 39 or verified to be valid for Code 39.

Options are:

**IBM Standard Format:** Send labels in standard IBM format.

**Code 39 Format:** Translate the following symbologies to Code 39:

- USB-OEM: Code128, Code 93, and Codabar
- IBM-Port 5B: Code 128, Code 93, and Codabar
- IBM-Port 9B: Code 93 and Codabar

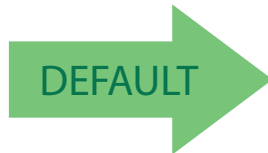

Transmit Labels in Code 39 Format = IBM Standard Format



Transmit Labels in Code 39 Format = Code 39 Format

## Interface Options

This feature provides for an interface-specific control mechanism.



Obey Scanner Configuration Host Commands



Ignore Scanner Configuration Host Commands



# Data Format

<b>GLOBAL PREFIX/SUFFIX</b> on page 76
<b>GLOBAL AIM ID</b> on page 77
<b>GS1-128 AIM ID</b> on page 77
<b>LABEL ID</b> starting on page 78 <ul style="list-style-type: none"><li>•Label ID: Pre-loaded Sets on page 78</li><li>•Label ID: Set Individually Per Symbology on page 79</li><li>•Label ID Control on page 79</li><li>•Label ID Symbology Selection on page 80</li></ul>
<b>CASE CONVERSION</b> on page 85
<b>CHARACTER CONVERSION</b> on page 86

The features in this chapter can be used to build specific user-defined data into a message string. See "References" starting on page 273 for more detailed instructions on setting these features.



## Global Prefix/Suffix

Up to 20 ASCII characters may be added as a prefix (in a position before the bar code data) and/or as a suffix (in a position following the bar code data). See "Global Prefix/Suffix" on page 286 for more detailed programming instructions.

To configure this feature, scan the ENTER/EXIT bar code above, then the bar code at left followed by digits from the Alphanumeric characters in [Appendix D, Keypad](#) representing your desired character(s). End by scanning the ENTER/EXIT bar code again.

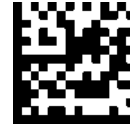

Set Global Prefix

To configure this feature, scan the ENTER/EXIT bar code above, then the bar code at left followed by digits from the Alphanumeric characters in [Appendix D, Keypad](#) representing your desired character(s). End by scanning the ENTER/EXIT bar code again.



Set Global Suffix

Make a mistake? Scan the CANCEL bar code to abort and not save the entry string. You can then start again at the beginning.

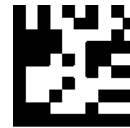

CANCEL

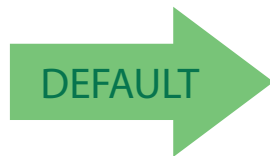

**No Global Prefix**  
**Global Suffix = 0x0D(CR)**





## Global AIM ID



This feature enables/disables addition of AIM IDs for all symbology types.

### NOTE

AIM label identifiers (as opposed to custom characters you select yourself as with label identifiers) can be included with scanned bar code data. See "Global AIM ID" on page 287 for more detailed programming instructions.

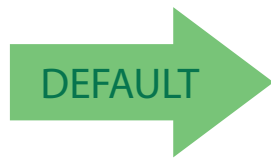

Global AIM ID = Disable



Global AIM ID = Enable

## GS1-128 AIM ID

If Global AIM ID is disabled, the AIM ID for GS1-128 can be enabled/disabled independently. The AIM ID for GS1-128 is a ]C1, ]C2 or ]C3. AIM IDs for other symbologies can be enabled/disabled independently as well. Contact Customer Support for assistance.



GS1-128 AIM ID = Disable



GS1-128 AIM ID = Enable





## Label ID

A Label ID is a customizable code of up to three ASCII characters (each can be one of hex 0x01–0xFF), used to identify a bar code (symbology) type. It can be appended previous to or following the transmitted bar code data depending upon how this option is enabled. This feature provides options for configuring custom Label IDs as a pre-loaded set (see "Label ID: Pre-loaded Sets" on page 78) or individually per symbology (see "Label ID: Set Individually Per Symbology" on page 79). If you wish to program the scanner to always include an industry standard label identifier for ALL symbology types, see the previous feature "Global AIM ID" on page 77.

### Label ID: Pre-loaded Sets

The scanner supports two pre-loaded sets of Label IDs, the USA set and the EU set. See "Label ID: Pre-loaded Sets" on page 288 for more information concerning the pre-loaded sets that are provided.



CAUTION

When changing from one Label ID set to another, all other scanner configuration settings, including the host interface type, will be erased and set to the factory defaults. Any custom configuration or custom defaults will be lost.



Label ID Pre-loaded Set = USA Set



Label ID Pre-loaded Set = EU Set



## Label ID: Set Individually Per Symbology

This feature configures a Label ID individually for a single symbology.



**NOTE**

This setting requires the scanning of bar codes from multiple sections. See "Label ID: Set Individually Per Symbology" on page 290 for more detailed programming instructions.

## Label ID Control

This option controls whether a Label ID is disabled, or sent as a prefix or suffix for a given symbology type.

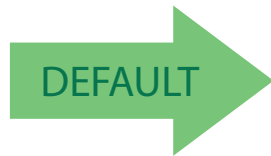

Label ID Transmission = Disable



Label ID Transmission = Enable as Prefix



Label ID Transmission = Enable as Suffix



## Label ID Symbology Selection

This option selects the symbology for which a Label ID is to be configured. See "Label ID: Set Individually Per Symbology" on page 290 for full instructions.

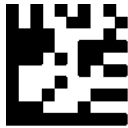

CANCEL

Make a mistake? Scan the CANCEL bar code to abort and not save the entry string. You can then start again at the beginning.

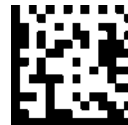

Set UPC-A Label ID Character(s)



Set UPC-A/P2 Label ID Character(s)



Set UPC-A/P5 Label ID Character(s)



Set UPC-E Label ID Character(s)



Set UPC-E/P2 Label ID Character(s)



Set UPC-E/P5 Label ID Character(s)



### Label ID Symbology Selection (continued)



Set EAN 13 Label ID Character(s)



Set EAN 13/P2 Label ID Character(s)



Set EAN 13/P5 Label ID Character(s)



Set EAN 8 Label ID Character(s)



Set EAN 8/P2 Label ID Character(s)



Set EAN 8/P5 Label ID Character(s)



## Label ID Symbology Selection (continued)



Set GS1 DataBar Omnidirectional Label ID Character(s)



Set GS1 DataBar Expanded Label ID Character(s)



Set GS1 DataBar Limited Label ID Character(s)



Set Code 39 Label ID Character(s)



Set Code 32 Label ID Character(s)



Set Code 39 CIP Label ID Character(s)



## Label ID Symbology Selection (continued)



Set Code 128 Label ID Character(s)



Set GS1-128 Label ID Character(s)



Set Interleaved 2 of 5 Label ID Character(s)



Set Interleaved 2 of 5 CIP HR Label ID Character(s)



Set Datalogic 2 of 5 CIP HR Label ID Character(s)



Set Codabar Label ID Character(s)



Set ABC Codabar Label ID Character(s)



## Label ID Symbology Selection (continued)



Set Code 11 Label ID Character(s)



Set Standard 2 of 5 Label ID Character(s)



Set Industrial 2 of 5 Label ID Character(s)



Set ISSN Label ID Character(s)



Set IATA Label ID Character(s)



Set Concatenated ISBT 128 Label ID Character(s)



Set MSI Label ID Character(s)



Set Code 93 Label ID Character(s)





## Label ID Symbology Selection (continued)



Set Follett 2 of 5 Label ID Character(s)



Set ISBN Label ID Character(s)



Set Concatenated ISBT Label ID Character(s)

## Case Conversion

This feature allows conversion of the case of all alphabetic characters to upper or lower case.



**NOTE**

Case conversion affects **ONLY** scanned bar code data, and does not affect Label ID, Prefix, Suffix, or other appended data.

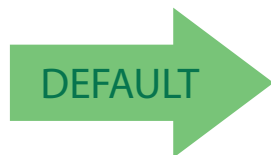

Case Conversion = Disable (no case conversion)



Case Conversion = Convert to upper case



Case Conversion = Convert to lower case



## Character Conversion

Character conversion is an eight byte configuration item. The eight bytes are 4 character pairs represented in hexadecimal ASCII values. The first character in the pair is the character that will be converted. The second character in the pair is the character to convert to. If the character to convert in a pair is FF, then no conversion is done. See "Character Conversion" on page 292 for more detailed programming instructions.



Configure Character Conversion

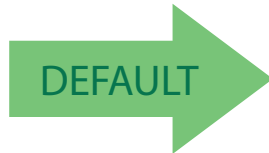

**0xFFFFFFFFFFFFFFF**  
**(No character conversion)**

Make a mistake? Scan the CANCEL bar code to abort and not save the entry string. You can then start again at the beginning.

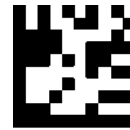

CANCEL

## Reading Parameters

<b>DOUBLE READ TIMEOUT</b> on page 106	<b>SCANNING FEATURES</b> on page 115
<b>LED AND SPEAKER INDICATORS</b> on page 109	<b>SCANNING FEATURES</b> on page 115
<b>POWER ON ALERT</b> on page 109	<b>SCANNING FEATURES</b> on page 115
<b>GOOD READ: WHEN TO INDICATE</b> on page 110	<b>SCAN MODE</b> on page 115
<b>GOOD READ: WHEN TO INDICATE</b> on page 110	<b>STAND MODE INDICATION</b> on page 118
<b>GOOD READ BEEP TYPE</b> on page 111	<b>STAND MODE INDICATION</b> on page 118
<b>GOOD READ BEEP FREQUENCY</b> on page 111	<b>FLASH ON TIME</b> on page 116
<b>GOOD READ SPEAKER VOLUME</b> on page 112	<b>FLASH OFF TIME</b> on page 117
<b>GOOD READ BEEP LENGTH</b> on page 113	<b>STAND MODE SENSITIVITY</b> on page 120
<b>ENABLE/DISABLE GOOD READ INDICATOR</b> on page 114	<b>PICK MODE</b> on page 106



## Double Read Timeout

To prevent a double read of the same label, the Double Read Timeout sets the minimum time allowed between reads of labels of the same symbology and data. If the unit reads a label and sees the same label again within the Double Read Timeout, the second read of the label will be ignored. Double Read Timeout does not apply to scan modes that require a trigger pull for each label that is read.



Double Read Timeout = 0.1 Second



Double Read Timeout = 0.2 Second



Double Read Timeout = 0.3 Second



Double Read Timeout = 0.4 Second



## Double Read Timeout (continued)



Double Read Timeout = 0.5 Second



Double Read Timeout = 0.6 Second



Double Read Timeout = 0.7 Second



Double Read Timeout = 0.8 Second



Double Read Timeout = 0.9 Second



Double Read Timeout = 1 Second



## Reading Performance

When the barcode scanner's Scan Mode is set to triggerless modes (e.g. Flashing, Always On, Stand Mode, etc.) the reading capabilities can be modified according to two main goals:

- Motion tolerance: increased performance for rapidly moving barcodes.
- Depth of field: increased performance for distant barcodes.

Depending on specific environmental conditions or user's circumstances or expected performances, one may decide to assign a higher priority to one or the other.



Depth of field



Motion tolerance





## LED and Speaker Indicators

### Power On Alert

Disables or enables the indication (from the Speaker) that the scanner is receiving power.



Power On Alert = Disable (No Audible Indication)



Power On Alert = Power-up Beep





## Good Read: When to Indicate

This feature specifies when the scanner will provide indication (beep and/or LED) upon successfully reading a bar code. Choices are:

- Good Read = Indicate after decode
- Good Read = Indicate after transmit
- Good Read = Indicate after CTS goes inactive, then active



### NOTE

This option, which uses CTS, is only valid for RS-232 interfaces.

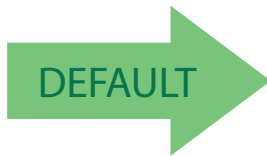

Indicate Good Read = After Decode



Indicate Good Read = After Transmit



Indicate Good Read = After CTS Goes Inactive, Then Active





## Good Read Beep Type

Specifies whether the good read beep has a mono or bitonal beep sound.



Good Read Beep Type = Mono



Good Read Beep Type = Bitonal

## Good Read Beep Frequency

Adjusts the good read beep to sound at a selectable low, medium or high frequency, selectable from the list below. (Controls the speaker's pitch/tone.)



Good Read Beep Frequency = Low



Good Read Beep Frequency = Medium

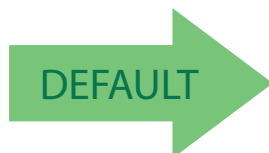

Good Read Beep Frequency = High



## Good Read Speaker Volume

Selects the speaker volume (loudness) upon a good read beep. There are three selectable volume levels.



Good Read Speaker Volume = Speaker Off



Good Read Speaker Volume = Low



Good Read Speaker Volume = Medium



Good Read Speaker Volume = High





## Good Read Beep Length

Specifies the duration of a good read beep.



Good Read Beep Length = 60 msec



Good Read Beep Length = 80 msec



Good Read Beep Length = 100 msec



Good Read Beep Length = 120 msec



Good Read Beep Length = 140 msec



Good Read Beep Length = 160 msec



## Good Read Beep Length (continued)



Good Read Beep Length = 180 msec



Good Read Beep Length = 200 msec

## Enable/Disable Good Read Indicator

Enable/Disable the good read indicator.



Good Read Indicator = Disable



Good Read Indicator = Enable





## Scanning Features

### Scan Mode

See "Scan Mode" on page 294 for more detailed programming instructions.



Scan Mode = Trigger Single



DEFAULT



Scan Mode = Trigger Hold Multiple



Scan Mode = Trigger Pulse Multiple



Scan Mode = Flashing



Scan Mode = Always On



Scan Mode = Stand Mode



## Flash On Time

This feature specifies the ON time for the indicator LED while in Flash Mode. The selectable range is 100 to 9,900 milliseconds (0.1 to 9.9 seconds), in 100 millisecond increments. See "Flash On Time" on page 297 for more detailed programming instructions.

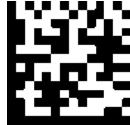

Select Flash ON Time Setting

To configure this feature, scan the ENTER/EXIT bar code above, then the bar code at left followed by digits from the Alphanumeric characters in [Appendix D, Keypad](#) representing your desired character(s). End by scanning the ENTER/EXIT bar code again.

Make a mistake? Scan the CANCEL bar code to abort and not save the entry string. You can then start again at the beginning.



CANCEL

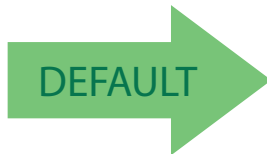

**10 = Flash is ON for 1 Second**



## Flash Off Time

This feature specifies the OFF time for the indicator LED while in Flash Mode. The selectable range is 100 to 9,900 milliseconds (0.1 to 9.9 seconds), in 100 millisecond increments. See "Flash Off Time" on page 298 for more detailed programming instructions.



Select Flash OFF Time Setting

To configure this feature, scan the ENTER/EXIT bar code above, then the bar code at left followed by digits from the Alphanumeric characters in [Appendix D, Keypad](#) representing your desired character(s). End by scanning the ENTER/EXIT bar code again.

Make a mistake? Scan the CANCEL bar code to abort and not save the entry string. You can then start again at the beginning.



CANCEL

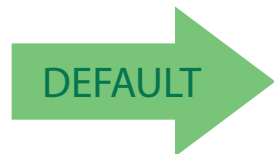

**06 = Flash is OFF for 600ms**



## Stand Mode Indication

Enables/disables the LED flash when the reader is in Stand Mode.

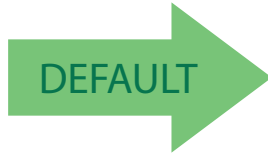

Stand Mode Flash = Disable



Stand Mode Flash = Enable





## Stand Operation

Specifies the behavior of the reader when stationary in a stand. There are two conditions which cause the reader to switch to Stand Mode:

1. The reader is configured to switch to Stand Mode when stationary.
2. The reader is placed into the cradle of the base station.

Below are further options concerning Stand Operation.

**Ignore Autorecognition.** Disables mode switching when the reader is placed in a stand.

**Switch to Stand Mode.** Automatically switches the reader to Stand Mode when the reader is placed in the stand.

**Switch to Flashing.** Automatically switches the reader to Flash Mode when the reader is placed in the stand.

**Switch to Always On.** Automatically switches the reader to Always On mode when the reader is placed in the stand.





## Stand Mode Sensitivity

Sets the sensitivity level for stand mode wakeup. Choices are low, medium and high.



Stand Mode Sensitivity = Low



Stand Mode Sensitivity = Medium



Stand Mode Sensitivity = High

## Stand Mode Illumination Off Time

Specifies the amount of time reader illumination stays off after pulling the trigger when in Stand Mode. The configurable range is 01 to 32 by 01 in increments of 500ms (500ms to 16 seconds). See [page 287](#) in “References” for a description of this feature.



Select Stand Mode Time Setting

To configure this feature, scan the ENTER/EXIT PROGRAMMING MODE bar code above, then the bar code at left followed by the digits from the Alphanumeric characters in [Appendix D, Keypad](#) representing your desired character(s). End by scanning the ENTER/EXIT bar code again.

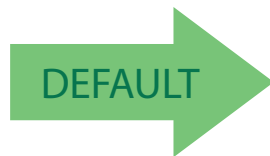

**04 = 2 Seconds**

## Scanning Active Time

This setting specifies the amount of time that the reader stays in scan ON state once the state is entered. The range for this setting is from 1 to 255 seconds in 1-second increments. See [page 288](#) in “References” for further description of this feature.



Scanning Active Time = 3 seconds

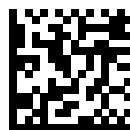

Scanning Active Time = 5 seconds



Scanning Active Time = 8 seconds

## Stand Illumination Control

Controls the illumination status while the reading mode is stand mode and the reader is attempting to detect objects.

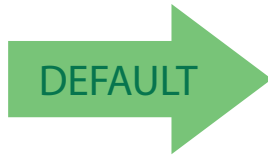

Stand Illumination Control = OFF



Stand Illumination Control = ON



Stand Illumination Control = Dim

## Motion Still Timeout

Motion Still Timeout specifies the waiting time after which no motions is detected. When no motion is detected for period of time longer than the set Motion Still Timeout period, the scanner assumes it is in a motionless condition. The selectable settings are from 500 to 25,500 milliseconds in 100 millisecond increments. The default is 2 seconds. This option relates to such features and the Aimer On timing and Stand Mode Object Sense scanning with respect to motion.



Select Motion Still Timeout Setting

To configure this feature, scan the ENTER/EXIT PROGRAMMING MODE bar code above, then the bar code at left followed by the digits from the Alphanumeric characters in [Appendix D, Keypad](#) representing your desired character(s). End by scanning the ENTER/EXIT bar code again.

Make a mistake? Scan the CANCEL bar code to abort and not save the entry string. You can then start again at the beginning.

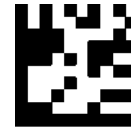

CANCEL

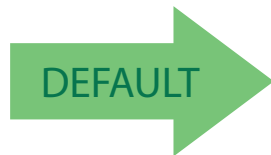

**14 = Motion Still Timeout for 2 seconds**

## Pick Mode

Specifies the ability of the reader to decode labels only when they are close to the center of the aiming pattern. This allows the reader to accurately target labels when they are placed close together, such as on a pick sheet.

The Pick Mode can be enabled only in Trigger Single Scan Mode.



**NOTE**

This feature is not compatible with Multiple Labels Reading in a Volume.

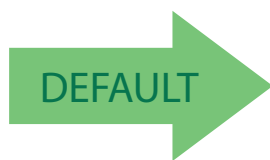

Pick Mode = Disable



Pick Mode = Enable

## Aiming Pointer

Enables/disables the aiming pointer for all symbologies.



Aiming Pointer = Disable



Aiming Pointer = Enable



## Aiming Duration Timer

Specifies the frame of time the aiming pointer remains on after decoding a label, when in trigger single mode. The range for this setting is from 1 to 255 seconds in 1-second increments. See [page 289](#) in “References” for a description of this feature.

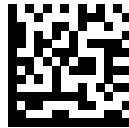
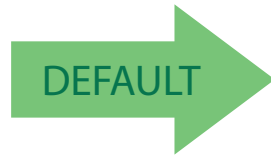

Set Aiming Duration Timer



Aiming Off After Decoding

To configure, scan the ENTER/EXIT PROGRAMMING MODE bar code above, then the bar code at left followed by the digits from the Alphanumeric characters in [Appendix D, Keypad](#) representing your desired character(s). End by scanning the ENTER/EXIT bar code.

Make a mistake? Scan the CANCEL bar code to abort and not save the entry string. You can then start again at the beginning.

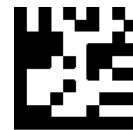

CANCEL

## Green Spot Duration

Specifies the duration of the good read pointer beam after a good read.



Green Spot Duration = Disable (Green Spot is Off)



Green Spot Duration = Short (300 msec)



Green Spot Duration = Medium (500 msec)



Green Spot Duration = Long (800 msec)



## Mobile Phone Mode

This mode is useful for scanning bar codes displayed on a mobile phone. Other options for this feature can be configured using the Datalogic Aladdin application.

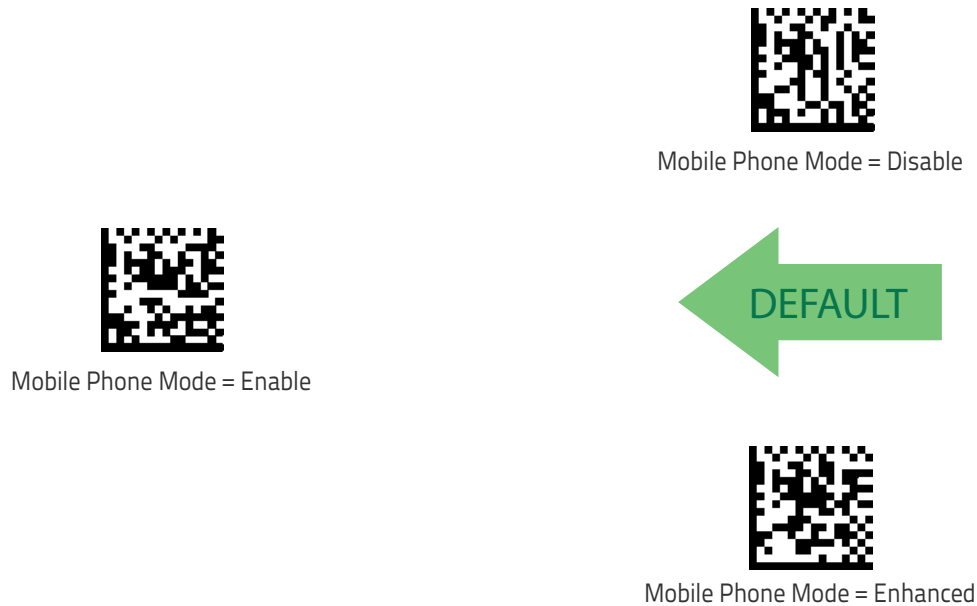

## Partial Label Reading Control

Enable/Disable to ignore partial labels to be read within the boundary of the field of view.



## Decode Negative Image

Enable/Disable the ability to decode a negative image for all symbologies. When this feature is enabled, you will be unable to read normally–printed labels or programming labels in this manual. Scan the “Disable” bar code below to return the scanner to its default for this feature. To set decoding for only 2D codes, go to ["2D Normal/Inverse Symbol Control" on page 209](#). For additional options, see the Aladdin configuration application.



### NOTE

Unlike some programming features and options, Decode Negative Image selections require that you scan only one programming bar code label. **DO NOT** scan an ENTER/EXIT bar code prior to scanning a Decode Negative Image bar code.



### CAUTION

When this feature is enabled, you will be unable to read other programming labels in this manual.

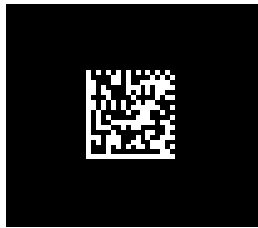

Decode Negative Image = Disable



Decode Negative Image = Enable

## Image Capture

For information and a list of options for Image Capture, use the Datalogic Aladdin configuration application, available for free download from the Datalogic Scanning website.

---

## CORDED ONLY FEATURES

### Corded Stand Mode

Sets the Stand Mode Operation for Corded models



**NOTE**

This feature is available starting with firmware release 610001013.

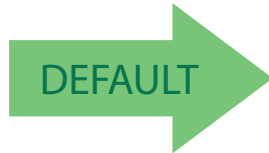

Corded Stand Mode = Disable



Corded Stand Mode = Generic Stand



Corded Stand Mode = for All-in-one and Base



Corded Stand Mode = Precise Stand

## Corded Stand Beep

Enables/Disables the beep that indicates when Corded Stand position is detected.



**NOTE**

This feature is available starting on firmware release 610001013.



Corded Stand Beep = Disable

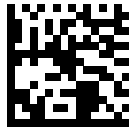

Corded Stand Beep = Enable

## MULTIPLE LABEL READING

In standard (default) mode, when the reader's aiming system is activated (by a trigger pull, motion or other method depending on the mode), it then acquires and processes each image in the area in front of it (the Volume). In this case, the scanner stops processing the image once it decodes a label. If several labels are present in the volume, only the first label encountered is decoded and sent.

When Multiple Reading Mode is enabled, the scanner keeps on processing the image until all the labels present are decoded. The reader then sorts the data from all the bar codes (if configured to do so) before transmitting it.

### Multiple Labels per Frame

Specifies the ability of the reader to decode and transmit a set of code labels in a specific volume and in a single frame of time. When in Multiple Labels per Frame the reader beeps and turns on the good read LED indication for each code read in a frame.

When Multiple Labels Mode is enabled, ISBT pairing, ABC Codabar pairing, and composites are not allowed.

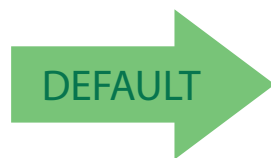

Multiple Labels per Frame = Disable



Multiple Labels per Frame = Enable

## Multiple Labels Ordering by Code Symbology

This feature allows you to specify the order multiple labels are transmitted by symbology type, when Multiple Labels per Frame is enabled. See [page 292](#) in “References” for detailed information on setting this feature.



Select Symbologies for Multiple Labels Ordering

To configure this feature, scan the ENTER/EXIT PROGRAMMING MODE bar code above, then the bar code at left followed by the digits from the alphanumeric characters in Appendix d, keypad representing your desired Character(s), end by scanning the enter/exit bar code again.

Make a mistake? Scan the CANCEL bar code to abort and not save the entry string. You can then start again at the beginning.

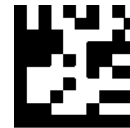

CANCEL

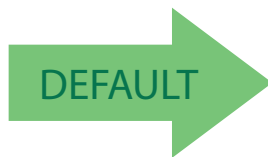

00000000000 = Random order

## Multiple Labels Ordering by Code Length

Specifies the transmission ordering by code length, when Multiple Labels per Frame is enabled.

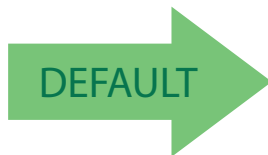

Multiple Labels Ordering = Disable



Transmit Increasing Length Order



Transmit Decreasing Length Order

# 1D Symbologies

## Introduction

The scanner supports the following 1D symbologies (bar code types). Symbology-dependent options for each symbology are included in this chapter. See "2D Symbologies" starting on page 215 for configuration of 2D bar codes.

<b>UPC-A</b> on page 135	<b>INTERLEAVED 2 OF 5 (I 2 OF 5)</b> on page 169
<b>UPC-E</b> on page 138	<b>INTERLEAVED 2 OF 5 CIP HR</b> on page 174
<b>EAN 13</b> on page 140	<b>DATALOGIC 2 OF 5</b> on page 174
<b>EAN 13</b> on page 140 (JAN 13)	<b>CODABAR</b> on page 178
<b>EAN 8</b> on page 143 (JAN 8)	<b>ABC CODABAR</b> on page 184
<b>ADD-ONS</b> on page 146	<b>CODE 11</b> on page 186
<b>GS1 DATABAR™ OMNIDIRECTIONAL</b> on page 148	<b>STANDARD 2 OF 5</b> on page 190
<b>GS1 DATABAR™ EXPANDED</b> on page 150	<b>INDUSTRIAL 2 OF 5</b> on page 194
<b>GS1 DATABAR™ LIMITED</b> on page 153	<b>IATA</b> on page 198
<b>CODE 39</b> on page 154	<b>ISBT 128</b> on page 199
<b>CODE 32 (ITALIAN PHARMACEUTICAL)</b> on page 161	<b>MSI</b> on page 202
<b>CODE 39 CIP (FRENCH PHARMACEUTICAL)</b> on page 162	<b>CODE 93</b> on page 206
<b>CODE 128</b> on page 163	<b>FOLLETT 2 OF 5</b> on page 211
<b>GS1-128</b> on page 168	<b>BC412</b> on page 211

## Standard Factory Settings for Symbologies

Default settings are indicated at each feature/option with a green arrow. Also reference [Appendix B](#), for a listing of the most widely used set of standard factory settings. That section also provides space to record any custom settings needed or implemented for your system.



## Disable All Symbologies

Scan this label to disable all symbologies.



Disable all symbologies

## Coupon Control

This feature is used to control the method of processing coupon labels.

Options are:

- Allow all — allow all coupon bar codes to be decoded
- Enable only UPC/EAN — enables only UPC/EAN coupon decoding
- Enable only GS1 DataBar — enables only GS1 DataBar coupon decoding

To set this feature:

1. Scan the Enter/Exit bar code.
2. Scan either the enable or disable bar code below. You'll need to cover any unused bar codes on this and the facing page to ensure that the scanner sees only the bar code you intend to scan.
3. Complete the programming sequence by scanning the Enter/Exit bar code.



Coupon Control = Allow all



Coupon Control = Enable only UPC/EAN



Coupon Control = Enable only GS1 DataBar



## UPC-A

The following options apply to the UPC-A symbology.

### UPC-A Enable/Disable

When disabled, the scanner will not read UPC-A bar codes.



### UPC-A Check Character Transmission

Enable this option to transmit the check character along with UPC-A bar code data.





## Expand UPC-A to EAN-13

Expands UPC-A data to the EAN-13 data format. Selecting this feature also changes the symbology ID to match those required for EAN-13.

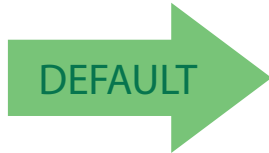

UPC-A to EAN-13 = Don't Expand



UPC-A to EAN-13 = Expand

## UPC-A Number System Character Transmission

This feature enables/disables transmission of the UPC-A number system character.



UPC-A Number System Character = Do not transmit



UPC-A Number System Character = Transmit



## UPC-A 2D Component

This feature enables/disables a requirement that a 2D label component be decoded when a base label of this symbology is decoded.

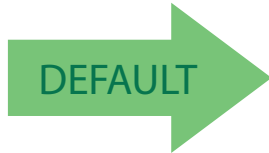

EAN-13 2D Component =  
Disable (2D component not required)



EAN-13 2D Component =  
2D component must be decoded



## UPC-E

The following options apply to the UPC-E symbology.

### UPC-E Enable/Disable

When disabled, the scanner will not read UPC-E bar codes.



UPC-E = Disable



UPC-E = Enable



### UPC-E Check Character Transmission

Enable this option to transmit the check character along with UPC-E bar code data.



UPC-E Check Character Transmission = Don't Send



UPC-E Check Character Transmission = Send



## Expand UPC-E to EAN-13

Expands UPC-E data to the EAN-13 data format. Selecting this feature also changes the symbology ID to match those required for EAN-13.

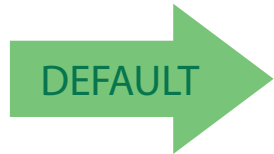

UPC-E to EAN-13 = Don't Expand



UPC-E to EAN-13 = Expand

## Expand UPC-E to UPC-A

Expands UPC-E data to the UPC-A data format.

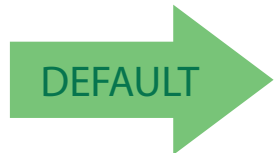

UPC-E to UPC-A = Don't Expand



UPC-E to UPC-A = Expand

## UPC-E Number System Character Transmission

This feature enables/disables transmission of the UPC-E system number character.



UPC-E Number System Character = Do not transmit



UPC-E Number System Character = Transmit





## EAN 13

The following options apply to the EAN 13 (Jan 13) symbology.

### EAN 13 Enable/Disable

When disabled, the scanner will not read EAN 13/JAN 13 bar codes.



EAN 13 = Disable



EAN 13 = Enable



### EAN 13 Check Character Transmission

Enable this option to transmit the check character along with EAN 13 bar code data.



EAN 13 Check Character Transmission = Don't Send



EAN 13 Check Character Transmission = Send



## EAN-13 Flag 1 Character

Enables/disables transmission of an EAN/JAN13 Flag1 character. The Flag 1 character is the first character of the label.



EAN-13 Flag 1 Char= Don't transmit



EAN-13 Flag 1 Char= Transmit



## EAN-13 ISBN Conversion

This option enables/disables conversion of EAN 13/JAN 13 Bookland labels starting with 978 to ISBN labels.

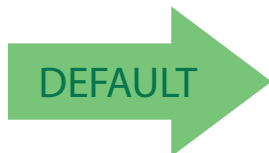

EAN-13 ISBN Conversion = Disable



EAN-13 ISBN Conversion = Convert to ISBN



### EAN-13 2D Component

This feature enables/disables a requirement that a 2D label component be decoded when a base label of this symbology is decoded.

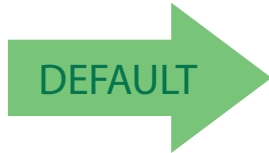

EAN-13 2D Component =  
Disable (2D component not required)



EAN-13 2D Component =  
2D component must be decoded

### ISSN Enable/Disable

Enables/disables conversion of EAN/JAN 13 Bookland labels starting with 977 to ISSN labels.

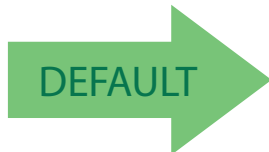

ISSN = Disable



ISSN = Enable



## EAN 8

The following options apply to the EAN 8 (Jan 8) symbology.

### EAN 8 Enable/Disable

When disabled, the scanner will not read EAN 8/JAN 8 bar codes.



### EAN 8 Check Character Transmission

Enable this option to transmit the check character along with EAN 8 bar code data.





## Expand EAN 8 to EAN 13

Enable this option to expand EAN 8/JAN 8 labels to EAN 13/JAN 13.

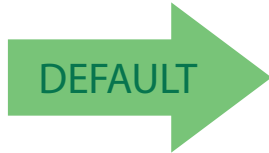

Expand EAN 8 to EAN 13 = Disable



Expand EAN 8 to EAN 13 = Enable

## EAN 8 2D Component

This feature enables/disables a requirement that a 2D label component be decoded when a base label for this symbology is decoded.

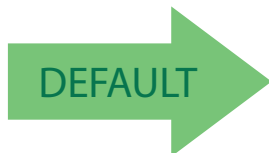

EAN 8 2D Component =  
Disable (2D component not required)



EAN 8 2D Component =  
2D component must be decoded

## UPC/EAN Global Settings

This section provides configuration settings for UPC-A, UPC-E, EAN 13 and EAN 8 symbologies, and affects all of these unless otherwise marked for each feature description.

### UPC/EAN Price Weight Check

This feature enables/disables calculation and verification of price/weight check digits.

Options are

- Disabled
- Enable 4-digit price-weight check-digit calculation
- Enable 5-digit price-weight check-digit calculation
- Enable European 4-digit price-weight check-digit calculation
- Enable European 5-digit price-weight check-digit calculation

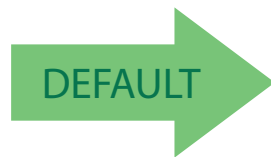

Price Weight Check = Disabled



Price Weight Check = 4-digit price-weight check



Price Weight Check = 5-digit price-weight check



Price Weight Check = European 4-digit price-weight check



Price Weight Check = European 5-digit price-weight check



# Add-Ons

The following features apply to optional add-ons.



Contact Customer Support for advanced programming of optional and conditional add-ons.

## Optional Add-ons

The scanner can be enabled to optionally read the following add-ons (supplementals):

- P2
- P5



If a UPC/EAN base label and a an add-on are both decoded, the scanner will transmit the base label and add-on. If a UPC/EAN base label is decoded without an add-on, the base label will be transmitted without an add-on. Conditional add-on settings (if enabled) are considered by the scanner before optional add-on settings.

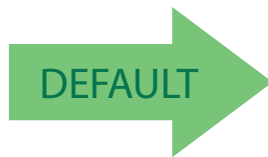

Optional Add-Ons = Disable P2



Optional Add-Ons = Enable P2

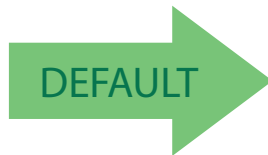

Optional Add-Ons = Disable P5



Optional Add-Ons = Enable P5

## Optional Add-On Timer

This option sets the time the scanner will look for an add-on when an add-on fragment has been seen and optional add-ons are enabled.



Optional Add-on Timer = 10ms



Optional Add-on Timer = 20ms



Optional Add-on Timer = 30ms



Optional Add-on Timer = 50ms



Optional Add-on Timer = 70ms



Optional Add-on Timer = 100ms



Optional Add-on Timer = 160ms



## GS1 DataBar™ Omnidirectional

The following options apply to the GS1 DataBar Omnidirectional (formerly RSS-14) symbology.

### GS1 DataBar Omnidirectional Enable/Disable

When disabled, the scanner will not read GS1 DataBar Omnidirectional bar codes.

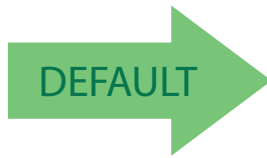

GS1 DataBar Omnidirectional = Disable



GS1 DataBar Omnidirectional = Enable

### GS1 DataBar Omnidirectional GS1-128 Emulation

When enabled, GS1 DataBar Omnidirectional bar codes will be translated to the GS1-128 label data format.

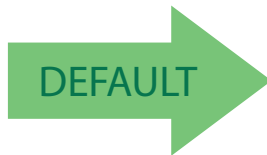

GS1 DataBar Omnidirectional GS1-128 Emulation = Disable



GS1 DataBar Omnidirectional GS1-128 Emulation = Enable

## GS1 DataBar™ Omnidirectional 2D Component

This feature enables/disables a requirement that a 2D label component be decoded when a base label for this symbology is decoded.

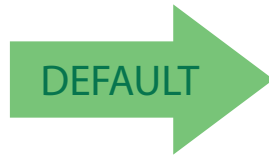

GS1 DataBar™ Omnidirectional 2D Component =  
Disable (2D component not required)



GS1 DataBar™ Omnidirectional 2D Component =  
2D component must be decoded



## GS1 DataBar™ Expanded

The following options apply to the GS1 DataBar Expanded (formerly RSS Expanded) symbology.

### GS1 DataBar Expanded Enable/Disable

When disabled, the scanner will not read GS1 DataBar Expanded bar codes.

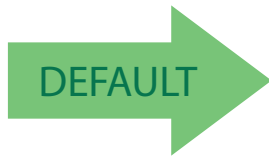

GS1 DataBar Expanded = Disable



GS1 DataBar Expanded = Enable

### GS1 DataBar Expanded GS1-128 Emulation

When enabled, GS1 DataBar Expanded bar codes will be translated to the GS1-128 label data format.

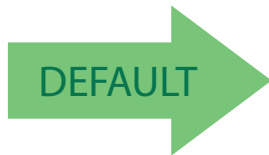

GS1 DataBar Expanded GS1-128 Emulation = Disable



GS1 DataBar Expanded GS1-128 Emulation = Enable



## GS1 DataBar Expanded Length Control

This feature specifies either variable length decoding or fixed length decoding for the GS1 DataBar Expanded symbology.

**Variable Length:** For variable-length decoding, a minimum length may be set.

**Fixed Length:** For fixed-length decoding, two different lengths may be set.

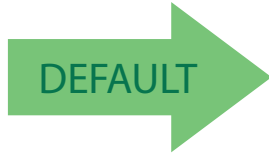

GS1 DataBar Expanded Length Control = Variable Length



GS1 DataBar Expanded Length Control = Fixed Length

## GS1 DataBar Expanded Set Length 1

This feature specifies one of the bar code lengths for [GS1 DataBar Expanded Length Control on page 151](#). Length 1 is the minimum label length if in [Variable Length on page 151](#) Mode, or the first fixed length if in [Fixed Length on page 151](#) Mode. Length includes the bar code's data characters only.

The length can be set from 1 to 74 characters. See ["Set Length 1" on page 302](#) for more detailed programming instructions.



Select GS1 DataBar Expanded Set Length 1 Setting

To configure this feature, scan the ENTER/EXIT bar code above, then the bar code at left followed by digits from the Alphanumeric characters in [Appendix D, Keypad](#) representing your desired character(s). End by scanning the ENTER/EXIT bar code again.

Make a mistake? Scan the CANCEL bar code to abort and not save the entry string. You can then start again at the beginning.



CANCEL

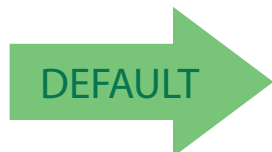

**01 = Length 1 is 1 Character**



## GS1 DataBar Expanded Set Length 2

This feature specifies one of the bar code lengths for [GS1 DataBar Expanded Length Control on page 151](#). Length 2 is the maximum label length if in [Variable Length on page 151 Mode](#), or the second fixed length if in [Fixed Length on page 151 Mode](#). Length includes the bar code's data characters only.

The length can be set from 1 to 74 characters. A setting of 00 specifies to ignore this length (only one fixed length). See ["Set Length 2" on page 303](#) for more detailed programming instructions.

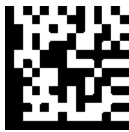

Select GS1 DataBar Expanded Set Length 2 Setting

To configure this feature, scan the ENTER/EXIT bar code above, then the bar code at left followed by digits from the Alphanumeric characters in [Appendix D, Keypad](#) representing your desired character(s). End by scanning the ENTER/EXIT bar code again.

Make a mistake? Scan the CANCEL bar code to abort and not save the entry string. You can then start again at the beginning.

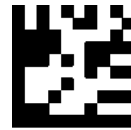

CANCEL

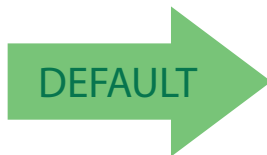

**74 = Length 2 is 74 Characters**

## GS1 DataBar™ Limited

The following options apply to the GS1 DataBar Limited (formerly RSS Limited) symbology.

### GS1 DataBar Limited Enable/Disable

When disabled, the scanner will not read GS1 DataBar Limited bar codes.

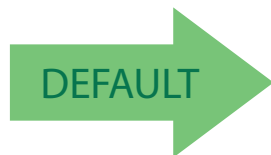

GS1 DataBar Limited = Disable



GS1 DataBar Limited = Enable

### GS1 DataBar Limited GS1-128 Emulation

When enabled, GS1 DataBar Limited bar codes will be translated to the GS1-128 label data format.

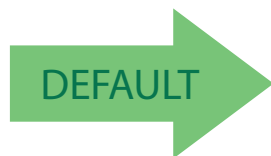

GS1 DataBar Limited GS1-128 Emulation = Disable



GS1 DataBar Limited GS1-128 Emulation = Enable



## Code 39

The following options apply to the Code 39 symbology.

### Code 39 Enable/Disable

When disabled, the scanner will not read Code 39 bar codes.



Code 39 = Disable



Code 39 = Enable



### Code 39 Check Character Calculation

Enable this option to enable/disable calculation and verification of an optional Code 39 check character. When disabled, any check character in the label is treated as a data character.

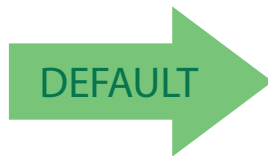

Code 39 Check Character Calculation = Don't Calculate



Code 39 Check Character Calculation = Calculate Std Check



Code 39 Check Character Calculation = Calculate Mod 7 Check

### Code 39 Check Character Calculation (continued)



Code 39 Check Character Calculation = Enable Italian Post Check



Code 39 Check Character Calculation = Enable Daimler Chrysler Check

### Code 39 Check Character Transmission

Enable this option to transmit the check character along with Code 39 bar code data.



Code 39 Check Character Transmission = Don't Send



Code 39 Check Character Transmission = Send





## Code 39 Start/Stop Character Transmission

Enable this option to enable/disable transmission of Code 39 start and stop characters.

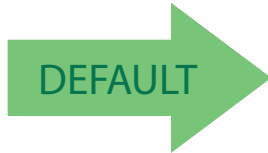

Code 39 Start/Stop Character Transmission = Don't Transmit



Code 39 Start/Stop Character Transmission = Transmit

## Code 39 Full ASCII

In Code 39 decoding, this enables/disables the translation of Code 39 characters to Code 39 full-ASCII characters.

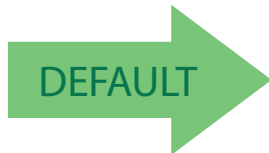

Code 39 Full ASCII = Disable



Code 39 Full ASCII = Enable

## Code 39 Quiet Zones

This feature specifies the number of quiet zones for Code 39 labels. Quiet zones are blank areas at the ends of a bar code and are typically 10 times the width of the narrowest bar or space in the label.



Code 39 Quiet Zones = Quiet Zone on one side



Code 39 Quiet Zones = Quiet Zones on two sides



Code 39 Quiet Zones = Auto



Code 39 Quiet Zones = Virtual Quiet Zones on two sides



Code 39 Quiet Zones = Small Quiet Zones on two sides



## Code 39 Length Control

This feature specifies either variable length decoding or fixed length decoding for the Code 39 symbology.

**Variable Length:** For variable length decoding, a minimum and maximum length may be set.

**Fixed Length:** For fixed length decoding, two different lengths may be set.

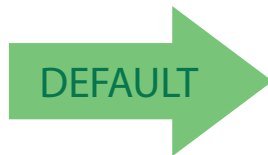

Code 39 Length Control = Variable Length



Code 39 Length Control = Fixed Length



## Code 39 Set Length 1

This feature specifies one of the bar code lengths for [Code 39 Length Control on page 158](#). Length 1 is the minimum label length if in [Variable Length on page 158 Mode](#), or the first fixed length if in [Fixed Length on page 158 Mode](#). Length includes the bar code's check, data, and full-ASCII shift characters. The length does not include start/stop characters.

The length can be set from 0 to 50 characters. See ["Set Length 1" on page 302](#) for more detailed programming instructions.



Select Code 39 Set Length 1 Setting

To configure this feature, scan the ENTER/EXIT bar code above, then the bar code at left followed by digits from the Alphanumeric characters in [Appendix D, Keypad](#) representing your desired character(s). End by scanning the ENTER/EXIT bar code again.

Make a mistake? Scan the CANCEL bar code to abort and not save the entry string. You can then start again at the beginning.



CANCEL

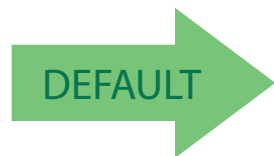

**02 = Length 1 is 2 Characters**



## Code 39 Set Length 2

This feature specifies one of the bar code lengths for [Code 39 Length Control on page 158](#). Length 2 is the maximum label length if in [Variable Length on page 158 Mode](#), or the second fixed length if in [Fixed Length on page 158 Mode](#). Length includes the bar code's check, data, and full-ASCII shift characters. The length does not include start/stop characters.

The length can be set from 1 to 50 characters. A setting of 00 specifies to ignore this length (only one fixed length). See ["Set Length 2" on page 303](#) for more detailed programming instructions.



Select Code 39 Length 2 Setting

To configure this feature, scan the ENTER/EXIT bar code above, then the bar code at left followed by digits from the Alphanumeric characters in [Appendix D, Keypad](#) representing your desired character(s). End by scanning the ENTER/EXIT bar code again.

Make a mistake? Scan the CANCEL bar code to abort and not save the entry string. You can then start again at the beginning.



CANCEL

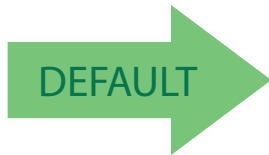

**50 = Length 2 is 50 Characters**

## Code 32 (Italian Pharmaceutical)

The following options apply to the Code 32 symbology.

### Code 32 Enable/Disable

When disabled, the scanner will not read Code 32 bar codes.

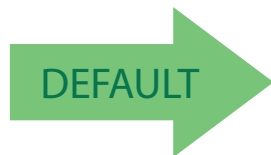

Code 32 = Disable



Code 32 = Enable

### Code 32 Feature Setting Exceptions



NOTE

The following features are set for Code 32 by using these Code 39 settings:

"Code 39 Quiet Zones" on page 157

"Code 39 Length Control" on page 158

### Code 32 Check Character Transmission

Enable this option to transmit the check character along with Code 32 bar code data.

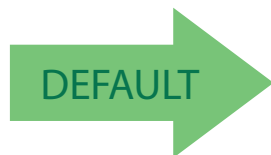

Code 32 Check Character Transmission = Don't Send



Code 32 Check Character Transmission = Send



## Code 32 Start/Stop Character Transmission

This option enables/disables transmission of Code 32 start and stop characters.

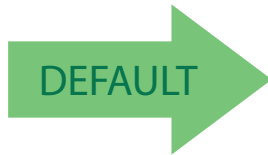

Code 32 Start/Stop Character Transmission = Don't Transmit



Code 32 Start/Stop Character Transmission = Transmit

## Code 39 CIP (French Pharmaceutical)

The following options apply to the Code 39 CIP symbology.

### Code 39 CIP Enable/Disable

Enables/Disables ability of the scanner to decode Code 39 CIP labels.



Code 39 CIP = Disable



Code 39 CIP = Enable

## Code 128

The following options apply to the Code 128 symbology.

### Code 128 Enable/Disable

When disabled, the scanner will not read Code 128 bar codes.



### Expand Code 128 to Code 39

This feature enables/disables expansion of Code 128 labels to Code 39 labels. When enabled, the label identifier for a Code 128 label shall be set to Code 39 and all Code 39 formatting control shall be applied to the label.

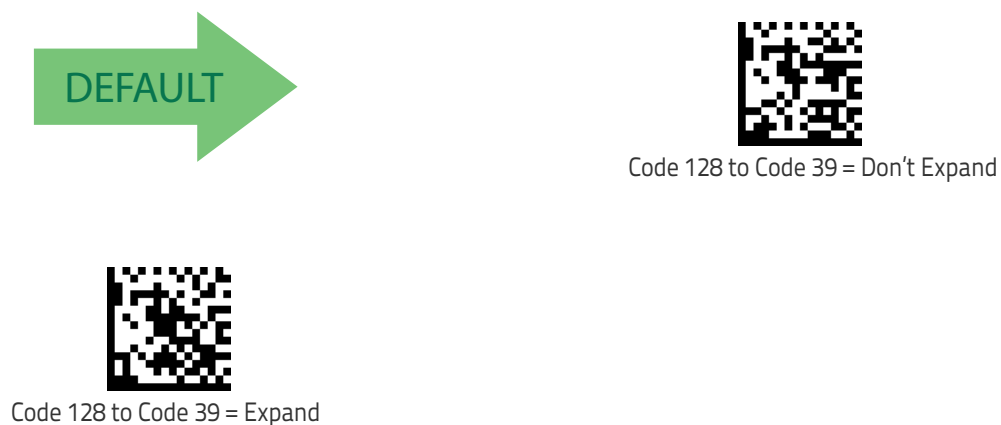



## Code 128 Check Character Transmission

Enable this option to transmit the check character along with Code 128 bar code data.

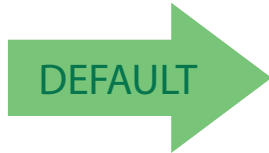

Code 128 Check Character Transmission = Don't Send



Code 128 Check Character Transmission = Send

## Code 128 Function Character Transmission

Enables/disables transmission of Code128 function characters 1, 2, 3, and 4.

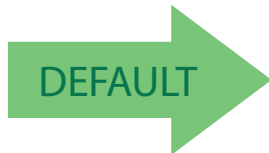

Code 128 Function Character Transmission = Don't Send



Code 128 Function Character Transmission = Send

## Code 128 Quiet Zones

This feature specifies the number of quiet zones for Code 128 labels. Quiet zones are blank areas at the ends of a bar code and are typically 10 times the width of the narrowest bar or space in the label.



Code 128 Quiet Zones = No Quiet Zones



Code 128 Quiet Zones = Quiet Zone on one side



Code 128 Quiet Zones = Quiet Zones on two sides



Code 128 Quiet Zones = Auto



Code 128 Quiet Zones = Virtual Quiet Zones on two sides



### Code 128 Length Control

This feature specifies either variable length decoding or fixed length decoding for the Code 128 symbology.

**Variable Length:** For variable length decoding, a minimum and maximum length may be set.

**Fixed Length:** For fixed length decoding, two different lengths may be set.

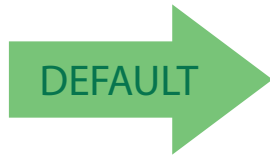

Code 128 Length Control = Variable Length



Code 128 Length Control = Fixed Length

### Code 128 Set Length 1

This feature specifies one of the bar code lengths for **Code 128 Length Control** on page 166. Length 1 is the minimum label length if in **Variable Length** on page 166 Mode, or the first fixed length if in **Fixed Length** on page 166 Mode. Length includes the bar code's data characters only.

The length can be set from 1 to 80 characters. See "**Set Length 1**" on page 302 for more detailed programming instructions.



Select Code 128 Set Length 1 Setting

To configure this feature, scan the ENTER/EXIT bar code above, then the bar code at left followed by digits from the Alphanumeric characters in **Appendix D, Keypad** representing your desired character(s). End by scanning the ENTER/EXIT bar code again.

Make a mistake? Scan the CANCEL bar code to abort and not save the entry string. You can then start again at the beginning.

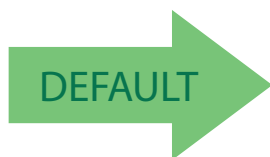

**01 = Length 1 is 1 Character**



## Code 128 Set Length 2

This feature specifies one of the bar code lengths for [Code 128 Length Control on page 166](#). Length 2 is the maximum label length if in [Variable Length on page 166 Mode](#), or the second fixed length if in [Fixed Length on page 166 Mode](#). Length includes the bar code's data characters only.

The length can be set from 1 to 80 characters. A setting of 00 specifies to ignore this length (only one fixed length). See ["Set Length 2" on page 303](#) for more detailed programming instructions.



Select Code 128 Length 2 Setting

To configure this feature, scan the ENTER/EXIT bar code above, then the bar code at left followed by digits from the Alphanumeric characters in [Appendix D, Keypad](#) representing your desired character(s). End by scanning the ENTER/EXIT bar code again.

Make a mistake? Scan the CANCEL bar code to abort and not save the entry string. You can then start again at the beginning.



CANCEL

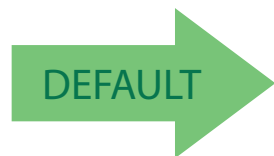

**80 = Length 2 is 80 Characters**



## GS1-128

The following options apply to the GS1-128 symbology. (Also known as USS-128, GTIN-128, UCC-128.)

### GS1-128 Enable

This option enables/disables the ability of the scanner to translate GS1-128 labels to the GS1-128 data format. Options are:

- Transmit GS1-128 labels in Code 128 data format.
- Transmit GS1-128 labels in GS1-128 data format.
- Do not transmit GS1-128 labels.



GS1-128 = Transmit in Code 128 data format



GS1-128 = Transmit in GS1-128 data format



GS1-128 = Do not transmit GS1-128 labels

### GS1-128 2D Component

This feature enables/disables a requirement that a 2D label component be decoded when a base label of this symbology is decoded.

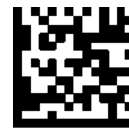
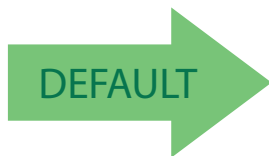

GS1-128 2D Component = Disable



GS1-128 2D Component = Enable

## Interleaved 2 of 5 (I 2 of 5)

The following options apply to the I 2 of 5 symbology.



When reading this symbology, the settings for I 2 of 5 Length Control AND I 2 of 5 Check Character Calculation **MUST** be enabled to increase decoding safety.

### I 2 of 5 Enable/Disable

When disabled, the scanner will not read I 2 of 5 bar codes.

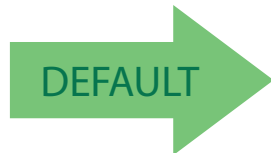



## 1 2 of 5 Check Character Calculation

This option enables/disables calculation and verification of an optional 1 2 of 5 check character.

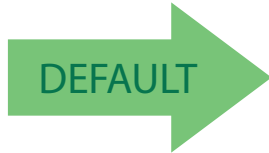

1 2 of 5 Check Char Calc = Disable



1 2 of 5 Check Char Calc = Check Standard  
(Modulo 10)



1 2 of 5 Check Char Calc = Check German Parcel



1 2 of 5 Check Char Calc = Check DHL



1 2 of 5 Check Char Calc = Check Daimler Chrysler



1 2 of 5 Check Char Calc = Check Bosch



1 2 of 5 Check Character Calculation = Check Italian Post

When disabled, any check character in label is treated as a data character.

## I 2 of 5 Check Character Transmission

Enable this option to transmit the check character along with I 2 of 5 bar code data.



This feature is valid only when I 2 of 5 Check Character Calculation is enabled.



I 2 of 5 Check Character Transmission = Don't Send



I 2 of 5 Check Character Transmission = Send



## I 2 of 5 Length Control

This feature specifies either variable length decoding or fixed length decoding for the I 2 of 5 symbology.

**Variable Length:** For variable length decoding, a minimum and maximum length may be set.

**Fixed Length:** For fixed length decoding, two different lengths may be set.

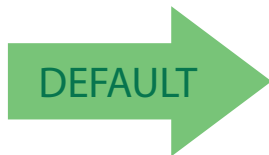

I 2 of 5 Length Control = Variable Length



I 2 of 5 Length Control = Fixed Length



## I 2 of 5 Set Length 1

This feature specifies one of the bar code lengths for I 2 of 5 Length Control on page 171. Length 1 is the minimum label length if in Variable Length on page 176 Mode, or the first fixed length if in Fixed Length on page 176 Mode. The length includes the bar code's check and data characters.

The length can be set from 2 to 50 characters in increments of two. See "Set Length 1" on page 302 for more detailed programming instructions.



Select I 2 of 5 Length 1 Setting

To configure this feature, scan the ENTER/EXIT bar code above, then the bar code at left followed by digits from the Alphanumeric characters in [Appendix D, Keypad](#) representing your desired character(s). End by scanning the ENTER/EXIT bar code again.

Make a mistake? Scan the CANCEL bar code to abort and not save the entry string. You can then start again at the beginning.

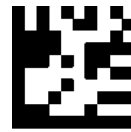

CANCEL

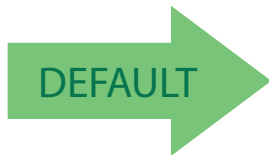

**06 = Length 1 is 6 Characters**

## I 2 of 5 Set Length 2

This feature specifies one of the bar code lengths for **I 2 of 5 Length Control** on page 171. Length 2 is the maximum label length if in **Variable Length** on page 176 Mode, or the second fixed length if in **Fixed Length** on page 176 Mode. The length includes the bar code's check and data characters.

The length can be set from 2 to 50 characters. A setting of 0 specifies to ignore this length (only one fixed length). See "**Set Length 2**" on page 303 for more detailed programming instructions.



Select I 2 of 5 Length 2 Setting

To configure this feature, scan the ENTER/EXIT bar code above, then the bar code at left followed by digits from the Alphanumeric characters in **Appendix D, Keypad** representing your desired character(s). End by scanning the ENTER/EXIT bar code again.

Make a mistake? Scan the CANCEL bar code to abort and not save the entry string. You can then start again at the beginning.

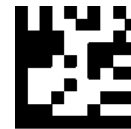

CANCEL

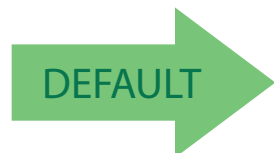

**50 = Length 2 is 50 Characters**



## Interleaved 2 of 5 CIP HR

The following options apply to the Interleaved 2 of 5 CIP HR symbology.

### Interleaved 2 of 5 CIP HR Enable/Disable

Enables/Disables ability of scanner to decode Interleaved 2 of 5 CIP HR labels.

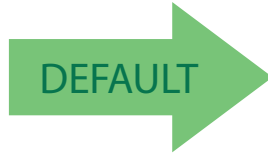

Interleaved 2 of 5 CIP HR = Disable



Interleaved 2 of 5 CIP HR = Enable

## Datalogic 2 of 5

The following options apply to the Datalogic 2 of 5 symbology.

### Datalogic 2 of 5 Enable/Disable

When disabled, the scanner will not read Datalogic 2 of 5 bar codes.

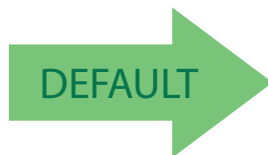

Datalogic 2 of 5 = Disable



Datalogic 2 of 5 = Enable



## Datalogic 2 of 5 Check Character Calculation

This option enables/disables calculation and verification of an optional Datalogic 2 of 5 check character.

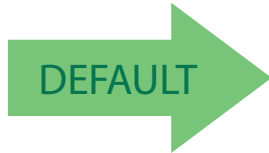

Datalogic 2 of 5 Check Character Calculation = Disable



Datalogic 2 of 5 Check Character Calculation = Enable

## Datalogic 2 of 5 Check Character Transmission

This option enables/disables transmission of an optional Datalogic 2 of 5 character.



Datalogic 2 of 5 Check Character Transmission = Don't Send



Datalogic 2 of 5 Check Character Transmission = Send





## Datalogic 2 of 5 Length Control

This feature specifies either variable length decoding or fixed length decoding for the Datalogic 2 of 5 symbology.

**Variable Length:** For variable length decoding, a minimum and maximum length may be set.

**Fixed Length:** For fixed length decoding, two different lengths may be set.

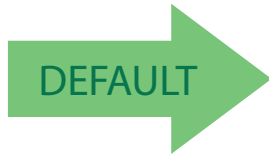

Datalogic 2 of 5 Length Control = Variable Length



Datalogic 2 of 5 Length Control = Fixed Length

## Datalogic 2 of 5 Set Length 1

This feature specifies one of the bar code lengths for [Datalogic 2 of 5 Length Control on page 176](#). Length 1 is the minimum label length if in [Variable Length on page 171 Mode](#), or the first fixed length if in [Fixed Length on page 171 Mode](#). The length includes the bar code's data characters only.

The length can be set from 2 to 50 characters in increments of two. See "[Set Length 1](#)" on page 302 for more detailed programming instructions.



Select Datalogic 2 of 5 Length 1 Setting

To configure this feature, scan the ENTER/EXIT bar code above, then the bar code at left followed by digits from the Alphanumeric characters in [Appendix D, Keypad](#) representing your desired character(s). End by scanning the ENTER/EXIT bar code again.

Make a mistake? Scan the CANCEL bar code to abort and not save the entry string. You can then start again at the beginning.

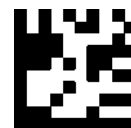

CANCEL

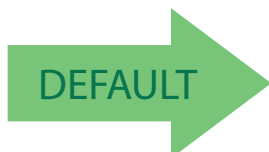

**06 = Length 1 is 6 Characters**

## Datalogic 2 of 5 Set Length 2

This feature specifies one of the bar code lengths for **Datalogic 2 of 5 Length Control** on page 176. Length 2 is the maximum label length if in **Variable Length** on page 171 Mode, or the second fixed length if in **Fixed Length** on page 171 Mode. The length includes the bar code's data characters only.

The length can be set from 2 to 50 characters. A setting of 00 specifies to ignore this length (only one fixed length). See "**Set Length 2**" on page 303 for more detailed programming instructions.



Select Datalogic 2 of 5 Length 2 Setting

To configure this feature, scan the ENTER/EXIT bar code above, then the bar code at left followed by digits from the Alphanumeric characters in **Appendix D, Keypad** representing your desired character(s). End by scanning the ENTER/EXIT bar code again.

Make a mistake? Scan the CANCEL bar code to abort and not save the entry string. You can then start again at the beginning.

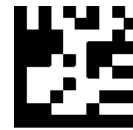

CANCEL

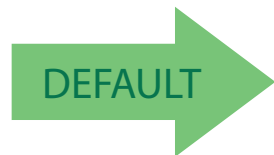

**50 = Length 2 is 50 Characters**



## Codabar

The following options apply to the Codabar symbology.

### Codabar Enable/Disable

When disabled, the scanner will not read Codabar bar codes.

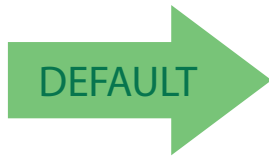

Codabar = Disable



Codabar = Enable

### Codabar Check Character Calculation

Enable this option to enables/disables calculation and verification of an optional Codabar check character. When disabled, any check characters in the label are treated as data characters.

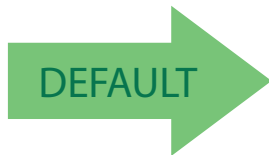

Codabar Check Character Calculation = Don't Calculate



Codabar Check Character Calculation = Enable AIM standard check char.



Codabar Check Character Calculation = Enable Modulo 10 check char.

## Codabar Check Character Transmission

Enable this option to transmit the check character along with Codabar bar code data.



**NOTE**

This feature is valid only when Codabar Check Character Calculation is enabled.



Codabar Check Character Transmission = Don't Send



Codabar Check Character Transmission = Send



## Codabar Start/Stop Character Transmission

Enable this option to enable/disable transmission of Codabar start and stop characters.



Codabar Start/Stop Character Transmission = Don't Transmit



Codabar Start/Stop Character Transmission = Transmit





## Codabar Start/Stop Character Set

This option specifies the format of transmitted Codabar start/stop characters.



Codabar Check Character Set = ABCD/TN\*E



Codabar Check Character Set = ABCD/ABCD



Codabar Check Character Set = abcd/tn\*e



Codabar Check Character Set = abcd/abcd



## Codabar Start/Stop Character Match

When enabled, this option requires that start and stop characters match.

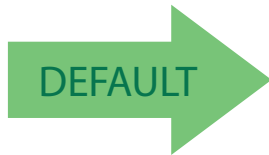

Codabar Start/Stop Character Match = Don't Require Match



Codabar Start/Stop Character Match = Require Match

## Codabar Quiet Zones

This feature specifies the number of quiet zones for Codabar labels. Quiet zones are blank areas at the ends of a bar code and are typically 10 times the width of the narrowest bar or space in the label.



Codabar Quiet Zones = Quiet Zone on one side



Codabar Quiet Zones = Quiet Zones on two sides



Codabar Quiet Zones = Auto



Codabar Quiet Zones = Virtual Quiet Zones on two sides



Codabar Quiet Zones = Small Quiet Zones on two sides



### Codabar Length Control

This feature specifies either variable length decoding or fixed length decoding for the Codabar symbology.

**Variable Length:** For variable length decoding, a minimum and maximum length may be set.

**Fixed Length:** For fixed length decoding, two different lengths may be set.

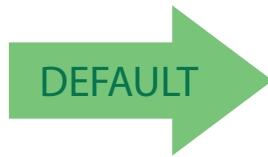

Codabar Length Control = Variable Length



Codabar Length Control = Fixed Length

### Codabar Set Length 1

This feature specifies one of the bar code lengths for **Codabar Length Control** on page 182. Length 1 is the minimum label length if in **Variable Length** on page 182 Mode, or the first fixed length if in **Fixed Length** on page 182 Mode. Length includes the bar code's start, stop, check and data characters. The length must include at least one data character.

The length can be set from 3 to 50 characters. See "**Set Length 1**" on page 302 for more detailed programming instructions.



Select Codabar Length 1 Setting

To configure this feature, scan the ENTER/EXIT bar code above, then the bar code at left followed by digits from the Alphanumeric characters in **Appendix D, Keypad** representing your desired character(s). End by scanning the ENTER/EXIT bar code again.

Make a mistake? Scan the CANCEL bar code to abort and not save the entry string. You can then start again at the beginning.

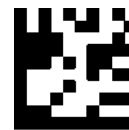

CANCEL

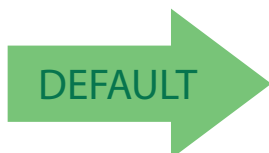

**03 = Length 1 is 3 Characters**



## Codabar Set Length 2

This feature specifies one of the bar code lengths for [Codabar Length Control on page 182](#). Length 2 is the maximum label length if in [Variable Length on page 182 Mode](#), or the second fixed length if in [Fixed Length on page 182 Mode](#). The length includes the bar code's start, stop, check and data characters. The length must include at least one data character.

The length can be set from 3 to 50 characters. A setting of 00 specifies to ignore this length (only one fixed length). See ["Set Length 2" on page 303](#) for more detailed programming instructions.



Select Codabar Length 2 Setting

To configure this feature, scan the ENTER/EXIT bar code above, then the bar code at left followed by digits from the Alphanumeric characters in [Appendix D, Keypad](#) representing your desired character(s). End by scanning the ENTER/EXIT bar code again.

Make a mistake? Scan the CANCEL bar code to abort and not save the entry string. You can then start again at the beginning.



CANCEL

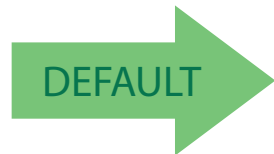

**50 = Length 2 is 50 Characters**



## ABC Codabar

The following options apply to the ABC Codabar symbology.

### ABC Codabar Enable/Disable

Enables/Disables ability of scanner to decode ABC Codabar labels.

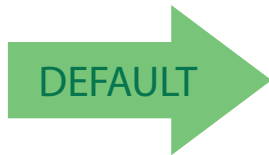

ABC Codabar = Disable



ABC Codabar = Enable

### ABC Codabar Concatenation Mode

Specifies the concatenation mode between Static and Dynamic.

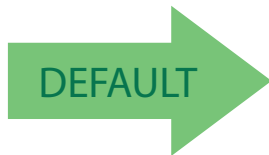

ABC Codabar Concatenation Mode = Static



ABC Codabar Concatenation Mode = Dynamic



## ABC Codabar Dynamic Concatenation Timeout

This parameter specifies the timeout in 10–millisecond ticks used by the ABC Codabar Dynamic Concatenation Mode. The timeout can be set within a range of 05 to 255 in 10ms increments. A setting of zero specifies no delay.



Select ABC Codabar Dynamic Concatenation Timeout Setting

To configure this feature, scan the ENTER/EXIT bar code above, then the bar code at left followed by digits from the Alphanumeric characters in [Appendix D, Keypad](#) representing your desired character(s). End by scanning the ENTER/EXIT bar code again.

Make a mistake? Scan the CANCEL bar code to abort and not save the entry string. You can then start again at the beginning.



CANCEL

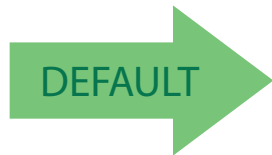

10 = Quiet Interval of 200 ms

## ABC Codabar Force Concatenation

When ABC Codabar Concatenation is enabled and Force Concatenation is disabled, both Codabar stand alone labels and ABC Codabar concatenated labels are transmitted. When ABC Codabar Concatenation is enabled and Force Concatenation is enabled only ABC Codabar concatenated labels are transmitted while Codabar stand alone labels are not transmitted.

Force Concatenation has no effect if the ABC Codabar Concatenation is disabled. The Force Concatenation mode has effect both in Static and Dynamic Concatenation Modes.

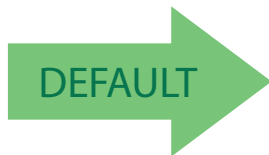

ABC Codabar Force Concatenation = Disable



ABC Codabar Force Concatenation = Enable



## Code 11

The following options apply to the Code 11 symbology.

### Code 11 Enable/Disable

When disabled, the scanner will not read Code 11 bar codes.

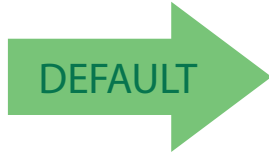

Code 11 = Disable



Code 11 = Enable

### Code 11 Check Character Calculation

This option enables/disables calculation and verification of optional Code 11 check character.



Code 11 Check Character Calculation = Disable



Code 11 Check Character Calculation = Check C



Code 11 Check Character Calculation = Check K



Code 11 Check Character Calculation = Check C and K



## Code 11 Check Character Transmission

This feature enables/disables transmission of an optional Code 11 check character.



Code 11 Check Character Transmission = Don't Send



Code 11 Check Character Transmission = Send



## Code 11 Length Control

This feature specifies either variable length decoding or fixed length decoding for the Code 11 symbology.

**Variable Length:** For variable length decoding, a minimum and maximum length may be set.

**Fixed Length:** For fixed length decoding, two different lengths may be set.



Code 11 Length Control = Variable Length



Code 11 Length Control = Fixed Length



## Code 11 Set Length 1

This feature specifies one of the bar code lengths for **Code 11 Length Control on page 187**. Length 1 is the minimum label length if in **Variable Length on page 187 Mode**, or the first fixed length if in **Fixed Length on page 187 Mode**. Length includes the bar code's check and data characters.

The length can be set from 2 to 50 characters. See "**Set Length 1**" on page 302 for more detailed programming instructions.



Select Code 11 Set Length 1 Setting

To configure this feature, scan the ENTER/EXIT bar code above, then the bar code at left followed by digits from the Alphanumeric characters in **Appendix D, Keypad** representing your desired character(s). End by scanning the ENTER/EXIT bar code again.

Make a mistake? Scan the CANCEL bar code to abort and not save the entry string. You can then start again at the beginning.

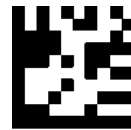

CANCEL

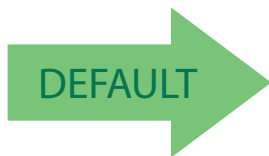

**04 = Length 1 is 4 Characters**

## Code 11 Set Length 2

This feature specifies one of the bar code lengths for [Code 11 Length Control on page 187](#). Length 2 is the maximum label length if in [Variable Length on page 187 Mode](#), or the second fixed length if in [Fixed Length on page 187 Mode](#). Length includes the bar code's check and data characters.

The length can be set from 2 to 50 characters. A setting of 00 specifies to ignore this length (only one fixed length). See ["Set Length 2" on page 303](#) for more detailed programming instructions.



Select Code 11 Length 2 Setting

To configure this feature, scan the ENTER/EXIT bar code above, then the bar code at left followed by digits from the Alphanumeric characters in [Appendix D, Keypad](#) representing your desired character(s). End by scanning the ENTER/EXIT bar code again.

Make a mistake? Scan the CANCEL bar code to abort and not save the entry string. You can then start again at the beginning.



CANCEL

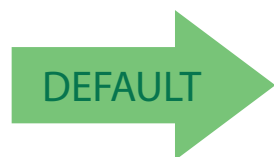

**50 = Length 2 is 50 Characters**



## Standard 2 of 5

The following options apply to the Standard 2 of 5 symbology.

### Standard 2 of 5 Enable/Disable

When disabled, the scanner will not read Standard 2 of 5 bar codes.

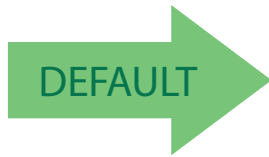

Standard 2 of 5 = Disable



Standard 2 of 5 = Enable

### Standard 2 of 5 Check Character Calculation

This option enables/disables calculation and verification of an optional Standard 2 of 5 check character.

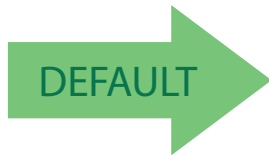

Standard 2 of 5 Check Character Calculation = Disable



Standard 2 of 5 Check Character Calculation = Enable



## Standard 2 of 5 Check Character Transmission

This feature enables/disables transmission of an optional Standard 2 of 5 check character.



Standard 2 of 5 Check Character Transmission = Don't Send



Standard 2 of 5 Check Character Transmission = Send



## Standard 2 of 5 Length Control

This feature specifies either variable length decoding or fixed length decoding for the Standard 2 of 5 symbology.

**Variable Length:** For variable length decoding, a minimum and maximum length may be set.

**Fixed Length:** For fixed length decoding, two different lengths may be set.

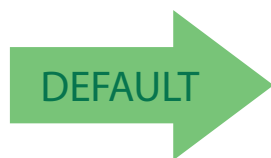

Standard 2 of 5 Length Control = Variable Length



Standard 2 of 5 Length Control = Fixed Length



## Standard 2 of 5 Set Length 1

This feature specifies one of the bar code lengths for **Standard 2 of 5 Length Control** on page 191. Length 1 is the minimum label length if in **Variable Length** on page 191 Mode, or the first fixed length if in **Fixed Length** on page 191 Mode. Length includes the bar code's check and data characters.

The length can be set from 1 to 50 characters. See "**Set Length 1**" on page 302 for more detailed programming instructions.



Select Standard 2 of 5 Length 1 Setting

To configure this feature, scan the ENTER/EXIT bar code above, then the bar code at left followed by digits from the Alphanumeric characters in **Appendix D, Keypad** representing your desired character(s). End by scanning the ENTER/EXIT bar code again.

Make a mistake? Scan the CANCEL bar code to abort and not save the entry string. You can then start again at the beginning.



CANCEL

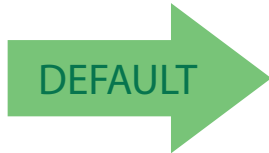

**08 = Length 1 is 8 Characters**

## Standard 2 of 5 Set Length 2

This feature specifies one of the bar code lengths for **Standard 2 of 5 Length Control** on page 191. Length 2 is the maximum label length if in **Variable Length** on page 191 Mode, or the second fixed length if in **Fixed Length** on page 191 Mode. Length includes the bar code's check and data characters. The length can be set from 1 to 50 characters. A setting of 00 specifies to ignore this length (only one fixed length). See "**Set Length 2**" on page 303 for more detailed programming instructions.

W5212



Select Standard 2 of 5 Length 2 Setting

To configure this feature, scan the ENTER/EXIT bar code above, then the bar code at left followed by digits from the Alphanumeric characters in **Appendix D, Keypad** representing your desired character(s). End by scanning the ENTER/EXIT bar code again.

Make a mistake? Scan the CANCEL bar code to abort and not save the entry string. You can then start again at the beginning.

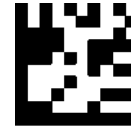

CANCEL

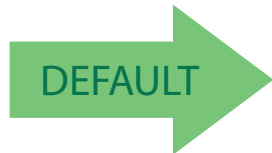

**50 = Length 2 is 50 Characters**



## Industrial 2 of 5

The following options apply to the Industrial 2 of 5 symbology.

### Industrial 2 of 5 Enable/Disable

Enables/Disables ability of scanner to decode Industrial 2 of 5 labels.

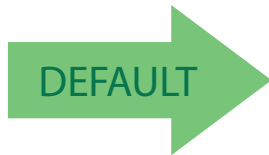

Industrial 2 of 5 = Disable



Industrial 2 of 5 = Enable

### Industrial 2 of 5 Check Character Calculation

Enables/Disables calculation and verification of an optional Industrial 2 of 5 check character.

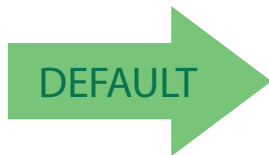

Industrial 2 of 5 Check Character Calculation = Disable



Industrial 2 of 5 Check Character Calculation = Enable

## Industrial 2 of 5 Check Character Transmission

Enables/disables transmission of an Industrial 2 of 5 check character.

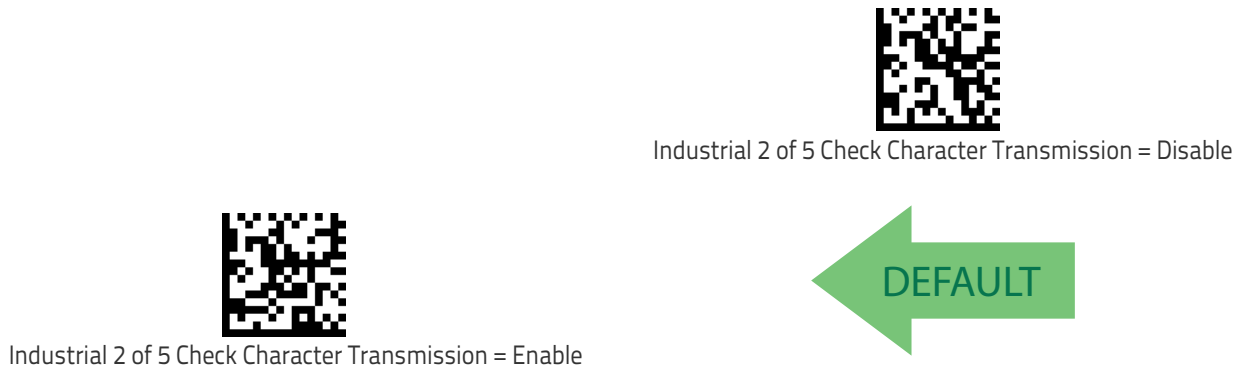

## Industrial 2 of 5 Length Control

This feature specifies either variable length decoding or fixed length decoding for the Industrial 2 of 5 symbology.

**Variable Length:** For variable length decoding, a minimum and maximum length may be set.

**Fixed Length:** For fixed length decoding, two different lengths may be set.

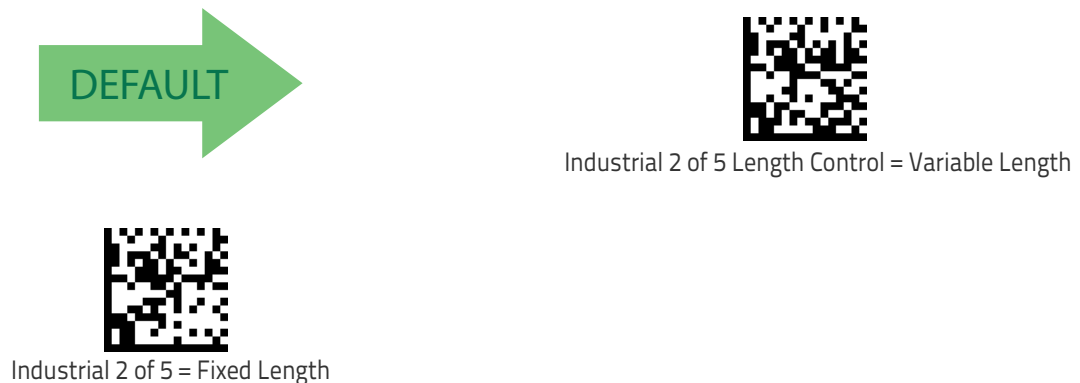



## Industrial 2 of 5 Set Length 1

This feature specifies one of the bar code lengths for **Industrial 2 of 5 Length Control** on page 195. Length 1 is the minimum label length if in **Variable Length** on page 158 Mode, or the first fixed length if in **Fixed Length** on page 158 Mode. Length includes the bar code's data characters only.

The length can be set from 1 to 50 characters. See "**Set Length 1**" on page 302 for more detailed programming instructions.



Select Industrial 2 of 5 Set Length 1 Setting

To configure this feature, scan the ENTER/EXIT bar code above, then the bar code at left followed by digits from the Alphanumeric characters in **Appendix D, Keypad** representing your desired character(s). End by scanning the ENTER/EXIT bar code again.

Make a mistake? Scan the CANCEL bar code to abort and not save the entry string. You can then start again at the beginning.

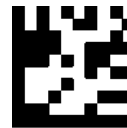

CANCEL



**01 = Length 1 is 1 Character**

## Industrial 2 of 5 Set Length 2

This feature specifies one of the bar code lengths for **Industrial 2 of 5 Length Control** on page 195. Length 2 is the maximum label length if in **Variable Length** on page 158 Mode, or the second fixed length if in **Fixed Length** on page 158 Mode. Length includes the bar code's check, data, and full-ASCII shift characters. The length does not include start/stop characters.

The length can be set from 1 to 50 characters. A setting of 00 specifies to ignore this length (only one fixed length). See "**Set Length 2**" on page 303 for more detailed programming instructions.



Select Industrial 2 of 5 Length 2 Setting

To configure this feature, scan the ENTER/EXIT bar code above, then the bar code at left followed by digits from the Alphanumeric characters in **Appendix D, Keypad** representing your desired character(s). End by scanning the ENTER/EXIT bar code again.

Make a mistake? Scan the CANCEL bar code to abort and not save the entry string. You can then start again at the beginning.

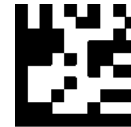

CANCEL

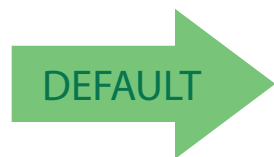

**50 = Length 2 is 50 Characters**



## IATA

The following options apply to the IATA symbology.

### IATA Enable/Disable

Enables/Disables the ability of the scanner to decode IATA labels.

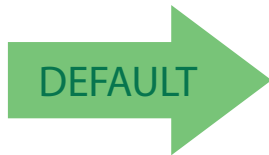

IATA = Disable



IATA = Enable

### IATA Check Character Transmission

Enables/Disables calculation and verification of an optional Industrial 2 of 5 check character.



IATA Check Character Transmission = Disable



IATA Check Character Transmission = Enable





## ISBT 128

The following options apply to the ISBT 128 symbology.

### ISBT 128 Concatenation

Enables/disables ISBT128 concatenation of 2 labels.

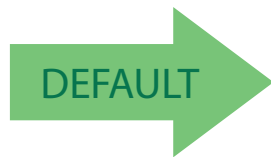

ISBT 128 Concatenation = Disable



ISBT 128 Concatenation = Enable

### ISBT 128 Concatenation Mode

Specifies the concatenation mode between Static and Dynamic.



**NOTE**

This option is only valid when ISBT 128 Concatenation on page 199 is enabled (see page 11-199).

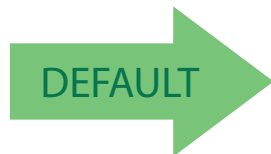

ISBT 128 Concatenation Mode = Static



ISBT 128 Concatenation Mode = Dynamic



## ISBT 128 Dynamic Concatenation Timeout

Specifies the timeout used by the ISBT 128 Dynamic Concatenation Mode.



ISBT 128 Dynamic Concatenation Timeout = 50 msec



ISBT 128 Dynamic Concatenation Timeout = 100 msec

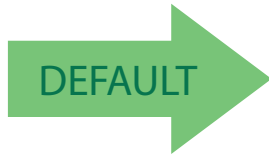

ISBT 128 Dynamic Concatenation Timeout = 200 msec



ISBT 128 Dynamic Concatenation Timeout = 500 msec



ISBT 128 Dynamic Concatenation Timeout = 750 msec



ISBT 128 Dynamic Concatenation Timeout = 1 second

## ISBT 128 Force Concatenation

When enabled, this feature forces all ISBT 128 labels to be concatenated.



**NOTE**

This option is only valid when ISBT 128 Concatenation on page 199 is enabled. (see page 11-199).

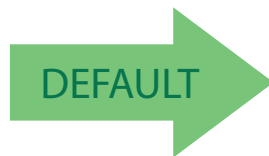

ISBT 128 Force Concatenation = Disable



ISBT 128 Force Concatenation = Enable

## ISBT 128 Advanced Concatenation Options



**NOTE**

Use the Datalogic Aladdin configuration application or Contact Customer Support to set up pairs of label types for concatenation.



## MSI

The following options apply to the MSI symbology.

### MSI Enable/Disable

Enables/Disables ability of scanner to decode MSI labels.

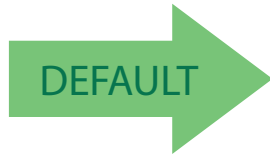

MSI = Disable



MSI = Enable

### MSI Check Character Calculation

Enables/Disables calculation and verification of an optional MSI check character.



MSI Check Character Calculation = Disable



MSI Check Character Calculation = Enable Mod10



MSI Check Character Calculation = Enable Mod11/10



MSI Check Character Calculation = Enable Mod10/10

## MSI Check Character Transmission

Enables/disables transmission of an MSI check character.

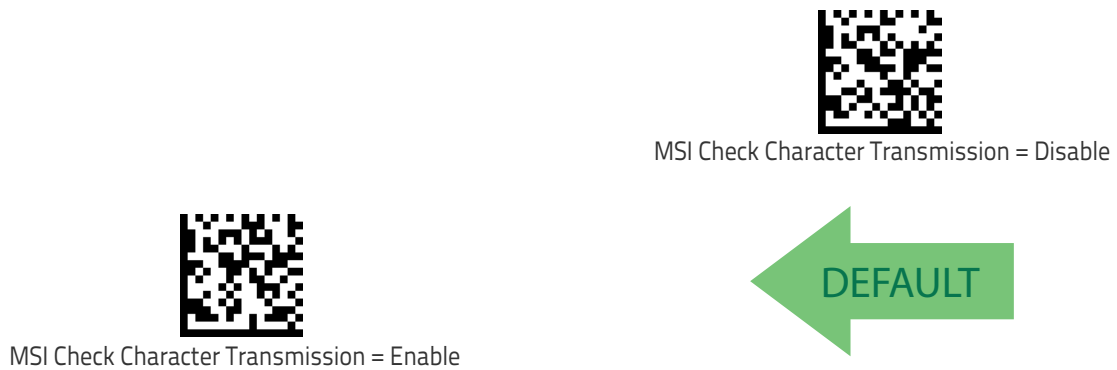

## MSI Length Control

This feature specifies either variable length decoding or fixed length decoding for the MSI symbology.

**Variable Length:** For variable length decoding, a minimum and maximum length may be set.

**Fixed Length:** For fixed length decoding, two different lengths may be set.

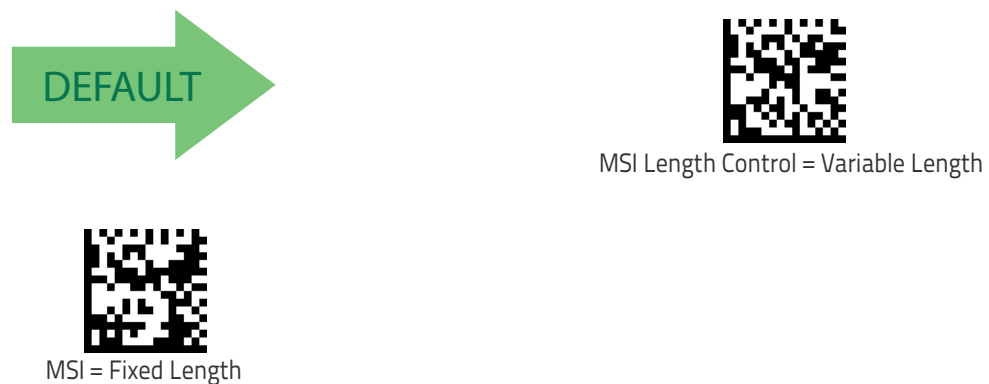



## MSI Set Length 1

This feature specifies one of the bar code lengths for **MSI Length Control** on page 203. Length 1 is the minimum label length if in **Variable Length** on page 203 Mode, or the first fixed length if in **Fixed Length** on page 203 Mode. Length includes the bar code's data characters only.

The length can be set from 01 to 50 characters. See "Set Length 1" on page 302 for more detailed programming instructions.



Select MSI Set Length 1 Setting

To configure this feature, scan the ENTER/EXIT bar code above, then the bar code at left followed by digits from the Alphanumeric characters in **Appendix D, Keypad** representing your desired character(s). End by scanning the ENTER/EXIT bar code again.

Make a mistake? Scan the CANCEL bar code to abort and not save the entry string. You can then start again at the beginning.

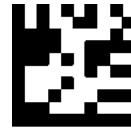

CANCEL

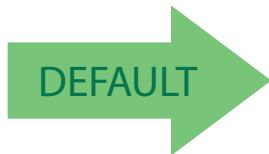

**01 = Length 1 is 1 Character**

## MSI Set Length 2

This feature specifies one of the bar code lengths for [MSI Length Control on page 203](#). Length 2 is the maximum label length if in [Variable Length on page 203 Mode](#), or the second fixed length if in [Fixed Length on page 203 Mode](#). Length includes the bar code's check, data, and full-ASCII shift characters. The length does not include start/stop characters.

The length can be set from 1 to 50 characters. A setting of 0 specifies to ignore this length (only one fixed length). See ["Set Length 2" on page 303](#) for more detailed programming instructions.



Select MSI Length 2 Setting

To configure this feature, scan the ENTER/EXIT bar code above, then the bar code at left followed by digits from the Alphanumeric characters in [Appendix D, Keypad](#) representing your desired character(s). End by scanning the ENTER/EXIT bar code again.

Make a mistake? Scan the CANCEL bar code to abort and not save the entry string. You can then start again at the beginning.

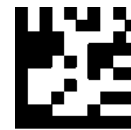

CANCEL

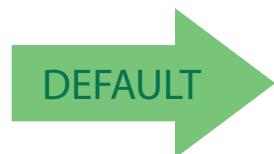

**50 = Length 2 is 50 Characters**



## Code 93

The following options apply to the Code 93 symbology.

### Code 93 Enable/Disable

Enables/Disables ability of scanner to decode Code 93 labels.

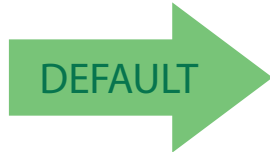

Code 93 = Disable



Code 93 = Enable

### Code 93 Check Character Calculation

Enables/disables calculation and verification of an optional Code 93 check character.



Code 93 Check Character Calculation = Disable



Code 93 Check Character Calculation = Enable Check C



Code 93 Check Character Calculation = Enable Check K



Code 93 Check Character Calculation = Enable Check C and K





## Code 93 Check Character Transmission

Enables/disables transmission of an optional Code 93 check character.

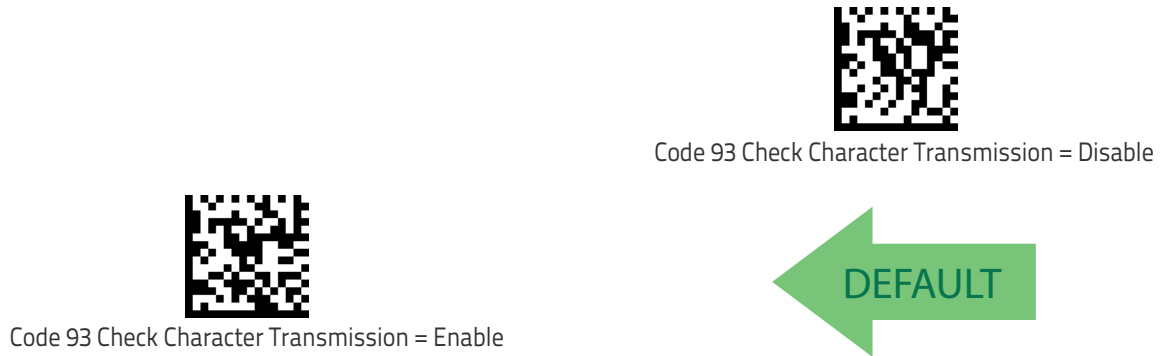

## Code 93 Length Control

This feature specifies either variable length decoding or fixed length decoding for the Code 93 symbology.

**Variable Length:** For variable length decoding, a minimum and maximum length may be set.

**Fixed Length:** For fixed length decoding, two different lengths may be set.





## Code 93 Set Length 1

This feature specifies one of the bar code lengths for [Code 93 Length Control on page 207](#). Length 1 is the minimum label length if in [Variable Length on page 207 Mode](#), or the first fixed length if in [Fixed Length on page 207 Mode](#). Length includes the bar code's data characters only.

The length can be set from 01 to 50 characters. See "[Set Length 1](#)" on page 302 for more detailed programming instructions.



Select Code 93 Set Length 1 Setting

To configure this feature, scan the ENTER/EXIT bar code above, then the bar code at left followed by digits from the Alphanumeric characters in [Appendix D, Keypad](#) representing your desired character(s). End by scanning the ENTER/EXIT bar code again.

Make a mistake? Scan the CANCEL bar code to abort and not save the entry string. You can then start again at the beginning.

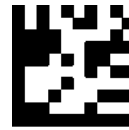

CANCEL

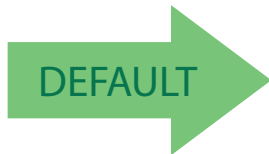

**01 = Length 1 is 1 Character**

## Code 93 Set Length 2

This feature specifies one of the bar code lengths for [Code 93 Length Control on page 207](#). Length 2 is the maximum label length if in [Variable Length on page 207 Mode](#), or the second fixed length if in [Fixed Length on page 207 Mode](#). Length includes the bar code's check, data, and full-ASCII shift characters. The length does not include start/stop characters.

The length can be set from 1 to 50 characters. A setting of 00 specifies to ignore this length (only one fixed length). See ["Set Length 2" on page 303](#) for more detailed programming instructions.



Select Code 93 Length 2 Setting

To configure this feature, scan the ENTER/EXIT bar code above, then the bar code at left followed by digits from the Alphanumeric characters in [Appendix D, Keypad](#) representing your desired character(s). End by scanning the ENTER/EXIT bar code again.

Make a mistake? Scan the CANCEL bar code to abort and not save the entry string. You can then start again at the beginning.

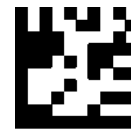

CANCEL



**50 = Length 2 is 50 Characters**



## Code 93 Quiet Zones

Enables/disables fixed length stitching for Code 93.



**NOTE**

This feature is available only on the TD1130 model.



Code 93 Quiet Zones = No Quiet Zones



Code 93 Quiet Zones = Quiet Zone on one side



Code 93 Quiet Zones = Quiet Zones on two sides



Code 93 Quiet Zones = Auto



Code 93 Quiet Zones = Virtual Quiet Zones on two sides

## Follett 2 of 5

The following options apply to the Follett 2 of 5 symbology.

### Follett 2 of 5 Enable/Disable

Enables/Disables ability of scanner to decode Follett 2 of 5 labels.

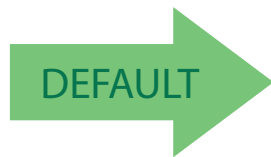

Follett 2 of 5 = Disable



Follett 2 of 5 = Enable

## BC412

The following options apply to the BC412 symbology.

### BC412 Enable/Disable

Enables/Disables ability of scanner to decode BC412 labels.

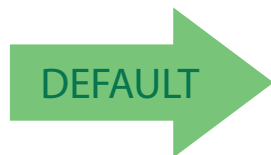

BC412 = Disable



BC412 = Enable



## BC412 Check Character Calculation

Enable this option to enable/disable calculation and verification of an optional BC412 check character. When disabled, any check character in the label is treated as a data character.

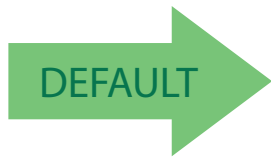

BC412 Check Character Calculation = Don't Calculate



BC412 Check Character Calculation = Calculate Check Character

## BC412 Length Control

This feature specifies either variable length decoding or fixed length decoding for the BC412 symbology.

**Variable Length:** For variable length decoding, a minimum and maximum length may be set.

**Fixed Length:** For fixed length decoding, two different lengths may be set.

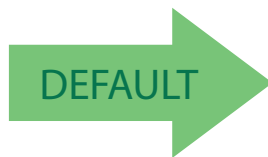

BC412 Length Control = Variable Length



BC412 Length Control = Fixed Length

## BC412 Set Length 1

This feature specifies one of the bar code lengths for **BC412 Length Control** on page 212. Length 1 is the minimum label length if in **Variable Length** on page 212 Mode, or the first fixed length if in **Fixed Length** on page 212 Mode. Length includes the bar code's data characters only.

The length can be set from 01 to 50 characters. See "Set Length 1" on page 302 for more detailed programming instructions.

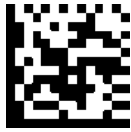

Select BC412 Set Length 1 Setting

To configure this feature, scan the ENTER/EXIT bar code above, then the bar code at left followed by digits from the Alphanumeric characters in **Appendix D, Keypad** representing your desired character(s). End by scanning the ENTER/EXIT bar code again.

Make a mistake? Scan the CANCEL bar code to abort and not save the entry string. You can then start again at the beginning.

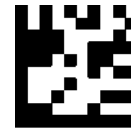

CANCEL

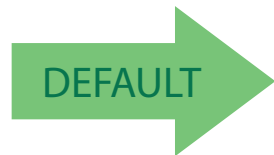

01 = Length 1 is 1 Character



## BC412 Set Length 2

This feature specifies one of the bar code lengths for BC412 Length Control on page 212. Length 2 is the maximum label length if in Variable Length on page 212 Mode, or the second fixed length if in Fixed Length on page 212 Mode. Length includes the bar code’s check, data, and full-ASCII shift characters. The length does not include start/stop characters.

The length can be set from 1 to 50 characters. A setting of 00 specifies to ignore this length (only one fixed length). See "Set Length 2" on page 303 for more detailed programming instructions.

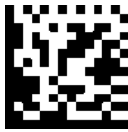

Select BC412 Length 2 Setting

To configure this feature, scan the ENTER/EXIT bar code above, then the bar code at left followed by digits from the Alphanumeric characters in Appendix D, Key-pad representing your desired character(s). End by scanning the ENTER/EXIT bar code again.

Make a mistake? Scan the CANCEL bar code to abort and not save the entry string. You can then start again at the beginning.

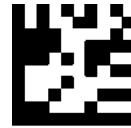

CANCEL

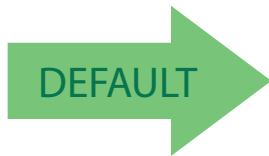

**50 = Length 2 is 50 Characters**



## 2D Symbologies

2D Global Features	
▪ <b>2D MAXIMUM DECODING TIME</b> on page 216	▪ <b>2D NORMAL/INVERSE SYMBOL CONTROL</b> on page 217
▪ <b>2D STRUCTURED APPEND</b> on page 217	

The reader supports the following 2D symbologies (bar code types). Symbology-dependent options for each symbology are included in this chapter. See "1D Symbologies" starting on page 113 for configuration of 1D bar codes.

2D Symbologies	
▪ <b>AZTEC CODE</b> on page 218	▪ <b>MICRO PDF417</b> on page 233
▪ <b>CHINA SENSIBLE CODE</b> on page 221	▪ <b>QR CODE</b> on page 236
▪ <b>DATA MATRIX</b> on page 224	▪ <b>MICRO QR CODE</b> on page 239
▪ <b>MAXICODE</b> on page 227	▪ <b>UCC COMPOSITE</b> on page 242
▪ <b>PDF417</b> on page 230	▪ <b>POSTAL CODE SELECTION</b> on page 243

## 2D Global Features

The following features are common to all, or in some cases, most of the available 2D symbologies. Default settings are indicated at each feature/option with a green arrow. Also reference [Appendix B, Standard Defaults](#) for a listing of the most widely used set of standard factory settings. That section also provides space to record any custom settings needed or implemented for your system.

To set most features:

1. Scan the ENTER/EXIT PROGRAMMING bar code at the top of applicable programming pages.
2. Scan the correct bar code to set the desired programming feature or parameter. You may need to cover unused bar codes on the page, and possibly the facing page, to ensure that the reader reads only the bar code you intend to scan.
3. If additional input parameters are needed, go to [Appendix D, Keypad](#), and scan the appropriate characters from the keypad.



**NOTE**

Additional information about many features can be found in the "References" chapter.

If you make a mistake before the last character, scan the CANCEL bar code to abort and not save the entry string. You can then start again at the beginning.

Complete the programming sequence by scanning the ENTER/EXIT PROGRAMMING bar code to exit Programming Mode.



## 2D Maximum Decoding Time

This feature specifies the maximum amount of time the software will spend attempting to decode a 2D label. The selectable range is 10 milliseconds to 2.55 milliseconds.



2D Maximum Decoding Time = 100 msec



2D Maximum Decoding Time = 200 msec



2D Maximum Decoding Time = 350 msec



2D Maximum Decoding Time = 500 msec



2D Maximum Decoding Time = 1 Second



2D Maximum Decoding Time = 2 Seconds



2D Maximum Decoding Time = 2.55 Seconds



## 2D Structured Append

Enables/disables ability of reader to append multiple 2D Codes labels in a structured format. The structured append property is globally applied to the following symbologies, if these are enabled:

- Data Matrix
- QR Code
- Aztec
- PDF 417

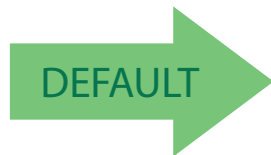

Structured Append = Disable



Structured Append = Enable

## 2D Normal/Inverse Symbol Control

Specifies the options available for decoding normal/negative printed 2D symbols. This configuration item applies globally to all the 2D symbologies that support that feature according to Standard AIM Specification: Data Matrix, QR, MicroQR, Aztec and Chinese Sensible Code.

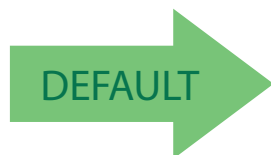

Normal/Inverse Symbol Control = Normal



Normal/Inverse Symbol Control = Inverse



Normal/Inverse Symbol Control = Both Normal and Inverse



# Symbology Selection

## Aztec Code

### Aztec Code Enable / Disable

Enables/disables the ability of the reader to decode Aztec Code labels.

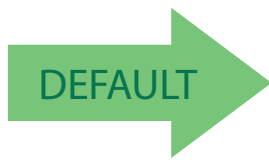

Aztec Code = Disable



Aztec Code = Enable

### Aztec Code Length Control

This feature specifies either variable length decoding or fixed length decoding for this symbology.

**Variable Length:** For variable length decoding, a minimum and maximum length may be set.

**Fixed Length:** For fixed length decoding, two different lengths may be set.

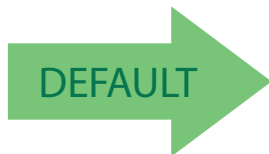

Aztec Code Length Control = Variable Length



Aztec Code Length Control = Fixed Length



## Aztec Code Set Length 1

Specifies one of the bar code lengths for [Aztec Code Length Control on page 218](#). Length 1 is the minimum label length if in [Variable Length Mode](#), or the first fixed length if in [Fixed Length Mode](#). Characters can be set from 0001 to 3,832 characters in increments of 0001 (pad with zeroes).

See [page 302](#) for detailed instructions on setting this feature.



Select Aztec Code Length 1 Setting

To configure this feature, scan the ENTER/EXIT PROGRAMMING MODE bar code above, then the bar code at left followed by the digits from the Alphanumeric characters in [Appendix D, Keypad](#) representing your desired character(s). End by scanning the ENTER/EXIT bar code again.

Make a mistake? Scan the CANCEL bar code to abort and not save the entry string. You can then start again at the beginning.



CANCEL

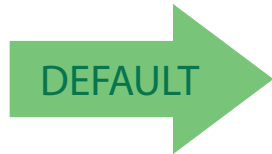

**0001 = Length 1 is 1 Character**



## Aztec Code Set Length 2

This feature specifies one of the bar code lengths for [Aztec Code Length Control on page 218](#). Length 2 is the maximum label length if in Variable Length Mode, or the second fixed length if in Fixed Length Mode. Characters can be set from 0001 to 3,832 characters in increments of 0001 (pad with zeroes).

See [page 303](#) for detailed instructions on setting this feature.



Select Aztec Code Length 2 Setting

To configure this feature, scan the ENTER/EXIT PROGRAMMING MODE bar code above, then the bar code at left followed by the digits from the Alphanumeric characters in [Appendix D, Keypad](#) representing your desired character(s). End by scanning the ENTER/EXIT bar code again.

Make a mistake? Scan the CANCEL bar code to abort and not save the entry string. You can then start again at the beginning.

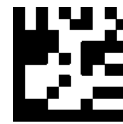

CANCEL

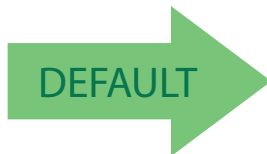

**Length 2 is 3,832 Characters**

## China Sensible Code

### China Sensible Code Enable / Disable

Enables/disables the ability of the reader to decode China Sensible Code labels.

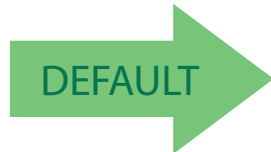

China Sensible Code = Disable



China Sensible Code = Enable

### China Sensible Code Length Control

This feature specifies either variable length decoding or fixed length decoding for this symbology.

**Variable Length:** For variable length decoding, a minimum and maximum length may be set.

**Fixed Length:** For fixed length decoding, two different lengths may be set.

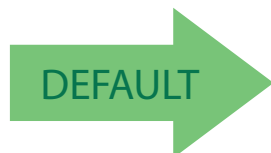

China Sensible Code Length Control = Variable Length



China Sensible Code Length Control = Fixed Length



### China Sensible Code Set Length 1

Specifies one of the bar code lengths for **China Sensible Code Length Control** on page 221. Length 1 is the minimum label length if in **Variable Length Mode**, or the first fixed length if in **Fixed Length Mode**. Characters can be set from 0001 to 7,827 characters in increments of 0001 (pad with zeroes).

See page 302 for detailed instructions on setting this feature.



Select China Sensible Code Length 1 Setting

To configure this feature, scan the ENTER/EXIT PROGRAMMING MODE bar code above, then the bar code at left followed by the digits from the Alphanumeric characters in **Appendix D, Keypad** representing your desired character(s). End by scanning the ENTER/EXIT bar code again.

Make a mistake? Scan the CANCEL bar code to abort and not save the entry string. You can then start again at the beginning.

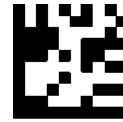

CANCEL

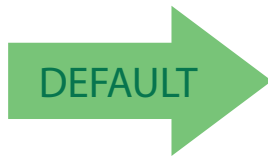

0001 = Length 1 is 1 Character





## China Sensible Code Set Length 2

This feature specifies one of the bar code lengths for [China Sensible Code Length Control on page 221](#). Length 2 is the maximum label length if in Variable Length Mode, or the second fixed length if in Fixed Length Mode. Characters can be set from 0001 to 7,827 characters in increments of 0001 (pad with zeroes).

See [page 303](#) for detailed instructions on setting this feature.



Select China Sensible Code Length 2 Setting

To configure this feature, scan the ENTER/EXIT PROGRAMMING MODE bar code above, then the bar code at left followed by the digits from the Alphanumeric characters in [Appendix D, Keypad](#) representing your desired character(s). End by scanning the ENTER/EXIT bar code again.

Make a mistake? Scan the CANCEL bar code to abort and not save the entry string. You can then start again at the beginning.



CANCEL



**Length 2 is 7,827 Characters**



## Data Matrix

### Data Matrix Enable / Disable

Enables/disables ability of reader to decode Data Matrix labels.



Data Matrix = Disable



Data Matrix = Enable



### Data Matrix Square/Rectangular Style

Specifies the options available when reading Data Matrix with different form factors. Choices are:

- Square Style
- Rectangular Style
- Both Square and Rectangular Style

The configuration item can also be configured as a bit mask to filter one or more Data Matrix labels with different symbol size AND shape styles.



Data Matrix Dimensions Mask = Square Style



Data Matrix Dimensions Mask = Rectangular Style

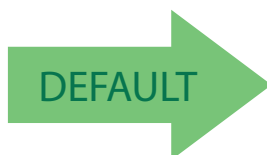

Data Matrix Dimensions Mask = Both Square and Rectangular Style



## Data Matrix Length Control

This feature specifies either variable length decoding or fixed length decoding for this symbology.

**Variable Length:** For variable length decoding, a minimum and maximum length may be set.

**Fixed Length:** For fixed length decoding, two different lengths may be set.

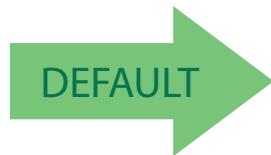

Data Matrix Length Control = Variable Length



Data Matrix Length Control = Fixed Length

## Data Matrix Set Length 1

Specifies one of the bar code lengths for [Data Matrix Length Control on page 225](#). Length 1 is the minimum label length if in [Variable Length Mode](#), or the first fixed length if in [Fixed Length Mode](#). Characters can be set from 0001 to 3,116 characters in increments of 0001 (pad with zeroes).

See [page 302](#) for detailed instructions on setting this feature.



Select Data Matrix Length 1 Setting

To configure this feature, scan the ENTER/EXIT PROGRAMMING MODE bar code above, then the bar code at left followed by the digits from the Alphanumeric characters in [Appendix D, Keypad](#) representing your desired character(s). End by scanning the ENTER/EXIT bar code again.

Make a mistake? Scan the CANCEL bar code to abort and not save the entry string. You can then start again at the beginning.



CANCEL

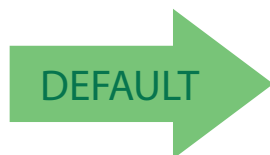

0001 = Length 1 is 1 Character



### Data Matrix Set Length 2

This feature specifies one of the bar code lengths for [Data Matrix Length Control on page 225](#). Length 2 is the maximum label length if in Variable Length Mode, or the second fixed length if in Fixed Length Mode. Characters can be set from 0001 to 3,116 characters in increments of 0001 (pad with zeroes).

See [page 303](#) for detailed instructions on setting this feature.



Select Data Matrix Length 2 Setting

To configure this feature, scan the ENTER/EXIT PROGRAMMING MODE bar code above, then the bar code at left followed by the digits from the Alphanumeric characters in [Appendix D, Keypad](#) representing your desired character(s). End by scanning the ENTER/EXIT bar code again.

Make a mistake? Scan the CANCEL bar code to abort and not save the entry string. You can then start again at the beginning.

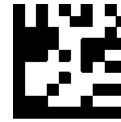

CANCEL

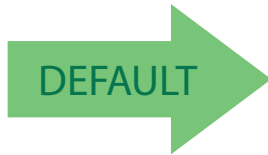

**Length 2 is 3,116 Characters**

## Maxicode

### Maxicode Enable / Disable

Enables/disables ability of reader to decode Maxicode labels.

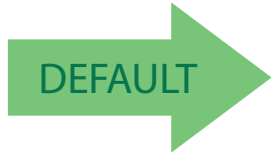

Maxicode = Disable



Maxicode = Enable

### Maxicode Primary Message Transmission

Enables/disables the transmission of only the Primary Message when the Secondary Message is not readable.

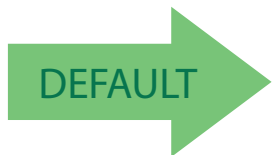

Maxicode Primary Message Transmission = Disable



Maxicode Primary Message Transmission = Enable



## Maxicode Length Control

This feature specifies either variable length decoding or fixed length decoding for this symbology.

**Variable Length:** For variable length decoding, a minimum and maximum length may be set.

**Fixed Length:** For fixed length decoding, two different lengths may be set.

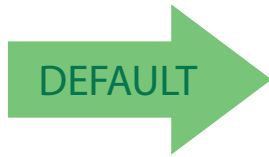

Maxicode Length Control = Variable Length



Maxicode Length Control = Fixed Length

## Maxicode Set Length 1

Specifies one of the bar code lengths for [Maxicode Length Control on page 228](#). Length 1 is the minimum label length if in [Variable Length Mode](#), or the first fixed length if in [Fixed Length Mode](#). Characters can be set from 0001 to 0145 characters in increments of 0001 (pad with zeroes).

See [page 302](#) for detailed instructions on setting this feature.



Select Maxicode Length 1 Setting

To configure this feature, scan the ENTER/EXIT PROGRAMMING MODE bar code above, then the bar code at left followed by the digits from the Alphanumeric characters in [Appendix D, Keypad](#) representing your desired character(s). End by scanning the ENTER/EXIT bar code again.

Make a mistake? Scan the CANCEL bar code to abort and not save the entry string. You can then start again at the beginning.



CANCEL

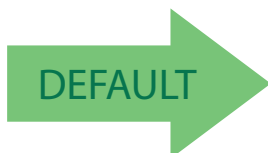

**0001 = Length 1 is 1 Character**



## Maxicode Set Length 2

This feature specifies one of the bar code lengths for [Maxicode Length Control on page 228](#). Length 2 is the maximum label length if in Variable Length Mode, or the second fixed length if in Fixed Length Mode. Characters can be set from 0001 to 0145 characters in increments of 0001 (pad with zeroes).

See [page 303](#) for detailed instructions on setting this feature.



Select Maxicode Length 2 Setting

To configure this feature, scan the ENTER/EXIT PROGRAMMING MODE bar code above, then the bar code at left followed by the digits from the Alphanumeric characters in [Appendix D, Keypad](#) representing your desired character(s). End by scanning the ENTER/EXIT bar code again.

Make a mistake? Scan the CANCEL bar code to abort and not save the entry string. You can then start again at the beginning.

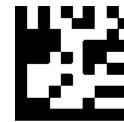

CANCEL

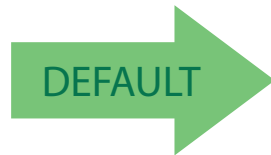

**Length 2 is 0145 Characters**



## PDF417

### PDF417 Enable / Disable

Enables/disables the ability of the reader to decode PDF417 labels.



PDF417 = Disable



PDF417 = Enable



### PDF417 Length Control

This feature specifies either variable length decoding or fixed length decoding for this symbology.

**Variable Length:** For variable length decoding, a minimum and maximum length may be set.

**Fixed Length:** For fixed length decoding, two different lengths may be set.

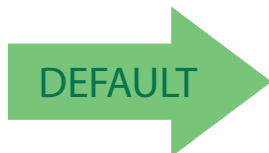

PDF417 Length Control = Variable Length



PDF417 Length Control = Fixed Length





## PDF417 Set Length 1

Specifies one of the bar code lengths for PDF417 Length Control on page 230. Length 1 is the minimum label length if in Variable Length Mode, or the first fixed length if in Fixed Length Mode. Length includes the bar code's data characters only. Characters can be set from 0001 to 2,710 characters (pad with zeroes) in increments of 01. Any value greater than 2,710 will be considered to be 2,710.

See [page 302](#) for detailed instructions on setting this feature.



Select PDF417 Length 1 Setting

To configure this feature, scan the ENTER/EXIT PROGRAMMING MODE bar code above, then the bar code at left followed by the digits from the Alphanumeric characters in [Appendix D, Keypad](#) representing your desired character(s). End by scanning the ENTER/EXIT bar code again.

Make a mistake? Scan the CANCEL bar code to abort and not save the entry string. You can then start again at the beginning.

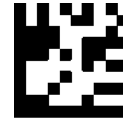

CANCEL

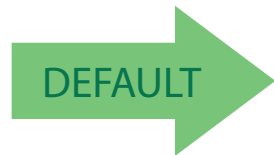

0001 = Length 1 is 1 Character



### PDF417 Set Length 2

This feature specifies one of the bar code lengths for PDF417 Length Control on page 230. Length 2 is the maximum label length if in Variable Length Mode, or the second fixed length if in Fixed Length Mode. Length includes the bar code’s check, data, and full-ASCII shift characters. The length does not include start/stop characters. Characters can be set from 01 to 2,710 characters (pad with zeroes) in increments of 01. Any value greater than 2,710 will be considered to be 2,710.

See page 303 for detailed instructions on setting this feature.



Select PDF417 Length 2 Setting

To configure this feature, scan the ENTER/EXIT PROGRAMMING MODE bar code above, then the bar code at left followed by the digits from the Alphanumeric characters in Appendix D, Keypad representing your desired character(s). End by scanning the ENTER/EXIT bar code again.

Make a mistake? Scan the CANCEL bar code to abort and not save the entry string. You can then start again at the beginning.

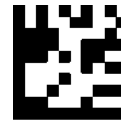

CANCEL

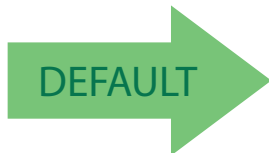

Length 2 is 2,710 Characters

## Micro PDF417

### Micro PDF417 Enable / Disable

Enables/disables the ability of the reader to decode Micro PDF417 labels.

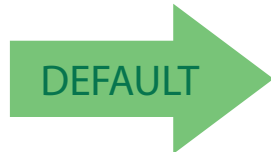

Micro PDF417 = Disable



Micro PDF417 = Enable

### Micro PDF417 Code 128 GS1-128 Emulation

Specifies which AIM ID to use for MicroPDF labels when doing Code 128 or GS1-128 emulation.

Emulation choices are:

- Micro PDF AIM ID and label type
- Code 128 / EAN128 AIM Id and label type

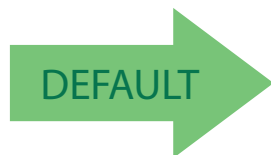

Micro PDF417 Code 128 GS1-128 Emulation =  
Micro PDF AIM ID and label type



Micro PDF417 Code 128 GS1-128 Emulation =  
Code 128 / EAN128 AIM ID and label type



## Micro PDF417 Length Control

This feature specifies either variable length decoding or fixed length decoding for this symbology.

**Variable Length:** For variable length decoding, a minimum and maximum length may be set.

**Fixed Length:** For fixed length decoding, two different lengths may be set.

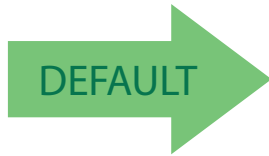

Micro PDF417 Length Control = Variable Length



Micro PDF417 Length Control = Fixed Length

## Micro PDF417 Set Length 1

Specifies one of the bar code lengths for [Micro PDF417 Length Control on page 234](#). Length 1 is the minimum label length if in [Variable Length Mode](#), or the first fixed length if in [Fixed Length Mode](#). Length includes the bar code's data characters only. Characters can be set from 0001 to 0366 characters (pad with zeroes) in increments of 01. Any value greater than 0366 will be considered to be 0366.

See [page 302](#) for detailed instructions on setting this feature.



Select Micro PDF417 Length 1 Setting

To configure this feature, scan the ENTER/EXIT PROGRAMMING MODE bar code above, then the bar code at left followed by the digits from the Alphanumeric characters in [Appendix D, Keypad](#) representing your desired character(s). End by scanning the ENTER/EXIT bar code again.

Make a mistake? Scan the CANCEL bar code to abort and not save the entry string. You can then start again at the beginning.

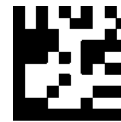

CANCEL

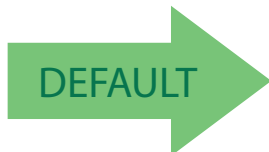

**0001 = Length 1 is 1 Character**



## Micro PDF417 Set Length 2

This feature specifies one of the bar code lengths for [Micro PDF417 Length Control on page 234](#). Length 2 is the maximum label length if in Variable Length Mode, or the second fixed length if in Fixed Length includes the bar code's data characters only. Characters can be set from 0001 to 0366 characters (pad with zeroes) in increments of 01. Any value greater than 0366 will be considered to be 0366.

See [page 303](#) for detailed instructions on setting this feature.



Select Micro PDF417 Length 2 Setting

To configure this feature, scan the ENTER/EXIT PROGRAMMING MODE bar code above, then the bar code at left followed by the digits from the Alphanumeric characters in [Appendix D, Keypad](#) representing your desired character(s). End by scanning the ENTER/EXIT bar code again.

Make a mistake? Scan the CANCEL bar code to abort and not save the entry string. You can then start again at the beginning.



CANCEL

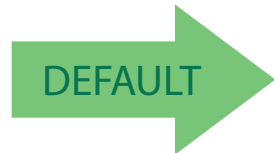

**Length 2 is 0366 Characters**



## QR Code

### QR Code Enable / Disable

Enables/disables the ability of the reader to decode QR Code labels.



### QR Code Length Control

This feature specifies either variable length decoding or fixed length decoding for this symbology.

**Variable Length:** For variable length decoding, a minimum and maximum length may be set.

**Fixed Length:** For fixed length decoding, two different lengths may be set.

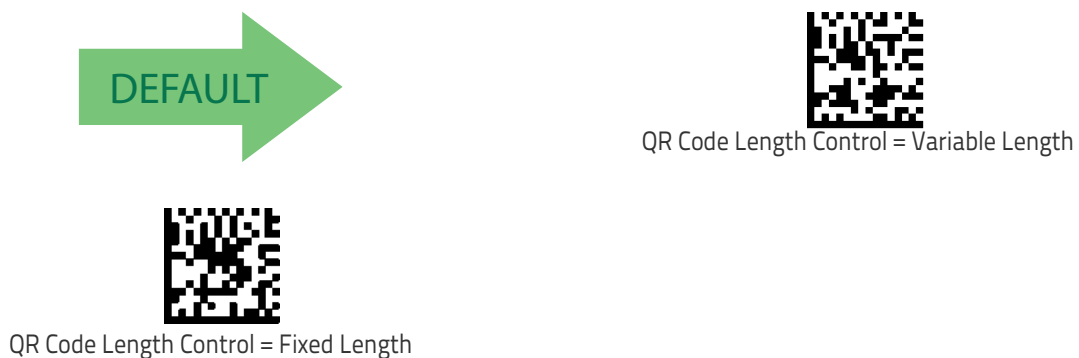



## QR Code Set Length 1

Specifies one of the bar code lengths for [QR Code Length Control on page 236](#). Length 1 is the minimum label length if in [Variable Length Mode](#), or the first fixed length if in [Fixed Length Mode](#). Characters can be set from 0001 to 7,089 characters in increments of 0001 (pad with zeroes).

See [page 302](#) for detailed instructions on setting this feature.



Select QR Code Length 1 Setting

To configure this feature, scan the ENTER/EXIT PROGRAMMING MODE bar code above, then the bar code at left followed by the digits from the Alphanumeric characters in [Appendix D, Keypad](#) representing your desired character(s). End by scanning the ENTER/EXIT bar code again.

Make a mistake? Scan the CANCEL bar code to abort and not save the entry string. You can then start again at the beginning.



CANCEL

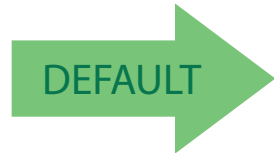

**0001 = Length 1 is 1 Character**



### QR Code Set Length 2

This feature specifies one of the bar code lengths for **QR Code Length Control** on page 236. Length 2 is the maximum label length if in Variable Length Mode, or the second fixed length if in Fixed Length Mode. Characters can be set from 0001 to 7,089 characters in increments of 0001 (pad with zeroes).

See page 303 for detailed instructions on setting this feature.



Select QR Code Length 2 Setting

To configure this feature, scan the ENTER/EXIT PROGRAMMING MODE bar code above, then the bar code at left followed by the digits from the Alphanumeric characters in **Appendix D, Keypad** representing your desired character(s). End by scanning the ENTER/EXIT bar code again.

Make a mistake? Scan the CANCEL bar code to abort and not save the entry string. You can then start again at the beginning.

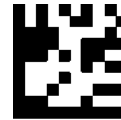

CANCEL

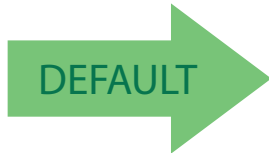

**Length 2 is 7,089 Characters**



## Micro QR Code

### Micro QR Code Enable/Disable

Enables/disables the ability of the reader to decode Micro QR Code labels.

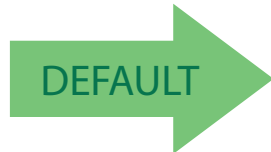

Micro QR Code = Disable



Micro QR Code = Enable

### Micro QR Code Length Control

This feature specifies either variable length decoding or fixed length decoding for this symbology.

**Variable Length:** For variable length decoding, a minimum and maximum length may be set.

**Fixed Length:** For fixed length decoding, two different lengths may be set.



Micro QR Code Length Control = Variable Length



Micro QR Code Length Control = Fixed Length



### Micro QR Code Set Length 1

Specifies one of the bar code lengths for [Micro QR Code Length Control on page 239](#). Length 1 is the minimum label length if in [Variable Length Mode](#), or the first fixed length if in [Fixed Length Mode](#). Characters can be set from 0001 to 0035 characters in increments of 0001 (pad with zeroes).

See [page 302](#) for detailed instructions on setting this feature.



Select Micro QR Code Length 1 Setting

To configure this feature, scan the ENTER/EXIT PROGRAMMING MODE bar code above, then the bar code at left followed by the digits from the [Alphanumeric characters in Appendix D, Keypad](#) representing your desired character(s). End by scanning the ENTER/EXIT bar code again.

Make a mistake? Scan the CANCEL bar code to abort and not save the entry string. You can then start again at the beginning.

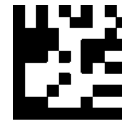

CANCEL

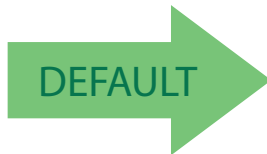

**0001 = Length 1 is 1 Character**



## Micro QR Code Set Length 2

This feature specifies one of the bar code lengths for [Micro QR Code Length Control on page 239](#). Length 2 is the maximum label length if in Variable Length Mode, or the second fixed length if in Fixed Length Mode. Characters can be set from 0001 to 0035 characters in increments of 0001 (pad with zeroes).

See [page 303](#) for detailed instructions on setting this feature.



Select QR Code Length 2 Setting

To configure this feature, scan the ENTER/EXIT PROGRAMMING MODE bar code above, then the bar code at left followed by the digits from the Alphanumeric characters in [Appendix D, Keypad](#) representing your desired character(s). End by scanning the ENTER/EXIT bar code again.

Make a mistake? Scan the CANCEL bar code to abort and not save the entry string. You can then start again at the beginning.



CANCEL

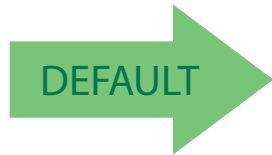

**Length 2 is 0035 Characters**



## UCC Composite

### UCC Optional Composite Timer

Specifies the amount of time the system will wait for the stacked part of a UCC Composite label before transmitting the linear label without an add-on.

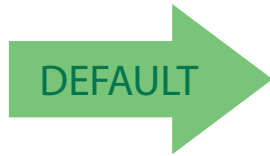

UCC Optional Composite Timer = Timer Disabled



UCC Optional Composite Timer = 100msec



UCC Optional Composite Timer = 200msec



UCC Optional Composite Timer = 300msec



UCC Optional Composite Timer = 400msec



UCC Optional Composite Timer = 500msec



## Postal Code Selection

Enables/disables the ability of the scanner to decode labels of a specific postal symbology.

- Disable All Postal Codes
- Postnet
- Planet
- Royal Mail
- Kix
- Australia Post
- Japan Post
- IMB
- Sweden Post
- Portugal Post

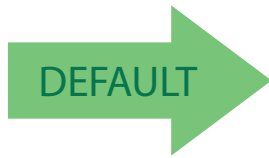

Postal Code Selection = Disable All Postal Codes



Postal Code Selection = Enable Postnet



Postal Code Selection = Enable Planet



Postal Code Selection = Enable Royal Mail



Postal Code Selection = Enable Kix



Postal Code Selection = Enable Australia Post



### Postal Code Selection (continued)



Postal Code Selection = Enable Japan Post

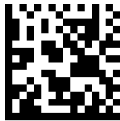

Postal Code Selection = Enable IMB



Postal Code Selection = Enable Sweden Post

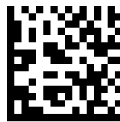

Postal Code Selection = Enable Portugal Post

### Postnet BB Control

Controls the ability of the scanner to decode B and B' fields of Postnet labels.

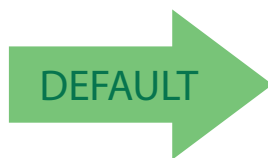

Postnet BB Control = Disable











Postnet BB Control = Enable

## Battery Profiles

Gryphon GBT/GM45 provides the user the ability to select different usage profiles to better configure the reader with respect to specific needs. By default, the Maximum Performances profile is selected and provides high snappiness and max reading capability. The user can then decide to exploit specific features when others are considered less important, for instance: fast battery recharge instead of battery health, maximum reading performances instead of battery autonomy, etc.

Here below different Battery Profiles are described with associated benefits and limitations:

	<p><b>Maximum Performances (default)</b></p> <ul style="list-style-type: none"> <li>• Scanner autonomy for heavy workload (80.000 scans for more than 22h<sup>a</sup>)</li> <li>• Motionix™ enabled</li> <li>• Max radio communication performances</li> </ul>	
	<p><b>Maximum Battery Health</b></p> <ul style="list-style-type: none"> <li>• Battery capacity is preserved<sup>b</sup></li> <li>• Reduced max charging current</li> <li>• Reduced battery capacity by ~20%</li> <li>• Increased recharge time: +20% on average (it depends on the specific scanner configuration)</li> </ul>	
	<p><b>Maximum Autonomy</b></p> <ul style="list-style-type: none"> <li>• Max scanner autonomy (approx. 83h<sup>c</sup>)</li> <li>• Motionix™ disabled</li> <li>• Vibro motor disabled</li> <li>• Reduced Radio Star™ responsiveness<sup>d</sup></li> <li>• Increased Sniff-time period<sup>e</sup> (Bluetooth™)</li> </ul>	
	<p><b>Fast Charge</b></p> <ul style="list-style-type: none"> <li>• Reduced recharge time (approx. 20%)</li> <li>• Motionix™ disabled</li> <li>• Vibro motor disabled</li> <li>• Scan-While-Charging disabled (Trigger Single)</li> </ul>	

- a. 1 read per second, continuous reading with no idle status
- b. after 300 full charge cycles at room temperature 25° C (77° F), more than 80% of the original capacity is still available
- c. 10 reads in 10 seconds and 50 seconds idle
- d. host commands from cradle will not be received, asynchronous data from cradle will not be received, out-of-range signaling will not work, configuration exchange will not be executed automatically (only after trigger pressure)
- e. barcode reading shall be less snappy, execution of commands received from base shall be delayed until gun is ready



# Motion Features

<b>MOTION AIMING CONTROL</b> on page 231
<b>MOTION SENSITIVITY</b> on page 232
<b>MOTIONLESS TIMEOUT</b> on page 233

Use this chapter to configure motion settings for the handheld.  
Reference [Appendix B](#), for a listing of standard factory settings.

## Motion Aiming Control

Configures the ability of the scanner to Enable/Disable the Aiming system when motion is detected.



## Motion Sensitivity

Defines discrete set of levels for scanner motion sensitivity when in handheld use.







## Motionless Timeout

Specifies the waiting time in 100 millisecond ticks to assume that the reader is in a motionless condition. The selectable range is 500 msec to 25.5 Seconds. When no motion event is detected for a period of time longer than this timeout, the software assumes the reader is in a motionless condition. This normally results in returning the scanner to Stand Mode. This option relates to such features as Aimer On and Stand Mode Object Sense scanning with respect to motion.



Select Motionless Timeout Setting

To configure this feature, scan the ENTER/EXIT PROGRAMMING MODE bar code above, then the bar code at left followed by three digits from the Alphanumeric characters in [Appendix D, Keypad](#) representing your desired character(s). End by scanning the ENTER/EXIT bar code again.

Make a mistake? Scan the CANCEL bar code to abort and not save the entry string. You can then start again at the beginning.

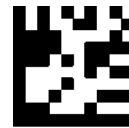

CANCEL

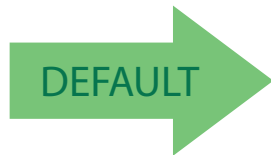

**020 = Motionless Timeout = 2 seconds**

# NOTES

# Wireless Features

This section provides options and programming related to the reader's wireless communication features. Reference [Appendix B](#), for a listing of standard factory settings.

<b>WIRELESS BEEPER FEATURES</b> starting on page 250 <ul style="list-style-type: none"><li>•Good Transmission Beep on page 250</li><li>•Beep Frequency on page 250</li><li>•Beep Duration on page 251</li><li>•Beep Volume on page 252</li><li>•Disconnect Beep on page 252</li><li>•Docking Beep on page 253</li><li>•Leash Alarm on page 253</li></ul>
<b>CONFIGURATION UPDATES</b> starting on page 237 <ul style="list-style-type: none"><li>•Automatic Configuration Update on page 237</li><li>•Copy Configuration to Scanner on page 255</li><li>•Copy Configuration to Base Station on page 256</li></ul>
<b>BATCH FEATURES</b> starting on page 256 <ul style="list-style-type: none"><li>•Batch Mode on page 256</li><li>•Send Batch on page 239</li><li>•Erase Batch Memory on page 239</li><li>•RF Batch Mode Transmit Delay on page 258</li></ul>
<b>DIRECT RADIO AUTOLINK</b> starting on page 240
<b>BLUETOOTH-ONLY FEATURES</b> starting on page 241 <ul style="list-style-type: none"><li>•Source Radio Address Transmission on page 260</li><li>•Source Radio Address Delimiter Character on page 261</li><li>•BT Security Mode on page 262</li><li>•BT PIN Code on page 244</li><li>•Select PIN Code Length on page 244</li><li>•Set PIN Code on page 244</li><li>•Bluetooth HID Variable PIN Code on page 264</li><li>•Bluetooth HID Alt Mode on page 265</li><li>•Bluetooth HID Send Unknown ASCII Char on page 265</li><li>•HID Country Mode on page 266</li><li>•Powerdown Timeout on page 269</li></ul>
<b>FEATURES FOR STAR MODELS ONLY</b> starting on page 270 <ul style="list-style-type: none"><li>•STAR Radio Protocol Timeout on page 270</li><li>•STAR Radio Transmit Mode on page 271</li></ul>



## Wireless Beeper Features

Several options are available to configure beeper behavior for RF operation.

### Good Transmission Beep

Enables/disables the Good Transmission Beep indication. When enabled, a beep occurs when a Label is correctly transmitted to the base.



Good Transmission Beep = Disable



Good Transmission Beep = Enable



### Beep Frequency

Adjusts radio-specific beep indications to sound at a low, medium or high frequency, selectable from the list below (controls the beeper's pitch/tone).

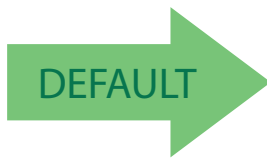

Beep Frequency = Low



Beep Frequency = Medium



Beep Frequency = High

## Beep Duration

This feature controls the duration of radio-specific beep indications.

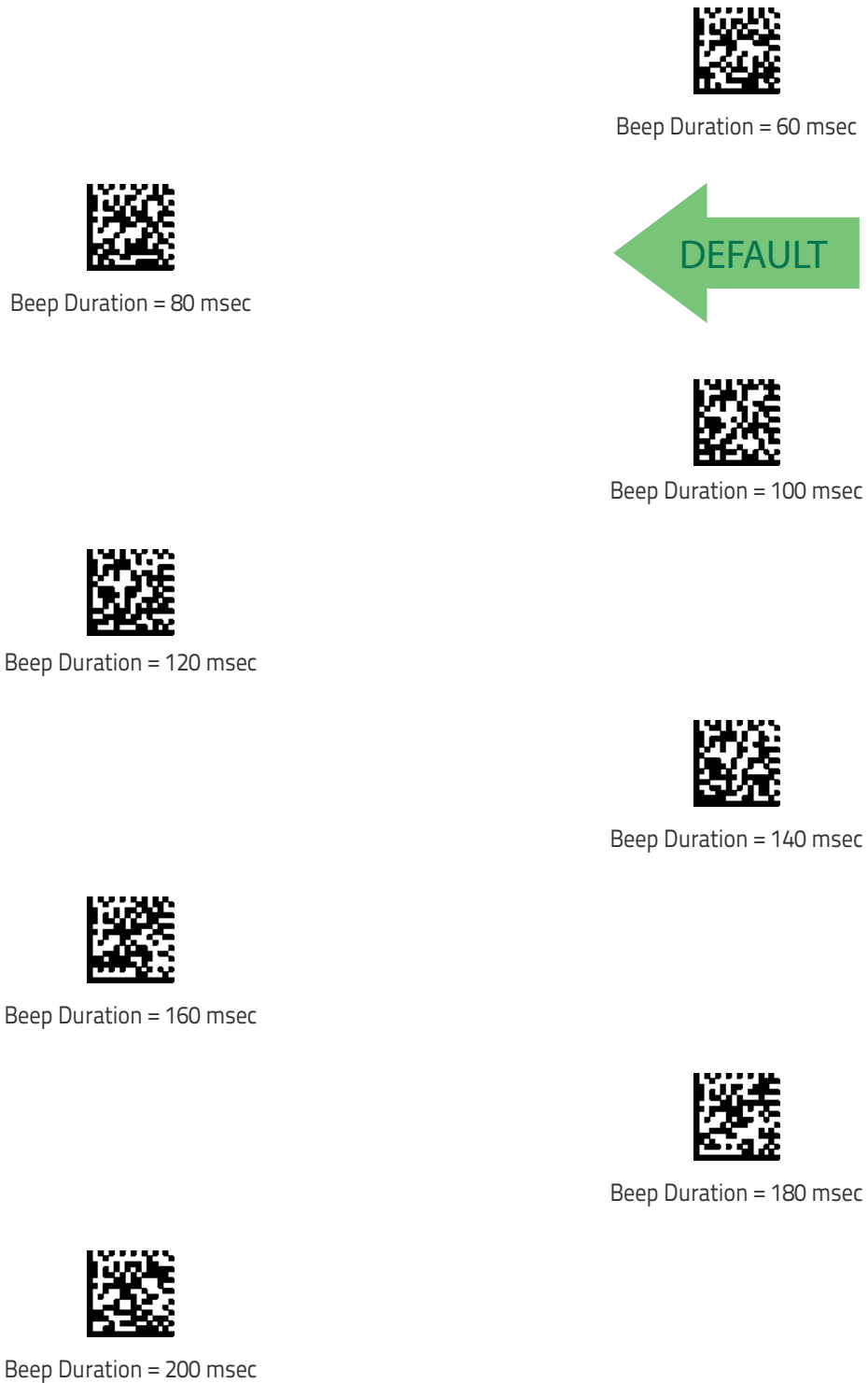



### Beep Volume

Selects the beeper volume (loudness) of radio-specific beep indications. There are three selectable volume levels.



Beep Volume = Low



Beep Volume = Medium



Beep Volume = High



### Disconnect Beep

Enables/disables the beep indication that a handheld has become connected or disconnected from a Base Station.



The defaults are different for the STAR and BT models.



Disconnect Beep = Disable



Disconnect Beep = Enable



## Docking Beep

Enables/disables a beep indication when the handheld is placed in the Base Station.



Docking Beep = Enable



Docking Beep = Disable



## Leash Alarm

This setting specifies the number of seconds to sound the Leash Mode beeps (three per second) when the handheld goes out of range. This is especially useful in instances where the reader might inadvertently have been placed in a bag or cart.

For this mode to be effective, the reader must be linked to the Base Station. If the reader is asleep or disconnected from the Base Station, there is no way for it to know where it is relative to the Base Station because communication is not active between the devices.

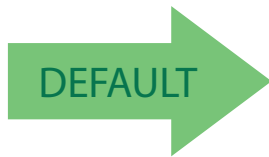

Leash Alarm = Disabled



Leash Alarm = 1 Second



Leash Alarm = 2 Seconds



## Leash Alarm (continued)



Leash Alarm = 3 Seconds



Leash Alarm = 4 Seconds



Leash Alarm = 5 Seconds



Leash Alarm = 10 Seconds



Leash Alarm = 25 Seconds



Leash Alarm = 30 Seconds



## Configuration Updates

See [page 259](#) in “References” for detailed information and examples of these features.

### Automatic Configuration Update

When this feature is enabled, a reader and its linked Base Station can automatically ensure they stay in sync with regard to application hardware and/or configuration. See [page 259](#) for more information on this feature.



Automatic Configuration Update = Disable



Automatic Configuration Update = Enable



### Copy Configuration to Scanner

Scan the following label to copy the current Base Station configuration to the scanner. Use this method when the Auto Configuration Update feature is disabled and you want a one-time configuration update to be performed on the scanner.



**NOTE**

**Do not scan an ENTER/EXIT PROGRAMMING MODE label in conjunction with this bar code.**

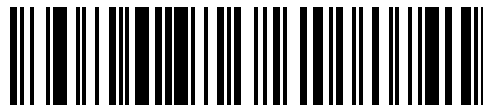

Copy Configuration to Scanner



### Copy Configuration to Base Station

Scan the following label to copy the current scanner configuration to the Base Station. Use this method when the Auto Configuration Update feature is disabled and you want a one-time configuration update to be performed on the Base Station.

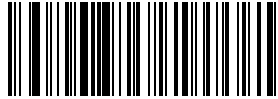

Copy Configuration to Base Station



NOTE

Do not scan an ENTER/EXIT PROGRAMMING MODE label with this bar code.

## Batch Features

### Batch Mode

This option specifies whether to store labels in the handheld while disconnected from the base. Options are as follows:

- Disabled — The handheld will not store/batch labels.
- Automatic — The handheld will store labels to RAM when the handheld goes out of range and is disconnected from the remote device.
- Manual — The handheld will always store labels to Flash memory. The user must manually send the stored labels to the remote device using a special "batch send" label.

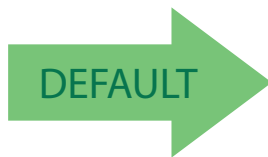

Batch Mode = Disabled



Batch Mode = Automatic



Batch Mode = Manual



## Send Batch

When the scanner is configured in Manual Batch Mode, use the following bar code to initiate sending of labels stored in batch memory.



**NOTE**

**Do not scan an ENTER/EXIT PROGRAMMING MODE label in conjunction with this bar code.**

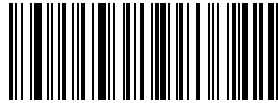

Send Batch

## Erase Batch Memory

When the scanner is configured in Manual Batch Mode, use the following bar code to erase any labels stored in batch memory.



**NOTE**

**Do not scan an ENTER/EXIT PROGRAMMING MODE label in conjunction with this bar code.**

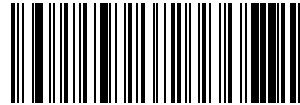

Erase Batch Memory



### RF Batch Mode Transmit Delay

Specifies the delay in 10 msec increments between transmitting labels stored in batch memory.

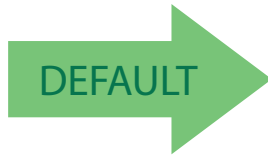

RF Batch Mode Transmit Delay = No Delay



RF Batch Mode Transmit Delay = 50 mS



RF Batch Mode Transmit Delay = 100 mS



RF Batch Mode Transmit Delay = 0.5 seconds



RF Batch Mode Transmit Delay = 1 second



RF Batch Mode Transmit Delay = 2.5 seconds

## Direct Radio Autolink

This feature enables/disables the ability to link a wireless handheld to a base station without scanning the Unlink label first.

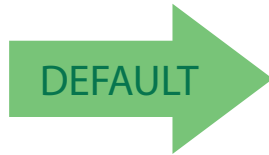

Direct Radio Link = Unlink Label Required



Direct Radio Link = Automatic Unlinking



## Bluetooth-Only Features

The features in this section are valid only for Gryphon Bluetooth models. Also reference the Setup section for instructions on "Linking a BT Reader to a PC," starting on page 18.

### RF Address Stamping

These features allow configuration of source radio data inclusion.

#### Source Radio Address Transmission

Enables/disables the ability of source radio address information to be transmitted to the host and, if so, at what position with respect to the label data. See page 259 in "References" for detailed information and examples for setting this feature.



**NOTE**

When included as a prefix, the source-radio ID is displayed after all label formatting has been applied. The 6 byte hex address is sent as 12 ascii characters, i.e., an address of 00 06 66 00 1A ED will be sent as (shown in hex): 30 30 30 36 36 36 30 30 31 41 45 44

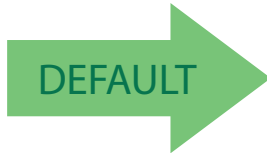

Source Radio Address Transmission = Do Not Include



Source Radio Address Transmission = Prefix



## Source Radio Address Delimiter Character

This option specifies the delimiter character to be placed between the label data and radio address when address stamping is enabled.



### NOTE

This feature only applies if "Source Radio Address Transmission" on page 260 is enabled.



Set Source Radio Address Delimiter Character

To configure this feature, scan the ENTER/EXIT PROGRAMMING MODE bar code above, then the bar code at left followed by the digits from the Alphanumeric characters in [Appendix D, Keypad](#) representing your desired character(s). End by scanning the ENTER/EXIT bar code again.

Make a mistake? Scan the CANCEL bar code to abort and not save the entry string. You can then start again at the beginning.



CANCEL

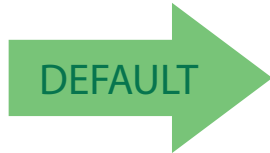

**00 = No Delimiter Character**



## BT Security Features

On the BT system, it is possible to set a (configurable) PIN code to authenticate/connect BT devices, and encrypt the data.

The BT PIN code can be enabled and configured by reading the bar codes in the following sections.



**NOTE**

**If you are using a BT scanner directly connected to a host through a BT dongle, verify that the scanner and the BT driver used by the dongle share the same PIN code and the same security level. Otherwise the connection cannot be established.**

Follow these steps to set the PIN code for a scanner:

1. Enable BT Security Mode by scanning the “Enable” bar code below.
2. Select a PIN code length of either 4 or 16 characters by scanning the appropriate bar code in "Select PIN Code Length" on page 244.
3. Scan the relevant bar code from "Set PIN Code" on page 244, then scan the desired alphanumeric characters from the keypad in Appendix D, Keypad to set the PIN code.

See page 301 in “References” for more detailed information and examples for this feature.

### BT Security Mode

This feature enables/disables authentication and encryption of the BT link. Use the feature "BT PIN Code" on page 244 to specify the length and digits in the PIN code used to authenticate the BT Link.



**NOTE**

**Changing the security mode setting will unlink the devices. If the Automatic Configuration Update is set to the default "Enabled" setting, the devices must only be relinked. If the Automatic Configuration Update is set to "Disabled," the Security Mode setting must also be updated in the Base Station using Aladdin. After the Base Station has been updated, the devices must be relinked.**



BT Security Mode = Disable



BT Security Mode = Enable



### BT PIN Code

After enabling Security Mode (see "BT Security Mode" on page 262), specify whether you want to set a 4-digit or a 16-digit PIN Code. See page 301 for detailed information and examples for setting this feature.

### Select PIN Code Length



### Set PIN Code

Determine the desired characters for the PIN code, then convert to hexadecimal using the [ASCII Chart](#) on the inside back cover of this manual. See page 301 for detailed information and examples for setting this feature.



To configure this feature, scan the ENTER/EXIT PROGRAMMING MODE bar code above, then the bar code at left followed by the digits from the Alphanumeric characters in [Appendix D, Keypad](#) representing your desired character(s). End by scanning the ENTER/EXIT bar code again.



Make a mistake? Scan the CANCEL bar code to abort and not save the entry string. You can then start again at the beginning.

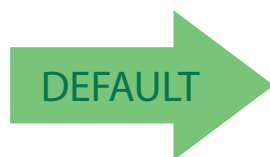

**31323334 = Default PIN Code is 1234**



## Other BT Features

### Bluetooth HID Variable PIN Code

Specifies the selection available for Static or Variable Pin Code, when Bluetooth HID profile is configured.

Some Bluetooth drivers on the Host (such as WIDCOMM and BlueSoleil 8) require a Variable PIN Code. When attempting connection, the application presents a window that includes a PIN Code which is to be input using the Gryphon GBT4400. Scan the bar code "Variable PIN Code" below, then use the host computer's Bluetooth manager to "Discover new devices" and select "Datalogic Scanner." Use a text editor to see incoming data on the port designated by the computer's Bluetooth manager.



**If you receive an error message, it may be necessary to disable security on the device.**

#### NOTE

When you hear the beep and see the Green LED blinking indicating the reader is waiting for an alphanumeric entry, enter the required variable PIN Code by scanning the corresponding bar codes in [Appendix D, Keypad](#) for alphanumeric entry. Finish by scanning the Exit HID Variable PIN Code label.



Set Static Pin Code



Set Variable Pin code



CANCEL

Make a mistake? Scan the CANCEL bar code to abort and not save the entry string. You can then start again at the beginning.

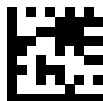

Exit HID Variable PIN Code



### Bluetooth HID Alt Mode

Enable/Disable the ability to correctly transmit a label to the host regardless of the Bluetooth HID Country Mode selected, when Bluetooth HID Profile is configured.

Read the configuration command label below for the HID Alt Mode feature.



HID Alt Mode = OFF



HID Alt Mode = ON

### Bluetooth HID Send Unknown ASCII Char

Unknown characters are characters the host does not recognize. When Disable HID Send ASCII Unknown character is selected, all barcode data is sent except for unknown characters, and an error beep will sound. When HID Send Unknown ASCII character is enabled, an unknown character will be sent as a SPACE.

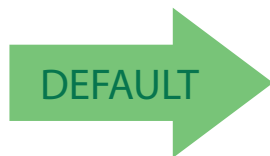

HID Send Unknown ASCII character = Disable



HID Send Unknown ASCII character = Enable



## HID Country Mode

When the Reader is connected with a Bluetooth Adapter in HID mode, you may want to set the country for which your PC is localized. In order to do that, read one of the configuration command labels below.



Country Mode = U.S.



Country Mode = Belgium



Country Mode = Britain



Country Mode = Croatia



Country Mode = Czech Republic



Country Mode = Denmark



Country Mode = France

## HID Country Mode (Continued)



Country Mode = French Canadian



Country Mode = Germany



Country Mode = Hungary



Country Mode = Italy



Country Mode = Japanese 106-key



Country Mode = Lithuanian



Country Mode = Norway



Country Mode = Poland



## HID Country Mode (Continued)



Country Mode = Portugal



Country Mode = Romania



Country Mode = Spain



Country Mode = Sweden



Country Mode = Slovakia



Country Mode = Switzerland

## Power Off

See **POWER OFF** on page 29 for information about this BT feature.

### Powerdown Timeout

The Powerdown Timeout feature sets the time for automatically switching the unit off when the imager has been idle.



Powerdown Timeout = Disable



Powerdown Timeout = 10 minutes



Powerdown Timeout = 20 minutes



Powerdown Timeout = 30 minutes



Powerdown Timeout = 60 Minutes (1 Hour)



Powerdown Timeout = 120 Minutes (2 Hours)



## Features for Star Models only



The features in this section are valid only for the Gryphon I GM440X Star model:

- STAR Radio Protocol Timeout on page 270
- STAR Radio Transmit Mode on page 271

### STAR Radio Protocol Timeout

This parameter sets the valid wait time before transmission between the hand-held reader and Base Station is considered failed.

When setting this parameter, take into consideration the radio traffic (number of readers in the same area). The selectable range for this feature is from 02 to 25 seconds. See page 260 in “References” for detailed information and examples for setting this feature.

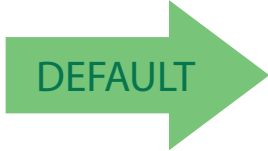
 <p>Set Radio Protocol Timeout</p>	
<p>Make a mistake? Scan the CANCEL barcode to abort and not save the entry string. You can then start again at the beginning.</p>	 <p>CANCEL</p>
 <p><b>02 = 2 Seconds Radio Protocol Timeout</b></p>	







## STAR Radio Transmit Mode

Specifies the transmission protocol for Star communications.

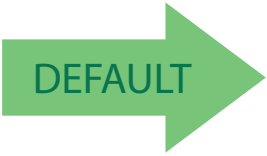
Options are:

- ACK from cradle to scanner — signals a good transmission as soon as the Base Station receives a label
- ACK when sent to host — scanner signals a good transmission as soon as the Base Station has sent the label to the host
- ACK from host — scanner signals a good transmission as soon as the Base Station has sent the label to the host and host has replied with an acknowledge message.

	 ACK from cradle
 ACK when sent to host	
	 ACK from host



**NOTE**

ACK from host works only for RS-232 or USB-COM interfaces with ACK/NACK disabled. If ACK from host is configured with any other interface conditions, it works like ACK when sent to host.

See "Message Formatting" on page 305 for details.



**NOTE**

The Base Station can receive a host message only if Host Commands Obey/Ignore (page 35) is set to Ignore.

# NOTES



## Chapter 4 References

This section contains explanations and examples of selected bar code features. See "Configuration Using Bar Codes" starting on page 37 for the actual bar code labels used to configure the scanner.

<b>RS-232 PARAMETERS</b> on page 274
<ul style="list-style-type: none"><li>▪ RS-232 Only on page 274</li><li>▪ RS-232/USB COM Parameters on page 275</li></ul>
<b>KEYBOARD INTERFACE</b> on page 282
<ul style="list-style-type: none"><li>▪ Wedge Quiet Interval on page 282</li><li>▪ Intercharacter Delay on page 283</li><li>▪ Intercode Delay on page 284</li></ul>
<b>DATA FORMAT</b> on page 285
<ul style="list-style-type: none"><li>▪ Data Editing on page 285</li><li>▪ Global Prefix/Suffix on page 286</li><li>▪ Global AIM ID on page 287</li><li>▪ Label ID on page 288</li><li>▪ Character Conversion on page 292</li></ul>
<b>SCANNING FEATURES</b> on page 253
<ul style="list-style-type: none"><li>▪ Scanning Features on page 253</li></ul>
<b>SCANNING FEATURES</b> on page 253
<ul style="list-style-type: none"><li>▪ Scan Mode on page 294</li><li>▪ Scanning Active Time on page 295</li><li>▪ Flash On Time on page 297</li><li>▪ Flash Off Time on page 298</li></ul>
<b>SYMBOLOGIES</b> on page 302
<ul style="list-style-type: none"><li>▪ Set Length on page 302</li><li>▪ Set Length on page 302</li></ul>

## RS-232 Parameters

### RS-232 Only

#### Baud Rate

Baud rate is the number of bits of data transmitted per second. Set the scanner's baud rate to match the baud rate setting of the host device. With an improper baud rate setting, data may not reach the host correctly.

#### Data Bits

This parameter allows the reader to interface with devices requiring a 7-bit or 8-bit ASCII protocol for sending and receiving data.

#### Stop Bits

The stop bit(s) at the end of each transmitted character marks the end of transmission of one character and prepares the receiving device for the next character in the serial data stream. The number of stop bits selected (one or two) depends on the number the receiving terminal is programmed to accommodate. Set the number of stop bits to match host device requirements.

#### Parity

This feature specifies parity required for sending and receiving data. A parity check bit is the most significant bit of each ASCII coded character. Select the parity type according to host device requirements.

- Select None when no parity bit is required.
- Select Odd parity and the parity bit value is set to 0 or 1, based on data, to ensure that an odd number of 1 bits are contained in the coded character.
- Select Even parity and the parity bit value is set to 0 or 1, based on data, to ensure that an even number of 1 bits are contained in the coded character.

#### Handshaking Control

The data interface consists of an RS-232 port designed to operate either with or without the hardware handshaking lines, Request to Send (RTS), and Clear to Send (CTS). Handshaking Control includes the following options:

- RTS — RTS is asserted during transmissions. CTS is ignored.
- RTS/CTS — RTS is asserted during transmissions. CTS gates transmissions.
- RTS/XON/XOFF — RTS is asserted during transmissions. CTS is ignored. XON and XOFF gate transmissions.
- RTS On/CTS — RTS is always asserted. CTS gates transmissions.
- RTS/CTS Scan Control — RTS is asserted during transmissions. CTS gates transmissions and controls enable and disable state of scanner.

## RS-232/USB COM Parameters

### Intercharacter Delay

This parameter specifies the intercharacter delay between the end of one character and the beginning of the next. The delay can be set within a range of zero (0) to 990 milliseconds in 10ms increments. A setting of zero specifies no delay.

To set the delay:

1. Determine the desired setting in milliseconds.
2. Divide the desired setting by 10 (setting is in 10ms increments). Pad the result with leading zeroes to yield two digits. For example: 0 = 00, 5 = 05, 20 = 20, etc.
3. Scan the ENTER/EXIT PROGRAMMING MODE bar code to enter Programming Mode.
4. Go to [page 46](#) and scan the bar code: SELECT INTERCHARACTER DELAY SETTING.
5. Scan the appropriate two digits from the keypad in [Appendix D, Keypad](#), that represent the duration which was determined in the steps above. You will hear a two-beep indication after the last character.



If you make a mistake before the last character, scan the CANCEL bar code to abort and not save the entry string. You can then start again at the beginning.

#### NOTE

6. Scan the ENTER/EXIT PROGRAMMING MODE bar code to exit.

This completes the procedure. See the following table for examples of how to set this feature.

**Table 5. Intercharacter Delay Setting Examples**

STEP	ACTION	EXAMPLES			
1	Desired Setting	50ms	150ms	600ms	850ms
2	Divide by 10 (pad with leading zeroes to yield two-digits)	05	15	60	85
3	Scan ENTER/EXIT PROGRAMMING MODE				
4	Scan SELECT INTERCHARACTER DELAY SETTING				
5	Scan Two Characters From Appendix D, Keypad	'0' and '5'	'1' and '5'	'6' and '0'	'8' and '5'
6	Scan ENTER/EXIT PROGRAMMING MODE				

## ACK NAK Options

This enables/disables the ability of the scanner to support the RS-232 ACK/NAK protocol. When configured, the scanner and/or host sends an “ACK” when it receives data properly, and sends “NAK” when the data is in error.

Options are:

- Disable
- Enable for label transmission — The scanner expects an ACK/NAK response from the host when a label is sent
- Enable for host-command acknowledge — The scanner will respond with ACK/NAK when the host sends a command
- Enable for label transmission and host-command acknowledge

## ACK Character

This setting specifies an ASCII character or hex value to be used as the ACK character. ASCII characters or any hex value from 0 to 0xFF can be selected.



### NOTE

Setting to previously defined characters such as XON, XOFF, or host commands conflicts with normal operation of these characters. 8-bit data is not recognized when the option Data Bits on page 42 has been set as 7 Data Bits.

1. Determine the desired character or value.
2. Use the [ASCII Chart on page 343](#) on the inside back cover of this manual to find the hex equivalent for the desired character/value.
3. Go to [page 49](#) and scan ENTER/EXIT PROGRAMMING MODE to enter Programming Mode.
4. Scan the bar code: SELECT ACK CHARACTER SETTING.
5. Scan the appropriate two alphanumeric characters from the keypad in [Appendix D, Keypad](#), that represent the desired character/value determined above. The second character will cause a two-beep indication.
6. Scan the ENTER/EXIT PROGRAMMING MODE bar code to exit.

See the table below for examples of how to set this feature.

**Table 6. ACK Character Setting Examples**

STEP	ACTION	EXAMPLES			
1	Desired Character/Value	ACK	\$	@	>
2	Hex equivalent from ASCII Chart on page 343	0x06	0x24	0x40	0x3E
3	Scan ENTER/EXIT PROGRAMMING MODE				
4	Scan SELECT ACK CHARACTER SETTING				
5	Scan Two Characters from Appendix D, Keypad	'0' and '6'	'2' and '4'	'4' and '0'	'3' AND 'E'
6	Scan ENTER/EXIT PROGRAMMING MODE				

## NAK Character

This setting specifies an ASCII character or hex value to be used as the NAK character. ASCII characters or any hex value from 0 to 0xFF can be selected.



### NOTE

Setting to previously defined characters such as XON, XOFF, or host commands conflicts with normal operation of these characters. 8-bit data is not recognized when the option Data Bits on page 42 has been set as 7 Data Bits.

To set this feature:

1. Determine the desired character or value.
2. Use the [ASCII Chart on page 343](#) on the inside back cover of this manual to find the hex equivalent for the desired character/value.
3. Scan the ENTER/EXIT PROGRAMMING MODE bar code to enter Programming Mode.
4. Scan the bar code: SELECT NAK CHARACTER SETTING.
5. Scan the appropriate two alpha-numeric characters from the keypad in [Appendix D, Keypad](#), that represent the desired character/value determined above. The second character will cause a two-beep indication.
6. Scan the ENTER/EXIT PROGRAMMING MODE bar code to exit Programming Mode.

This completes the procedure. See the table below for examples of how to set this feature.

**Table 7. NAK Character Setting Examples**

STEP	ACTION	EXAMPLES			
1	Desired Character/Value	NAK	\$	@	>
2	Hex equivalent	0x15	0x24	0x40	0x3E
3	Scan ENTER/EXIT PROGRAMMING MODE				
4	Scan SELECT NAK CHARACTER SETTING				
5	Scan Two Characters From Appendix D, Keypad	'1' and '5'	'2' and '4'	'4' and '0'	'3' AND 'E'
6	Scan ENTER/EXIT PROGRAMMING MODE				

## ACK NAK Timeout Value

This option specifies the amount of time the scanner waits for an ACK character from the host following label transmission. The selectable timeout range is 200 milliseconds to 15,000ms (15 seconds) in 200ms increments. A selection of 0 disables the timeout.

To set this value:

1. Determine the desired setting in milliseconds.
2. Divide the desired setting by 200 (setting is in 200ms increments). Pad the result with leading zeroes to yield two digits. For example: 0 = 00, 5 = 05, 20 = 20, etc.
3. Go to [page 50](#) and scan the ENTER/EXIT PROGRAMMING MODE bar code to enter Programming Mode.
4. Scan the bar code: SELECT ACK NAK TIMEOUT VALUE SETTING.
5. Scan the appropriate two digits from the keypad in [Appendix D, Keypad](#), that represent the duration which was determined in the steps above. You will hear a two-beep indication after the last character.



### NOTE

If you make a mistake before the last character, scan the CANCEL bar code to abort and not save the entry string. You can then start again at the beginning.

6. Scan the ENTER/EXIT PROGRAMMING MODE bar code to exit Programming Mode.

This completes the procedure. See the table below for examples of how to set this feature.

**Table 8. ACK NAK Timeout Value Setting Examples**

STEP	ACTION	EXAMPLES			
1	Desired Setting	200ms	1,000ms (1 sec.)	5200ms (5.2 sec.)	15,000ms (15 sec.)
2	Divide by 200	01	05	26	75
3	Scan ENTER/EXIT PROGRAMMING MODE				
4	Scan SELECT ACK NAK TIMEOUT VALUE SETTING				
5	Scan Two Characters From Appendix D, Keypad	'0' and '1'	'0' and '5'	'2' and '6'	'7' and '5'
6	Scan ENTER/EXIT PROGRAMMING MODE				



## ACK NAK Retry Count

This feature specifies the number of times the scanner retries a label transmission due to a retry condition. The selectable range is from 1 to 254 retries. A selection of 0 disables the count, and a selection of 255 specifies unlimited retries.

To set this feature:

1. Determine the desired setting.
2. Pad the number with leading zeroes to yield three digits. For example: 0 = 000, 5 = 005, 20 = 020, etc.
3. Go to [page 51](#) and scan the ENTER/EXIT PROGRAMMING MODE bar code to enter Programming Mode.
4. Scan the bar code: SELECT ACK NAK RETRY COUNT SETTING.
5. Scan the appropriate three digits from the keypad in [Appendix D, Keypad](#), that represent the number which was determined in the steps above. You will hear a two-beep indication after the last character.



### NOTE

If you make a mistake before the last character, scan the CANCEL bar code to abort and not save the entry string. You can then start again at the beginning.

6. Scan the ENTER/EXIT PROGRAMMING MODE bar code to exit Programming Mode.

This completes the procedure. See the table below for examples of how to set this feature.

**Table 9. ACK NAK Retry Count Setting Examples**

STEP	ACTION	EXAMPLES			
1	<b>Desired Setting</b>	Disable Retry Count	3 Retries	54 Retries	Unlimited Retries
2	<b>Pad with leading zero(es)</b>	000	003	054	255
3	<b>Scan ENTER/EXIT PROGRAMMING MODE</b>				
4	<b>Scan SELECT ACK NAK RETRY COUNT SETTING</b>				
5	<b>Scan Three Characters From Appendix D, Keypad</b>	'0', '0' and '0'	'0', '0' and '3'	'0', '5' and '4'	'2', '5' and '5'
6	<b>Scan ENTER/EXIT PROGRAMMING MODE</b>				

## Disable Character

Specifies the value of the RS-232 host command used to disable the scanner. ASCII characters or any hex value from 0 to 0xFF can be selected.



### NOTE

Setting to previously defined characters such as XON, XOFF, or host commands conflicts with normal operation of these characters. 8-bit data is not recognized when the option Data Bits on page 42 has been set as 7 Data Bits.

To set the value:

1. Determine the desired character or value. A setting of 0xFF indicates the Disable Character is not used (not available).
2. Use the [ASCII Chart on page 343](#) on the inside back cover of this manual to find the hex equivalent for the desired character/value.
3. Go to [page 53](#) and scan the ENTER/EXIT PROGRAMMING MODE bar code to enter Programming Mode.
4. Scan the bar code: SELECT DISABLE CHARACTER SETTING on [page 53](#).
5. Scan the appropriate two alphanumeric characters from the keypad in [Appendix D, Keypad](#), that represent the desired character/value determined above. The second character will cause a two-beep indication.
6. Scan the ENTER/EXIT PROGRAMMING MODE bar code to exit Programming Mode.

This completes the procedure. See the table below for examples of how to set this feature.

**Table 10. Disable Character Setting Examples**

STEP	ACTION	EXAMPLES			
1	Desired character/value	'd'	'y'	'D'	Disable Command Not Used
2	Hex equivalent from ASCII Chart on page 343	0x64	0x7D	0x44	0xFF
3	Scan ENTER/EXIT PROGRAMMING MODE				
4	Scan SELECT DISABLE CHARACTER VALUE SETTING				
5	Scan Two Characters From Appendix D, Keypad	'6' and '4'	'7' and 'D'	'4' and '4'	'F' and 'F'
6	Scan ENTER/EXIT PROGRAMMING MODE				

## Enable Character

Specifies the value of the RS-232 host command used to enable the scanner. ASCII characters or any hex value from 0 to 0xFF can be selected.



### NOTE

Setting to previously defined characters such as XON, XOFF, or host commands conflicts with normal operation of these characters. 8-bit data is not recognized when the option Data Bits on page 42 has been set as 7 Data Bits.

To set this feature:

Determine the desired character or value. A setting of 0xFF indicates the Enable Character is not used (not available).

1. Determine the desired character or value.
2. Use the [ASCII Chart on page 343](#) on the inside back cover of this manual to find the hex equivalent for the desired character/value.
3. Go to [page 54](#) and scan the ENTER/EXIT PROGRAMMING MODE bar code to enter Programming Mode.
4. Scan the bar code: SELECT ENABLE CHARACTER SETTING on [page 54](#).
5. Scan the appropriate two alphanumeric characters from the keypad in [Appendix D, Keypad](#), that represent the desired character/value determined above. The second character will cause a two-beep indication.
6. Scan the ENTER/EXIT PROGRAMMING MODE bar code to exit Programming Mode.

This completes the procedure. See the table below for examples of how to set this feature.

**Table 11. Enable Character Setting Examples**

STEP	ACTION	EXAMPLES			
1	Desired character/value	'e'	'}'	'E'	Enable Command Not Used
2	Hex equivalent from ASCII Chart on page 343	0x65	0x7D	0x45	0xFF
3	Scan ENTER/EXIT PROGRAMMING MODE				
4	Scan SELECT ENABLE CHARACTER SETTING				
5	Scan Two Characters From Appendix D, Keypad	'6' and '5'	'7' and 'D'	'4' and '5'	'F' and 'F'
6	Scan ENTER/EXIT PROGRAMMING MODE				

# Keyboard Interface

## Wedge Quiet Interval

Specifies the amount of time the scanner looks for keyboard activity before it breaks the keyboard connection in order to transmit data to host. The range is from 0 to 990ms in 10ms increments.



This feature applies **ONLY** to the Keyboard Wedge interface.

### NOTE

1. Determine the desired setting in milliseconds.
2. Divide the desired setting by 10 (setting is in 10ms increments). Pad the result with leading zeroes to yield two digits. For example: 0 = 00, 5 = 05, 20 = 20, etc.
3. Go to [page 82](#) and scan the ENTER/EXIT PROGRAMMING MODE bar code to enter Prog. Mode.
4. Scan the bar code: SELECT WEDGE QUIET INTERVAL SETTING on [page 82](#).
5. Scan the appropriate two digits from the keypad in [Appendix D, Keypad](#), that represent the duration which was determined in the steps above. You will hear a two-beep indication after the last character.



If you make a mistake before the last character, scan the **CANCEL** bar code to abort and not save the entry string. You can then start again at the beginning.

### NOTE

6. Scan the ENTER/EXIT PROGRAMMING MODE bar code to exit.

This completes the procedure to set the Wedge Quiet Interval. See the table below for examples of how to set this feature.

**Table 12. Wedge Quiet Interval Setting Examples**

STEP	ACTION	EXAMPLES			
1	Desired Setting	10ms	150ms	600ms	850ms
2	Divide by 10 (and pad with leading zeroes)	01	15	60	85
3	Scan ENTER/EXIT PROGRAMMING MODE				
4	Scan SELECT WEDGE QUIET INTERVAL SETTING				
5	Scan Two Characters From Appendix D, Keypad	'0' and '1'	'1' and '5'	'6' and '0'	'8' and '5'
6	Scan ENTER/EXIT PROGRAMMING MODE				

## Intercharacter Delay

This parameter specifies the intercharacter delay between the end of one character and the beginning of the next. The delay can be set within a range of zero (0) to 990 milliseconds in 10ms increments. A setting of zero specifies no delay.



This feature applies **ONLY** to the Keyboard Wedge interface.

### NOTE

To set the delay:

1. Determine the desired setting in milliseconds.
2. Divide the desired setting by 10 (setting is in 10ms increments). Pad the result with leading zeroes to yield two digits. For example: 0 = 00, 5 = 05, 20 = 20, etc.
3. Go to [page 83](#) and scan the ENTER/EXIT PROGRAMMING MODE bar code to enter Programming Mode.
4. Scan the bar code: SELECT INTERCHARACTER DELAY SETTING on [page 83](#).
5. Scan the appropriate two digits from the keypad in [Appendix D, Keypad](#), that represent the duration which was determined in the steps above. You will hear a two-beep indication after the last character.



If you make a mistake before the last character, scan the **CANCEL** bar code to abort and not save the entry string. You can then start again at the beginning.

### NOTE

6. Scan the ENTER/EXIT PROGRAMMING MODE bar code to exit Programming Mode.

This completes the procedure. See the table below for examples of how to set this feature.

**Table 13. Intercharacter Delay Setting Examples**

STEP	ACTION	EXAMPLES			
1	Desired Setting	50ms	150ms	600ms	850ms
2	Divide by 10 (and pad with leading zeroes to yield two-digits)	05	15	60	85
3	Scan ENTER/EXIT PROGRAMMING MODE				
4	Scan SELECT INTERCHARACTER DELAY SETTING				
5	Scan Two Characters From Appendix D, Keypad	'0' and '5'	'1' and '5'	'6' and '0'	'8' and '5'
6	Scan ENTER/EXIT PROGRAMMING MODE				

## Intercode Delay

Specifies the delay between labels transmitted to the host for this interface. The selectable range for this feature is from 0 to 99 seconds.

Follow these instructions to set this feature:

1. Determine the desired setting.
2. Pad the number with leading zeroes to yield two digits. For example: 0 = 00, 5 = 05, 20 = 20, etc
3. Go to [page 84](#) and scan the ENTER/EXIT PROGRAMMING MODE bar code to enter Programming Mode.
4. Scan the bar code: SELECT INTERCODE DELAY SETTING on [page 84](#).
5. Scan the appropriate two digits from the keypad in [Appendix D, Keypad](#), that represent the duration which was determined in the steps above. You will hear a two-beep indication after the last character.



### NOTE

If you make a mistake before the last character, scan the CANCEL bar code to abort and not save the entry string. You can then start again at the beginning.

6. Scan the ENTER/EXIT PROGRAMMING MODE bar code to exit Programming Mode.

This completes the procedure. See the table below for examples of how to set this feature.

**Table 14. Wedge Intercode Delay Examples**

STEP	ACTION	EXAMPLES			
1	Desired Setting	No Delay	5 Seconds	60 Seconds	99 Seconds
2	Pad with leading zero(es)	00	05	60	99
3	Scan ENTER/EXIT PROGRAMMING MODE				
4	Scan SELECT INTERCODE DELAY SETTING				
5	Scan Two Characters From Appendix D, Keypad	'0' and '0'	'0' and '5'	'6' and '0'	'9' and '9'
6	Scan ENTER/EXIT PROGRAMMING MODE				

# Data Format

## Data Editing

When a bar code is scanned, additional information can be sent to the host computer along with the bar code data. This combination of bar code data and supplementary user-defined data is called a “message string.” The Data Editing features can be used to build specific user-defined data into a message string. There are several types of selectable data characters that can be sent before and after scanned data. You can specify if they should be sent with all symbologies, or only with specific symbologies. The following shows the available elements you can add to a message string:

**Figure 18. Breakdown of a Message String**

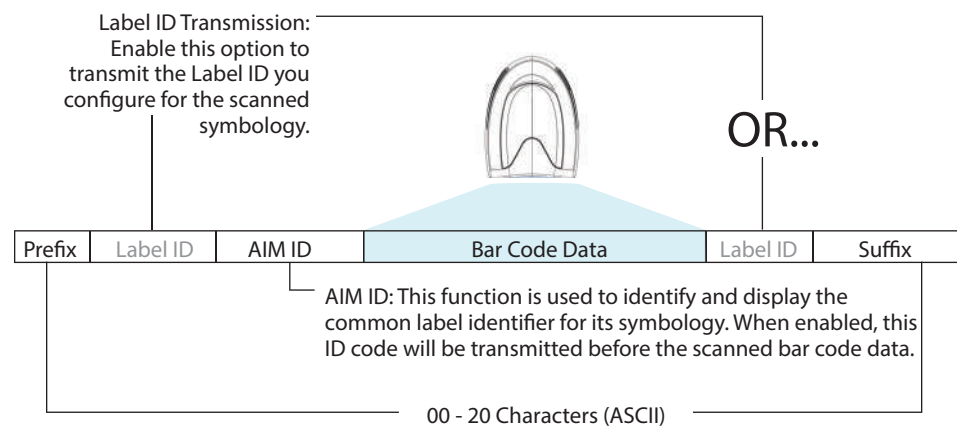

### NOTE

**Additional advanced editing is available. See the Advanced formatting features in the Datalogic Aladdin configuration software, or contact Technical Support (see page 2) for more information.**

### Please Keep In Mind...

- Modifying a message string is not a mandatory requirement. Data editing is a sophisticated feature allowing highly customizable output for advanced users. Factory default settings for data editing is typically set to NONE.
- A prefix or suffix may be applied only to a specified symbology (reference [1D Symbologies](#), starting on page 113) or across all symbologies (set via the Global features in [Configuration Using Bar Codes](#), starting on page 37).
- You can add any character from the [ASCII Chart on page 343](#) (from 00–FF) on the inside back cover of this manual as a prefix, suffix or Label ID.
- Enter prefixes and suffixes in the order in which you want them to appear on the output.

## Global Prefix/Suffix

Up to 20 ASCII characters may be added as a prefix (in a position before the bar code data) and/or as a suffix (in a position following the bar code data) as indicated.

Figure 19. Prefix and Suffix Positions

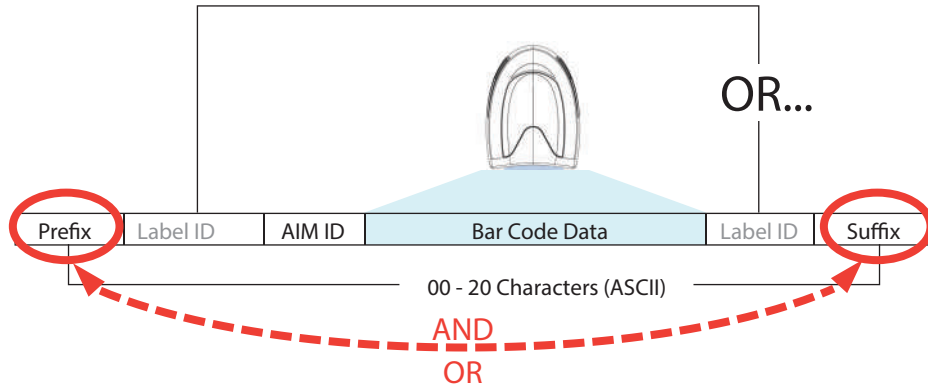

### Example: Setting a Prefix

In this example, we'll set a prefix for all symbologies.

1. Determine which ASCII character(s) are to be added to scanned bar code data. In this example, we'll add a dollar sign ('\$') as a prefix.
2. Go to [page 76](#) and scan the ENTER/EXIT PROGRAMMING MODE bar code, then scan the SET GLOBAL PREFIX bar code.
3. Reference the [ASCII Chart on page 343](#) on the inside back cover of this manual to find the hex value assigned to the desired character. The corresponding hex number for the '\$' character is 24. To enter this selection code, scan the '2' and '4' bar codes from [Appendix D, Keypad](#).



#### NOTE

If you make a mistake before the last character, scan the CANCEL bar code to abort and not save the entry string. You can then start again at the beginning.

4. If less than the expected string of 20 characters are selected, scan the ENTER/EXIT bar code to terminate the string.
5. Scan the ENTER/EXIT bar code once again to exit Programming Mode.
6. The resulting message string would appear as follows:  
Scanned bar code data: 12345  
Resulting message string output: \$12345



## Global AIM ID



This feature enables/disables addition of AIM IDs for all symbology types.

### NOTE

AIM label identifiers (as opposed to custom characters you select yourself as with label identifiers) can be included with scanned bar code data. AIM label identifiers consist of three characters as follows:

- A close brace character (ASCII ‘}’), followed by...
- A code character (see the table below), followed by...
- A modifier character (the modifier character is symbol dependent).

SYMBOLGY	CHAR	SYMBOLGY	CHAR
UPC/EAN	E <sup>a</sup>	Code 128/GS1-128	C
Code 39 and Code 32	A	DataBar Omnidirectional, DataBar Expanded	e
Codabar	F	Standard 2 of 5	S
Interleaved 2 of 5	I	ISBN	X <sup>b</sup>
Code 93	G	Code 11	H

- UPC-A and UPC-E labels are converted to EAN 13 when adding AIM IDs.
- ISBN (X with a 0 modifier character)

Figure 20. AIM ID

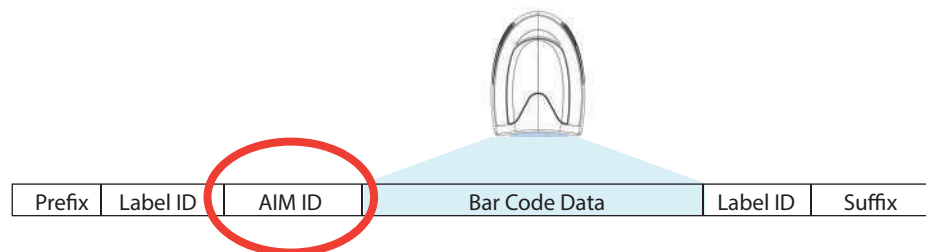

## Label ID

A Label ID is a customizable code of up to three ASCII characters (each can be one of hex 0x01–0xFF), used to identify a bar code (symbology) type. It can be appended previous to or following the transmitted bar code data depending upon how this option is enabled. This feature provides options for configuring custom Label IDs as a pre-loaded set or individually per symbology (see "Label ID: Set Individually Per Symbology" on page 79). If you wish to program the scanner to always include an industry standard label identifier for ALL symbology types, see "Global AIM ID" on page 77.

### Label ID: Pre-loaded Sets

The following table lists the pre-loaded label ID sets for the USA and Europe.

**Table 15. Label ID Pre-loaded Sets**

Symbology	USA Label ID set		EU Label ID set	
	ASCII character	Hex value	ASCII character	Hexadecimal value
ABC Codabar	S	530000	S	530000
CODABAR	%	250000	R	520000
Code 39 CIP	Y	590000	Y	590000
Code 93	&	260000	U	550000
CODE11	CE	434500	b	620000
CODE128	#	230000	T	540000
CODE32	A	410000	X	580000
CODE39	*	2A0000	V	560000
CODE4	4	340000	4	340000
CODE5	j	6A0000	j	6A0000
CODE93	&	260000	U	550000
DATALOGIC 20F5	s	730000	s	730000
EAN13	F	460000	B	420000
EAN13 P2	F	460000	L	4C0000
EAN13 P5	F	460000	M	4D0000
EAN8	FF	464600	A	410000
EAN8 P2	FF	464600	J	4A0000
EAN8 P5	FF	464600	K	4B0000
FOLLETT 20F5	O	4F0000	O	4F0000
GS1 DATABAR EXPANDED	RX	525800	t	740000
GS1 DATABAR LIMITED	RL	524C00	v	760000

Symbology	USA Label ID set		EU Label ID set	
GS1 DATABAR OMNIDIRECTIONAL	R4	523400	u	750000
GS1-128		000000	k	6B0000
I2OF5	i	690000	N	4E0000
IATA	IA	494100	&	260000
Industrial 2 of 5	W	570000	W	570000
Interleaved 2 of 5 CIP HR	e	650000	e	650000
ISBN	l	490000	@	400000
ISBT128	f	660000	f	660000
ISSN	n	6E0000	n	6E0000
MSI	@	400000	Z	5A0000
S25	s	730000	P	500000
UPCA	A	410000	C	430000
UPCA P2	A	410000	F	460000
UPCA P5	A	410000	G	470000
UPCE	E	450000	D	440000
UPCE P2	E	450000	H	480000
UPCE P5	E	450000	I	490000

## Label ID: Set Individually Per Symbology

To configure a Label ID individually for a single symbology:

1. Scan the ENTER/EXIT bar code.
2. Select Label ID position as either BEFORE (Enable as Prefix) or AFTER (Enable as suffix) by scanning the appropriate bar code in the section "Label ID Control" on page 79. Reference Figure 21 for Label ID positioning options if multiple identification features are enabled.
3. Scan a bar code to select the symbology for which you wish to configure a custom Label ID from the section [Label ID Symbology Selection, starting on page 80](#).
4. Determine the desired character(s) (you may choose up to three) which will represent the Label ID for the selected symbology.
5. Turn to the [ASCII Chart on page 343](#) on the inside back cover of this manual and find the equivalent hex digits associated with your choice of Label ID. For example, if you wish to select an equal sign (=) as a Label ID, the chart indicates its associated hex characters as 3D. Turn to [Keypad, starting on page 335](#) and scan the bar codes representing the hex characters determined. For the example given, the characters '3' and 'D' would be scanned. More examples of Label ID settings are provided in [Table 16](#).



### NOTE

If you make a mistake before the last character, scan the CANCEL bar code to abort and not save the entry string. You can then start again at the beginning.

6. Scan the ENTER/EXIT bar code to exit Label ID entry.
7. Scan the ENTER/EXIT bar code once again to exit Programming Mode.

This completes the steps to configure a Label ID for a given symbology.

**Figure 21. Label ID Position Options**

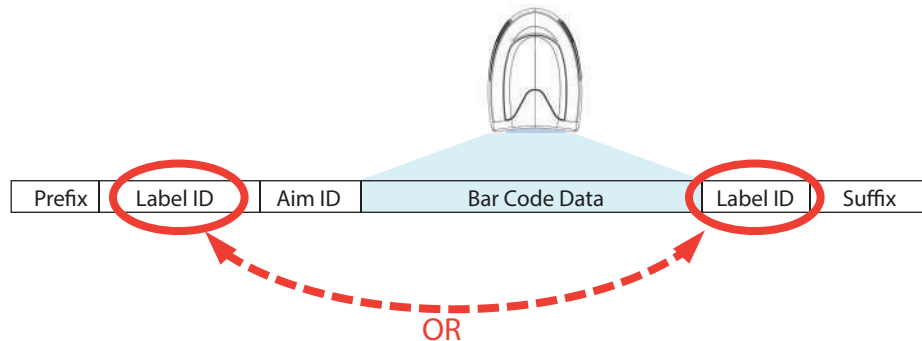

## Label ID: Set Individually Per Symbology — continued

Table 16. Label ID Examples

STEP	ACTION	EXAMPLES			
1.	Scan the ENTER/EXIT bar code	(Scanner enters Programming Mode)			
2.	Determine placement of the Label ID characters BEFORE or AFTER with regard to scanned data using "Label ID Control" on page 79	Enable as Prefix	Enable as Suffix	Enable as Prefix	Enable as Suffix
3.	Scan the bar code selecting the symbology type you wish to designate label ID characters for using Label ID Symbology Selection, starting on page 80.	GS1 DataBar Omnidirectional	Code 39	Interleaved 2 of 5	Code 32
4.	Custom Label ID example (desired characters):	D B *	= C 3	+	P H
5.	Find hex equivalents from the ASCII table (inside back cover), then scan in these digits/characters using the bar codes in the section: Keypad, starting on page 335. If you make a mistake before the last character, scan the CANCEL bar code to abort and not save the entry string. You can then start again at the beginning.	44 42 2A	3D 43 33	2B	50 48
6.	Scan the ENTER/EXIT bar code	(Scanner exits Label ID entry)			
7.	Scan the ENTER/EXIT bar code once again	(Scanner exits Programming Mode)			
<b>Result:</b>					
		DB*[bar code data]	[bar code data]=C3	+ [bar code data]	[bar code data]PH

---

## Character Conversion

Character conversion is an eight byte configuration item. The eight bytes are 4 character pairs represented in hexadecimal ASCII values. The first character in the pair is the character that will be converted. The second character in the pair is the character to convert to. If the character to convert in a pair is FF, then no conversion is done.

For example, if you have the character conversion configuration item set to the following: 41423132FFFFFFFF

The first pair is 4142 or AB (41 hex is an ASCII capital A, 42 hex is an ASCII capital B) and the second pair is 3132 or 12 (31 hex is an ASCII 1, 32 is an ASCII 2). The other two pairs are FFFF and FFFF.

With the label, AB12BA21, it would look as follows after the character conversion: BB22BB22.

The A characters were converted to B characters and the 1 characters were converted to 2 characters. Nothing is done with the last two character pairs, since they are all FF.

To set Character Conversion:

1. Scan the ENTER/EXIT bar code.
2. Scan the bar code for "Character Conversion" on page 86
3. Determine the desired string. Sixteen positions must be determined as in the above example. Next, turn to the [ASCII Chart on page 343](#) on the inside back cover of this manual and find the equivalent hex digits needed to fulfill the string.
4. Turn to [Appendix D, Keypad](#) and scan the bar codes representing the hex characters determined in the previous step.
5. Scan the ENTER/EXIT bar code to exit Programming Mode.



### NOTE

If less than the expected string of 16 characters are selected, scan the ENTER/EXIT bar code twice to accept the selections and exit Programming Mode.

## Scanning Features

### Good Read LED Duration

This feature specifies the amount of time that the Good Read LED remains on following a good read. The good read LED on time can be set within a range of 10 milliseconds to 2,550 milliseconds (0.001 to 2.55 seconds) in 100ms increments.

Follow these instructions to set this feature:

1. Determine the desired setting in milliseconds. A setting of 0 means that the good read LED stays on until the next time the trigger is pulled.
2. Divide the desired setting by 10 (setting is in 100ms increments). Pad the result with leading zeroes to yield three digits. For example: 0 = 000, 5 = 000, 20 = 020, etc.
3. Go to page 100 and scan the ENTER/EXIT PROGRAMMING MODE bar code to enter Programming Mode.
4. Scan the bar code: SELECT GOOD READ LED DURATION SETTING.
5. Scan the appropriate three digits from the keypad in Appendix D, Keypad representing the duration which was determined in the steps above. You will hear a two-beep indication after the last character.



#### NOTE

If you make a mistake before the last character, scan the CANCEL bar code to abort and not save the entry string. You can then start again at the beginning.

6. Scan the ENTER/EXIT PROGRAMMING MODE bar code to exit Programming Mode.

This completes the procedure. See the following table for some examples of how to set this feature.

**Table 17 - Good Read LED Duration Setting Example**

STEP	ACTION	EXAMPLES			
1	Desired Setting	Good Read LED stays on until next trigger pull (00)	20ms	150ms	2550ms (2.55 sec.)
2	Divide by 10 (and pad with leading zeroes)	000	002	015	255
3	Scan ENTER/EXIT PROGRAMMING MODE				
4	Scan SELECT GOOD READ LED DURATION SETTING				
5	Scan Three Characters From Appendix D, Keypad	'0', '0' and '0'	'0', '0' and '2'	'0', '1' and '5'	'2', '5' and '5'
6	Scan ENTER/EXIT PROGRAMMING MODE				

## Scan Mode

Selects the scan operating mode for the reader. Selections are:

**Trigger Single:** When the trigger is pulled, scanning is activated until one of the following occurs:

- **Stand Mode Indication** has elapsed
- a label has been read
- the trigger is released

This mode is associated with typical handheld reader operation: when the trigger is pulled, scanning starts and the product scans until the trigger is released, or a label is read, or the maximum **Stand Mode Indication** has elapsed.

**Trigger Hold Multiple :** When the trigger is pulled, scanning starts and the product scans until the trigger is released or **Stand Mode Indication** has elapsed. Reading a label does not disable scanning. **Double Read Timeout** prevents undesired multiple reads of the same label while in this mode.

**Trigger Pulse Multiple:** When the trigger is pulled, continuous scanning is activated until **Stand Mode Indication** has elapsed or the trigger has been released and pulled again. **Double Read Timeout** prevents undesired multiple reads of the same label while in this mode.

**Flashing:** The reader flashes<sup>1</sup> on and off regardless of the trigger status. Flash rate is controlled by **Flash On Time** and **Flash Off Time**. When Flash is ON the reader reads continuously. When Flash is OFF scanning is deactivated.

**Always On:** No trigger pull is required to read a bar code. Scanning is continually on. **Double Read Timeout** prevents undesired multiple reads of the same label while in this mode.

**Stand Mode:** No trigger pull is required to read a bar code. Scanning turns on automatically when an item is placed in reader's field of view. While in a stand watch state, the reader illumination LED goes from dim to maximum bright.

<sup>1</sup>Controlled by **Flash On Time**.



## Scanning Active Time

This setting specifies the amount of time that the reader stays in scan ON state once the state is entered. The range for this setting is from 1 to 255 seconds in 1-second increments.

Follow these instructions to set this feature:

1. Determine the desired setting.
2. Pad the result with leading zeroes to yield three digits. For example: 0 = 000, 5 = 005, 20 = 020, etc.
3. Scan the ENTER/EXIT PROGRAMMING MODE bar code to enter Programming Mode.
4. Scan the bar code: SELECT SCANNING ACTIVE TIME SETTING on [page 118](#).
5. Scan the appropriate three digits from the keypad in [Appendix D, Keypad](#) that represent the duration which was determined in the steps above. You will hear a two-beep indication after the last character.



### NOTE

If you make a mistake before the last character, scan the CANCEL bar code to abort and not save the entry string. You can then start again at the beginning.

6. Scan the ENTER/EXIT PROGRAMMING MODE bar code to exit Programming Mode.

This completes the procedure. See the table below for examples of how to set this feature.

**Table 18. Scanning Active Time Setting Examples**

STEP	ACTION	EXAMPLES			
1	Desired Setting	1 Second	90 Sec. (1.5 min.)	180 Sec. (3 min.)	255 Seconds (4.25 min.)
2	Pad leading zero(es)	001	090	180	255
3	Scan ENTER/EXIT PROGRAMMING MODE				
4	Scan SELECT SCANNING ACTIVE TIME SETTING				
5	Scan Three Characters From Appendix D, Keypad	'0', '0' and '1'	'0', '9' and '0'	'1', '8' and '0'	'2', '5' and '5'
6	Scan ENTER/EXIT PROGRAMMING MODE				

## Aiming Duration Time

Specifies the frame of time the aiming pointer remains on after decoding a label, when in trigger single mode. The range for this setting is from 1 to 255 seconds in 1-second increments.

Follow these instructions to set this feature:

1. Determine the desired setting.
2. Pad the result with leading zeroes to yield three digits. For example: 0 = 000, 5 = 005, 20 = 020, etc.
3. Go to [page 108](#) and scan the ENTER/EXIT PROGRAMMING MODE bar code to enter Programming Mode.
4. Scan the bar code: SELECT AIMING DURATION TIME SETTING.
5. Scan the appropriate three digits from the keypad in [Appendix D, Keypad](#), that represent the duration which was determined in the steps above. You will hear a two-beep indication after the last character.



### NOTE

If you make a mistake before the last character, scan the CANCEL bar code to abort and not save the entry string. You can then start again at the beginning.

6. Scan the ENTER/EXIT PROGRAMMING MODE bar code to exit Programming Mode.

This completes the procedure. See [Table 19](#) for some examples of how to set this feature.

**Table 19. Aiming Duration Time Setting Examples**

STEP	ACTION	EXAMPLES			
1	Desired Setting	1 Second	90 Sec. (1.5 min.)	180 Sec. (3 min.)	255 Seconds (4.25 min.)
2	Pad leading zero(es)	001	090	180	255
3	Scan ENTER/EXIT PROGRAMMING MODE				
4	Scan SELECT AIMING DURATION TIME SETTING				
5	Scan Three Characters From Appendix D, Keypad	'0', '0' and '1'	'0', '9' and '0'	'1', '8' and '0'	'2', '5' and '5'
6	Scan ENTER/EXIT PROGRAMMING MODE				

## Flash On Time

This feature specifies the ON time for the indicator LED while in Flash Mode. The selectable range is 100 to 9,900 milliseconds (0.1 to 9.9 seconds), in 100 millisecond increments.

Follow these instructions to set this feature.

1. Determine the desired setting in milliseconds.
2. Divide the desired setting by 100 (setting is in 100ms increments). Pad the result with leading zeroes to yield two digits. For example: 0 = 00, 5 = 05, 20 = 20, etc.
3. Scan the ENTER/EXIT PROGRAMMING MODE bar code to enter Programming Mode.
4. Scan the bar code: SELECT FLASH ON TIME SETTING on [page 116](#)
5. Scan the appropriate two digits from the keypad in [Appendix D, Keypad](#) representing the duration which was determined in the steps above. You will hear a two-beep indication after the last character.



**If you make a mistake before the last character, scan the CANCEL bar code to abort and not save the entry string. You can then start again at the beginning.**

### NOTE

6. Scan the ENTER/EXIT PROGRAMMING MODE bar code to exit Programming Mode.

This completes the procedure. See the table below for examples of how to set this feature.

**Table 20. Flash On Time Setting Examples**

STEP	ACTION	EXAMPLES			
1	<b>Desired Setting</b>	500ms	1,000ms (1 sec.)	5200ms (5.2 sec.)	9,900ms (9.9 sec.)
2	<b>Divide by 100 (and pad with leading zeroes to yield two digits)</b>	05	10	52	99
3	<b>Scan ENTER/EXIT PROGRAMMING MODE</b>				
4	<b>Scan SELECT FLASH ON TIME SETTING</b>				
5	<b>Scan Two Characters From Appendix D, Keypad</b>	'0' and '5'	'1' and '0'	'5' and '2'	'9' and '9'
6	<b>Scan ENTER/EXIT PROGRAMMING MODE</b>				

## Flash Off Time

This feature specifies the OFF time for the indicator LED while in Flash Mode. The selectable range is 100 to 9,900 milliseconds (0.1 to 9.9 seconds), in 100 millisecond increments.

Follow these instructions to set this feature.

1. Determine the desired setting in milliseconds.
2. Divide the desired setting by 100 (setting is in 100ms increments). Pad the result with leading zeroes to yield two digits. For example: 0 = 00, 5 = 05, 20 = 20, etc.
3. Scan the ENTER/EXIT PROGRAMMING MODE bar code to enter Programming Mode.
4. Scan the bar code: SELECT FLASH OFF TIME SETTING on [page 117](#).
5. Scan the appropriate two digits from the keypad in [Appendix D, Keypad](#), that represent the duration which was determined in the steps above. You will hear a two-beep indication after the last character.



### NOTE

If you make a mistake before the last character, scan the CANCEL bar code to abort and not save the entry string. You can then start again at the beginning.

6. Scan the ENTER/EXIT PROGRAMMING MODE bar code to exit Programming Mode.

This completes the procedure. See the table below for examples of how to set this feature.

**Table 21. Flash Off Time Setting Examples**

STEP	ACTION	EXAMPLES			
1	Desired Setting	500ms	1,000ms (1 sec.)	5200ms (5.2 sec.)	9,900ms (9.9 sec.)
2	Divide by 100 (and pad with leading zeroes to yield two digits)	05	10	52	99
3	Scan ENTER/EXIT PROGRAMMING MODE				
4	Scan SELECT FLASH OFF TIME SETTING				
5	Scan Two Characters From Appendix D, Keypad	'0' and '5'	'1' and '0'	'5' and '2'	'9' and '9'
6	Scan ENTER/EXIT PROGRAMMING MODE				

## RF Features

### Automatic Configuration Update

When this feature is enabled, the base station and reader will keep their configurations synchronized. If a reader's configuration is altered by reading programming labels, this change is automatically transferred and updated in a linked base station. Likewise, if the base station's configuration is changed using Aladdin or by host commands, then the reader's configuration will automatically be updated if this feature is enabled.

### RF Address Stamping

#### Source Radio Address Delimiter Character

This option specifies the delimiter character to be placed between the label data and radio address when address stamping is enabled.



This feature only applies if "Source Radio Address Transmission" on page 249 is enabled.

#### NOTE

Follow these instructions to select the delimiter character:

1. Determine the desired character, then find its hexadecimal equivalent on the [ASCII Chart](#) on the inside back cover. A setting of 00 specifies no delimiter character.
2. Go to [page 250](#) and scan the ENTER/EXIT PROGRAMMING MODE bar code to enter Programming Mode.
3. Scan the bar code: SET SOURCE RADIO ADDRESS DELIMITER CHARACTER.
4. Scan the appropriate two digits from the keypad in [Appendix D, Keypad](#), that represent the hexadecimal characters which were determined in the steps above. You will hear a two-beep indication after the last character.



If you make a mistake before the last character, scan the CANCEL bar code to abort and not save the entry string. You can then start again at the beginning.

#### NOTE

5. Scan the ENTER/EXIT PROGRAMMING MODE bar code to exit.

**Table 22. Source Radio Address Delimiter Character Setting Examples**

STEP	ACTION	EXAMPLES			
1	Desired Setting	No delimiter character	, (comma)	- (dash)	/ (slash)
2	Scan ENTER/EXIT PROGRAMMING MODE				
3	Scan SET SOURCE RADIO ADDRESS DELIMITER CHARACTER				
4	Scan Two Characters From Appendix D, Keypad	'0' and '0'	'2' and 'C'	'2' and 'D'	'2' AND 'F'
5	Scan ENTER/EXIT PROGRAMMING MODE				

## STAR Radio Protocol Timeout

This parameter sets the valid wait time before transmission between the hand-held reader and Base Station is considered failed.

When setting this parameter, take into consideration the radio traffic (number of readers in the same area). The selectable range for this feature is from 02 to 25 seconds.

Follow these instructions to set this feature:

1. Determine the desired setting.
2. Pad the number with leading zeroes to yield two digits. For example: 2 = 02, 5 = 05, 25 = 25, etc
3. Go to [page 259](#) and scan the ENTER/EXIT PROGRAMMING MODE barcode to enter Programming Mode.
4. Scan the barcode: SELECT RADIO PROTOCOL TIMEOUT.
5. Scan the appropriate two digits from the keypad in [Appendix D, Keypad](#), that represent the duration which was determined in the steps above. You will hear a two-beep indication after the last character.



### NOTE

If you make a mistake before the last character, scan the CANCEL barcode to abort and not save the entry string. You can then start again at the beginning.

6. Scan the ENTER/EXIT PROGRAMMING MODE barcode to exit Programming Mode.

This completes the procedure. See [Table 23](#) for some examples of how to set this feature.

**Table 23. STAR Radio Protocol Timeout Examples**

STEP	ACTION	EXAMPLES			
1	Desired Setting	2 Seconds	5 Seconds	10 Seconds	25 Seconds
2	Pad with leading zero(es)	02	05	10	25
3	Scan ENTER/EXIT PROGRAMMING MODE				
4	Scan SELECTSTAR RADIO PROTOCOL TIMEOUT SETTING				
5	Scan Two Characters From Appendix D, Keypad	'0' and '2'	'0' and '5'	'1' and '0'	'2' AND '5'
6	Scan ENTER/EXIT PROGRAMMING MODE				

## BT-Only Features

### BT Pin Code

This option specifies the 4-character or 16-character pin code to be used for authentication of the BT link. To set the pin code:

1. Scan the ENTER/EXIT PROGRAMMING MODE bar code to enter Programming Mode, then enable "BT Security Mode" on page 251.
2. Specify the desired pin code length (4 or 16) by scanning the appropriate bar code in "Select PIN Code Length" on page 252.
3. Determine the desired characters. For example, D254 or STOR12345678135M
4. Convert the characters to hexadecimal using the [ASCII Chart](#) on the inside back cover of this manual.
5. Go to [page 252](#) and Scan the bar code: SET 4 CHAR PIN CODE or SET 16-CHAR PIN CODE.
6. Scan the appropriate alphanumeric characters from the keypad in [Appendix D, Keypad](#), representing the hexadecimal entries determined in the steps above. You will hear a two-beep indication after the last character.



If you make a mistake before the last character, scan the CANCEL bar code to abort and not save the entry string. You can then start again at the beginning.

#### NOTE

7. Scan the ENTER/EXIT PROGRAMMING MODE bar code to exit Programming Mode.



Changing the pin code setting will unlink the devices. If the Automatic Configuration Update is set to the default enabled setting, the devices must only be relinked. If the Automatic Configuration Update is set to the disabled setting, the Pin Code setting must also be updated in the Base Station using Aladdin. After the Base Station has been updated, the devices must be relinked.

#### NOTE

**Table 24. BT Pin Code Setting Examples**

STEP	ACTION	EXAMPLES	
1	Desired Setting	D254	STOR12345678135M
2	Convert the characters to hexadecimal	44 32 35 34	53 54 4F 52 31 32 33 34 35 36 37 38 31 33 35 4D
3	Scan ENTER/EXIT PROGRAMMING MODE		
4	Scan SET BT PIN CODE		
5	Scan 8 or 32 Alphanumeric Characters From Appendix D, Keypad	44323534	53544F5231323334353637383133354D
6	Scan ENTER/EXIT PROGRAMMING MODE		

# Symbologies

## Set Length

Length Control allows you to select either variable length decoding or fixed length decoding for the specified symbology.

**Variable Length:** For variable length decoding, a minimum and maximum length may be set.

**Fixed Length:** For fixed length decoding, two different lengths may be set.

### Set Length 1

This feature specifies one of the bar code lengths for a given symbology. Length 1 is the minimum label length if in Variable Length Mode, or the first fixed length if in Fixed Length Mode.

Reference the [1D Symbologies on page 113](#) section to view the selectable range (number of characters) for the symbology being set.

Follow these instructions to set this feature:

1. Determine the desired character length. Pad the number with leading zeroes to yield two digits. For example: 0 = 00, 5 = 05, 20 = 20, etc.
2. Scan the ENTER/EXIT PROGRAMMING MODE bar code to enter Programming Mode.
3. Scan the “Select Length 1 Setting” for the symbology being set.
4. Scan the appropriate two digits from the keypad in [Appendix D, Keypad](#), that represent the length setting which was determined in the steps above. You will hear a two-beep indication after the last character.



#### NOTE

If you make a mistake before the last character, scan the CANCEL bar code to abort and not save the entry string. You can then start again at the beginning.

5. Scan the ENTER/EXIT PROGRAMMING MODE bar code to exit Programming Mode.

This completes the procedure. See the table below for examples of how to set this feature.

**Table 25. Length 1 Setting Examples**

STEP	ACTION	EXAMPLES			
1	<b>Desired Setting</b>	01 Character	07 Characters	52 Characters	74 Characters
2	<b>Scan ENTER/EXIT PROGRAMMING MODE</b>				
3	<b>Scan SELECT LENGTH 1SETTING for the desired symbology</b>				
4	<b>Scan Two Characters From Appendix D, Keypad</b>	'0' and '1'	'0' and '7'	'5' and '2'	'7' AND '4'
5	<b>Scan ENTER/EXIT PROGRAMMING MODE</b>				



## Set Length 2

This feature specifies one of the bar code lengths for a given symbology. Length 2 is the maximum label length if in Variable Length Mode, or the second fixed length if in Fixed Length Mode.

Reference the [1D Symbologies on page 113](#) section to view the selectable range (number of characters) for the symbology being set. A setting of 00 specifies to ignore this length (only one fixed length).

Follow these instructions to set this feature:

1. Determine the desired character length. Pad the number with leading zeroes to yield two digits. For example: 0 = 00, 5 = 05, 20 = 20, etc.
2. Scan the ENTER/EXIT PROGRAMMING MODE bar code to enter Programming Mode.
3. Scan the “Select Length 2 Setting” for the symbology being set.
4. Scan the appropriate two digits from the keypad in [Appendix D, Keypad](#), that represent the length setting which was determined in the steps above. You will hear a two-beep indication after the last character.



### NOTE

If you make a mistake before the last character, scan the CANCEL bar code to abort and not save the entry string. You can then start again at the beginning.

5. Scan the ENTER/EXIT PROGRAMMING MODE bar code to exit Programming Mode.

This completes the procedure. See the table below for examples of how to set this feature.

**Table 26. Length 2 Setting Examples**

STEP	ACTION	EXAMPLES			
1	Desired Setting	00 (ignore second length)	07 Characters	52 Characters	74 Characters
2	Scan ENTER/EXIT PROGRAMMING MODE				
3	Scan SELECT LENGTH 2 SETTING				
4	Scan Two Characters From Appendix D, Keypad	'0' and '0'	'0' and '7'	'5' and '2'	'7' and '4'
5	Scan ENTER/EXIT PROGRAMMING MODE				

# NOTES



# Chapter 5

## Message Formatting

### Message Formatting



Message Formatting is only available for the Gryphon™ Wireless model.

#### NOTE

A message from the Host to the base must follow these rules:

- If Address stamping options or address delimiter are enabled on the base, the Host replay must have address field and delimiter too. Otherwise the message will be ignored. Address delimiter is present only when address stamping is enabled.
- Address stamping is necessary to correctly route the message to the Gryphon I, especially when more than one handheld is linked to the same base. Address stamping could be disabled if the system is in point to point configuration. If address stamping is not enabled, the messages are addressed to the first handheld linked to the base.
- The maximum character length for messages is 48.
- Messages end with “CR” 0x0D ASCII character. The CR character cannot be contained in the middle.
- Messages cannot start with '\$' or # because these are reserved for Service mode command
- Base station can receive host message only if Host Commands Obey/Ignore is set to Ignore.
- Message could be sent to the HH in response to a Label when “Transmit mode” require Ack from Host (see transmit mode parameter) or at any time. When messages are sent not in response to a label must start with DC2 0x12 ASCII character and could be sent in any transmit mode setting.
- Message could be sent to all HH linked to base by using a Multicast message:  
“00 00 00 00 2A AA”
- In order to receive a message, handhelds must not be in sleep state.

The format of the ACK from Host message (used for transmission mode 02) is:  
[Scanner\_Addr] [Scanner\_Addr\_delimiter] MESSAGE <CR>

The format of a generic message From Host to HH is:

---

[Scanner\_Addr] [Scanner\_Addr\_delimiter] DC2 MESSAGE <CR>  
where DC2 is ASCII 0x12 (^R) character.

[Items in square brackets are optional.]

- If you want to control the Scanner's beeper from the host, you will also probably want to disable the good transmission beep that is emitted when the code is received from the cradle. (See "[Wireless Beeper Features](#)" on page 250).

The message field can store plain text and escape sequences.

- Escape sequences are interpreted as commands.

## LED and Beeper Control

<b>ESC [ 0 q</b>	Emit short High tone + short delay
<b>ESC [ 1 q</b>	Emit short Low tone + short delay
<b>ESC [ 2 q</b>	Emit long Low tone + short delay
<b>ESC [ 3 q</b>	Emit good read tone
<b>ESC [ 4 q</b>	Emit bad tx tone
<b>ESC [ 5 q</b>	Wait 100 ms
<b>ESC [ 6 q</b>	Turn on the green LED
<b>ESC [ 7 q</b>	Turn off the green LED
<b>ESC [ 8 q</b>	Turn on the green spot
<b>ESC [ 9 q</b>	Turn off the green spot
<b>ESC [ 0 r</b>	Beeper for Find me function (new)
<b>ESC [ 1 r</b>	Power-off (new)

The LED control escape sequences are intended to activate the LEDs for short periods of time and can be used in combination with the Beeper. The LED and Beeper will be controlled by the system after the entire command sequence is interpreted.

### Example:

**ESC [ 6 q ESC [ 3 q ESC [ 7 q** Turns on the green LED, emits a good read tone, and turns off the green LED.

**ESC [ 6 q ESC [ 5 q ESC [ 7 q** Turns on the green LED for 100 ms and then turns off the green LED.

Escape sequences different from those listed will be ignored.



# Appendix A

## Technical Specifications

The table below contains Physical and Performance Characteristics, User Environment and Regulatory information. [Table 29](#) provides Standard Cable Pinouts.

**Table 27. Technical Specifications**

Electrical Features	
Power Supply	GD4520: 5 VDC GD4590: 4.5 - 14.0 VDCGBT/GM4500: 5V to 14V +/-5% in the Communication Port 5V to 14V +/-5% in the Aux Power Port <b>NOTE:</b> Aux Power Port is recommended when long cables are connected to Communication Port
Consumption (Typical)	GD45X0: <300 mA @ 5V (operative) <200 mA @ 12V Standby/Idle <90 mA @ 5V <50 mA @ 12V GBT/GM4500: Gun Only: 330 mA @ 3,7V (operative) Cradle Only: 80 mA @ 5V (operative) Cradle with Gun in Charge (scan while charging): 475 mA (PC host USB) 1150 mA (5V on Aux Power Port) 520 mA (12V on Aux Power Port) Gun Charging via micro USB: 480 mA (PC host port, no scan) 900 mA (wall adapter, no scan) 1160 mA (wall adapter, scan while charging)
Battery Capacity	Li-Ion 3.6V, 3250 mAh (11.7W/h)

<b>Electrical Features</b>	
Recharge Time (Typical)	Values valid for a fully depleted battery USB Only: 11h (no Scan) 15h (Scan while Charging) Using Aux Power Port: 3h (no Scan) 3.5h (Scan while Charging) Using micro USB (wall adapter): 2h (no Scan, with Wall Adapter) 4.6h (no Scan, with PC Host)
Max. Scan Rate	50 frames/sec
Reading Indicators	Top and rear illumination, Good Read Spot, Beep, Vibrator

<b>Optical Features</b>	
Optical Format	1/4"
Active Imager Size	3896 um (H) x 2453 um (V)
Active Pixels	1280 H x 800 V
Illumination System	LED source Warm White Emission (wavelength = 350 - 770 nm) Hyper Red Emission (wavelength = 660 nm, DGM model only) IEC 62471 Exempt Risk Group
Aiming System	RED laser source IEC 60825-1 Class 2 Radiation 1 mW Avg., Emitted wavelength 650 nm, 10ms pulse
Ambient Light	Up to 100,000 lux
Tilt Tolerance	0° - 360°
Pitch Tolerance	± 65°

<b>Optical Features (continued)</b>	
Skew Tolerance	± 65
Field of View	36° H x 23° V
PCS (Datalogic Test Chart)	minimum 15%

DOF - Depth of Field (Typical) <sup>a</sup>		
Symbology	SR	HD
Code 39	5 mil: 7.0 - 38.0 cm (2.7" - 14.9") 10 mil: 2.2 - 58.0 cm (0.8" - 22.8") 20 mil: FOV lim. - 110 cm (up to 43.3")	3 mil: 5.0 - 15.0 cm (2.0" - 5.9") 5 mil: 0.5 - 25.0 cm (0.2" - 9.8") 10 mil: 0.5 - 45.0 cm (0.2" - 17.7")
EAN13	7.5 mil: 9.0 - 30.0 cm (3.5" - 11.8") 13 mil: 1.0 - 71.0 cm (0.4" - 27.9")	7.5 mil: 2.0 - 23.5 cm (0.8" - 9.2") 13 mil: 1.0 - 40.0 cm (0.4" - 15.7")
PDF417	6.6 mil: 6.5 - 24.0 cm (2.6" - 9.4") 10 mil: 2.5 - 41.0 cm (1.0" - 16.1") 15 mil: 2.3 - 65.0 cm (0.9" - 25.6")	4 mil: 3.0 - 12.0 cm (1.2" - 4.7") 6.6 mil: 0.5 - 23.5 cm (0.2" - 9.2") 10 mil: 0.5 - 31.0 cm (0.2" - 12.2")
Datamatrix	10 mil: 5.5- 27.0 cm (2.2" - 10.6") 15 mil: 2.8 - 41.0 cm (1.1" - 16.1")	5 mil: 5.5 - 9.0 cm (2.2" - 3.5") 10 mil: 0.2 - 27.0 cm (0.1" - 10.6")
Max Resolution	1D Min = 4 mils PDF417 Min = 5 mils Datamatrix Min = 7.5 mils	1D Min = 3 mils PDF417 Min = 3 mils Datamatrix Min = 4 mils

<sup>a</sup>. 13 mils DOF based on EAN. All other 1D codes are Code 39. All labels grade A, typical environmental light, 20°C, label inclination 10°

Environmental Features	
Operating Temperature	0 °C to + 50 °C (+32° F to +122 °F)
Storage Temperature	-40 °C to + 70 °C (-40 ° F to +158 °F)
Humidity	95% non condensing
Drop Resistance	IEC 68-2-32 Tested 1.8 m (6 ft)
ESD Protection	16 KV
Protection Class	IP52
Weight (without cable)	GD4500 approx. 161 g (5.7 oz.) GD4500 with integrated stand approx. 374 g (13.2 oz.) GBT/GM4500: Approx. 235 g (8.29 oz.) GBT4500 or GM4500 and battery pack included Battery Pack is approx. 65 g (2.29 oz.)
Cable Length	Refer to <a href="http://www.datalogic.com">www.datalogic.com</a>

Decode Capability
<p><b>1D Bar Codes</b></p> <p>UPC/EAN/JAN (A, E, 13, 8); UPC/EAN/JAN (including P2 /P5); UPC/EAN/JAN (including; ISBN / Bookland &amp; ISSN); UPC/EAN Coupons; Code 39 (including full ASCII); Code 39 Trioptic; Code39 CIP (French Pharmaceutical); LOGMARS (Code 39 w/ standard check digit enabled); Danish PPT; Code 32 (Italian Pharmacode 39); Code 128; Code 128 ISBT; Interleaved 2 of 5; Standard 2 of 5; Interleaved 2 of 5 CIP (HR); Industrial 2 of 5; Discrete 2 of 5; Matrix 2 of 5; IATA 2of5 Air cargo code; Code 11; Codabar; Codabar (NW7); ABC Codabar; EAN 128; Code 93 ; MSI; PZN; Plessey; Anker Plessey; GS1 DataBar Omnidirectional; GS1 DataBar Limited; GS1 DataBar Expanded; GS1 DataBar Truncated; DATABAR Expanded Coupon.</p>
<p><b>2D / Stacked Codes</b></p> <p>The Gryphon I GD4500 scanner is capable of decoding the following symbologies using multiple frames (i.e. Multi-Frame Decoding):</p> <p>Datamatrix; Inverse Datamatrix; Datamatrix is configurable for the following parameters; Normal or Inverted; Square or Rectangular Style; Data length (1 - 3600 characters); Maxicode; QR Codes (QR, Micro QR and Multiple QR Codes); Aztec; Postal Codes - (Australian Post; Japanese Post; KIX Post; Planet Code; Postnet; Royal Mail Code (RM45CC); Intelligent Mail Barcode (IMB); Sweden Post; Portugal Post); LaPoste A/R 39; PDF-417; MacroPDF; Micro PDF417; GS1 Composites (1 - 12); French CIP13<sup>a</sup>; GS1 DataBar Stacked; GS1 DataBar Stacked Omnidirectional; GS1 DataBar Expanded Stacked; GS1 Databar Composites; Chinese Sensible Code; Inverted 2D codes<sup>b</sup>.</p> <p><sup>a</sup>It is acceptable to handle this with ULE</p> <p><sup>b</sup>The SW can apply the Normal/Reverse Decoding Control to the following symbologies: Datamatrix, QR, Micro QR, Aztec and Chinese Sensible Code.</p>



Regulatory			
See Regulatory Addendum			

Radio Features			
Wireless Technology	Star™ 910 MHz	Star™ 433 MHz	Bluetooth
Range (in open air)	50 m	50 m	100 m
Max number of devices per base station	16		7

## LED and Beeper Indications

The imager’s beeper sounds and its illumination flashes or changes color to indicate various functions or errors on the reader. A “Green Spot” also lights to indicate a good read. The tables below list these indications.

**Table 28. LED and Speaker Indications**

Indication	LED	Beeper
Power-up	Upper LED flashes/blinks on power-up, however, this may be too rapid to view. With a USB interface, the LED blinks until enumeration with the host is completed.	Imager beeps four times at highest frequency and volume upon power-up.
Good Read	Upper green LED comes on for programmed time (default). LED behavior for this indication is configurable using Aladdin utility.	One beep at current frequency, volume, mono/bi-tonal setting upon a successful label scan.
ROM Failure	200ms on / 200ms off	Imager sounds one error beep at highest volume for 200 mS.
Limited Scanning Label Read	N/A	Imager 'chirps' six times at the highest frequency and current volume.
Imager Disabled	The LED blinks continuously 100mS on / 900 mS off	N/A

## User Indications for GD4500

Indication	3GL & Good Read LEDs	Buzzer
Power-up	OFF	Rising Beeps' Sequence
USB Enumeration Phase	250 ms <sup>a</sup> ON ↔ 250 ms OFF	OFF
USB Suspend	Depends on Power Cable and specific configurations	OFF
Idle	OFF	OFF
While Reading	OFF	OFF
Decode Done	Solid ON Programmable duration (1 s default)	Single Beep
Reader Disabled (POS) Communication with host not established	100 ms ON ↔ 900 ms OFF	OFF
Firmware Upgrade	250 ms ON ↔ 250 ms OFF	OFF
Host Download	250 ms ON ↔ 250 ms OFF	OFF
Enter Service Mode	No Effect	Beeps' Sequence
Label Programming	No Effect	Beep

<sup>a</sup> 'ms' stands for milliseconds, equivalent to 1/1000<sup>th</sup> of a second

## User Indications GBT/GM4500 (Gun Only)

Status	3GL & Good Read LEDs	Battery LED	Buzzer
Power-Up	OFF	OFF	Rising Beeps' Sequence
USB Enumeration Phase	250 ms <sup>a</sup> ON ↔ 250 ms OFF	OFF	OFF
USB Suspend	Depends on Power Cable and specific configurations	OFF	OFF
Idle	OFF	OFF	OFF
While Reading	OFF	OFF	OFF
Decode Done	Solid ON with programmable duration (1 s default)	OFF	Single Beep
Reader Disabled (POS) Communication with host not established	100 ms ON ↔ 900 ms OFF	OFF	OFF
Firmware Upgrade	250 ms ON ↔ 250 ms OFF	OFF	OFF
Host Download	250 ms ON ↔ 250 ms OFF	OFF	OFF
Paging Answer	5 cycles: 100 ms ON ↔ 900 ms OFF	OFF	5 Beeps (when LED ON)
Enter Service Mode	No Effect	OFF	Beeps' Sequence
Label Programming	No Effect	OFF	Beep
ACK Received on Transmission	OFF	OFF	Single Programmable Beep (OFF by default)
ACK NOT Received on Transmission	OFF	OFF	Wrong Beep
Cradle in USB Suspend	Depends on Power Cable and specific configurations	OFF	OFF
Configuration Alignment	250 ms ON ↔ 250 ms OFF	OFF	OFF

<sup>a</sup> "ms" stands for milliseconds, equivalent to 1/1000th of a second

Status	3GL & Good Read LEDs	Battery LED	Buzzer
Charge in Progress through microUSB	OFF	Fading: 1 s ON ↔ 1 s OFF Green (charge = 50% - 99%) Amber (charge = 1% - 49%) Red (charge less than 1%) Scanner is unusable until 1% is reached	OFF
Charge Complete through microUSB	OFF	Solid Green It goes OFF when unplugged	OFF
Charge Fault	OFF	OFF	OFF
Charge in Progress through CRADLE	OFF	OFF	OFF
Charge Complete through CRADLE	OFF	OFF	OFF
Battery Status	OFF	Solid with programmable duration (3 s default) and then OFF Green (charge = 50% - 100%) Amber (charge = 2% - 50%) Red forced loop (charge less than 2%)	OFF

## User Indications GBT/GM4500 (Cradle Only)

Status	Transmission LEDs	Charging LEDs
Power-Up	Solid ON	OFF
USB Enumeration	250 ms <sup>a</sup> ON ↔ 250 ms OFF	OFF
USB Suspend	Depends on Power Cable and specific configurations	OFF
Idle	Solid ON	OFF
While Reading	Solid ON	OFF
Label Transmitted to HOST	OFF for 100 ms and then Solid ON	OFF
Reader Disabled (POS) Communication with host not established	100 ms ON ↔ 900 ms OFF	OFF
Firmware Upgrade	250 ms ON ↔ 250 ms OFF	OFF
Host Download	250 ms ON ↔ 250 ms OFF	OFF
Configuration Alignment	250 ms ON ↔ 250 ms OFF	OFF
Enter Service Mode	No Effect (remains Solid ON)	OFF
Short button press (1-5 s) Paging request	Blink Green 500 ms ON ↔ 500 ms OFF (for 5 s while pressing button)	OFF
Long button press (6-10 s) Flush Piconet request	Blink Green 1 s ON - 1 s OFF (for 5 s while pressing button)	OFF
Charge in Progress	No effect	Fading: 1 s ON ↔ 1 s OFF Green (charge = 50% - 99%) Amber (charge = 0% - 49%)
Charge Complete	No effect	Solid Green It goes OFF when unplugged
Charge Fault	No effect	OFF
Electrical Fault	OFF	OFF

<sup>a</sup> “ms” stands for milliseconds, equivalent to 1/1000th of a second

## Programming Mode

The following indications ONLY occur when the scanner is in Programming Mode.

INDICATION	DESCRIPTION	LED	SPEAKER
Label Programming Mode Entry	A valid programming label has been scanned.	LED blinks continuously	Scanner sounds four low frequency beeps.
Label Programming Mode Rejection of Label	A label has been rejected.	N/A	Scanner sounds three times at lowest frequency & current volume.
Label Programming Mode Acceptance of Partial Label	In cases where multiple labels must be scanned to program one feature, this indication acknowledges each portion as it is successfully scanned.	N/A	Scanner sounds one short beep at highest frequency & current volume.
Label Programming Mode Acceptance of Programming	Configuration option(s) have been successfully programmed via labels and the scanner has exited Programming Mode.	N/A	Scanner sounds one high frequency beep and 4 low frequency beeps followed by reset beeps.
Label Programming Mode Cancel Item Entry	Cancel label has been scanned.	N/A	Scanner sounds two times at low frequency and current volume.

## Troubleshooting

Problem	Possible Cause	Possible Solutions
Nothing happens when the scan button is pulled.	No power to the imager.	Check system power. Ensure power supply is connected.
	Interface or power cables are loose.	Ensure all cable connections are secure.
LED comes on, but bar code does not decode.	Imager not programmed for correct bar code type.	Ensure imager is programmed to read the type of bar code scanned. Refer to the PRG for more information.
	Bar code label is unreadable.	Check the label to ensure it is not defaced. Try scanning another bar code type.
	Distance between imager and bar code is incorrect.	Move imager closer to or further from the bar code.
Bar code is decoded but not transmitted to the host.	Imager not programmed for the correct host type.	Scan the appropriate host type bar code. Refer to the PRG for more information.

## Standard Cable Pinouts

Figure 22 and Table 29 provide standard pinout information for the scanner's cable.

**Figure 22. Standard Cable Pinouts**

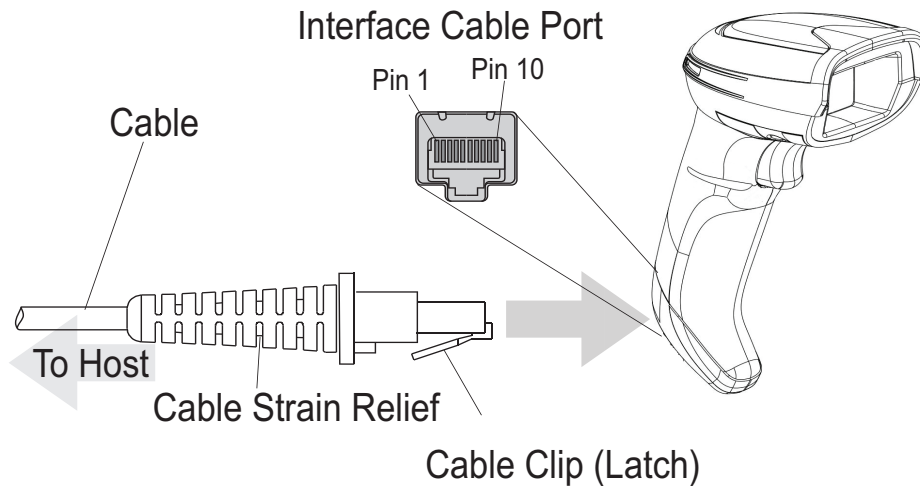

The signal descriptions in Table 29 apply to the connector on the scanner and are for reference only.

**Table 29. Standard Cable Pinouts — Scanner Side**

Pin	RS-232	USB	Keyboard Wedge
1	RTS (out)		
2		D+	CLKIN (KBD side)
3		D-	DATAIN (KBD side)
4	GND	GND	GND
5	RX		
6	TX		
7	VCC	VCC	VCC
8			CLKOUT (PC side)
9			DATAOUT (PC side)
10	CTS (in)		

# NOTES





## Appendix B Standard Defaults

The most common configuration settings are listed in the “Default” column of the table below. Page references are also provided for feature descriptions and programming bar codes for each parameter. A column has also been provided for recording of your preferred default settings for these same configurable features.

**Table 30. Standard Defaults**

Parameter	Default	Your Setting	Page Number
<b>GLOBAL INTERFACE FEATURES</b>			
Host Commands — Obey/Ignore	Obey		39
USB Suspend Mode	Enable		39
<b>RS-232 ONLY</b>			
Baud Rate	9600		41
Data Bits	8 Data Bits		42
Stop Bits	1 Stop Bit		43
Parity	None		43
Handshaking Control	RTS		44
<b>RS-232/USB-COM</b>			
Intercharacter Delay	No Delay		46
Beep On ASCII BEL	Disable		47
Beep On Not on File	Enable		47
ACK NAK Options	Disable		48
ACK Character	'ACK'		49
NAK Character	'NAK'		49
ACK NAK Timeout Value	200 ms		50
ACK NAK Retry Count	3 Retries		51
ACK NAK Error Handling	Ignore Errors Detected		52
Indicate Transmission Failure	Enable		53

Parameter	Default	Your Setting	Page Number
Disable Character	'D'		53
Enable Character	'E'		54
<b>KEYBOARD WEDGE</b>			
Country Mode	U.S. Keyboard		56
Keyboard Send Control Characters	00		81
Wedge Quiet Interval	100 ms		82
Intercode Delay	No Delay		84
Caps Lock State	Caps Lock OFF		79
Numlock	NumLock Key Unchanged		79
USB Keyboard Speed	1 ms		85
Keyboard Numeric Keypad	Standard Keys		80
<b>USB-OEM</b>			
USB-OEM Device Usage	Handheld		88
USB-OEM Interface Options	Ignore Scanner Configuration Host Commands		88
<b>DATA FORMAT</b>			
Global Prefix/Suffix	No Global Prefix Global Suffix = 0x0D (CR)		76
Global AIM ID	Disable		77
GS1-128 AIM ID	Enable		77
Label ID: Pre-loaded Sets	EU Set		78
Label ID: Pre-loaded Sets	Disable		78
Case Conversion	Disable		85
Character Conversion	No Char Conversion		86
<b>READING PARAMETERS</b>			
Double Read Timeout	0.6 Second		106
Power On Alert	Power-up Beep		109
Good Read: When to Indicate	After Decode		110
Good Read Beep Type	Mono		111
Good Read Beep Frequency	High		111

Parameter	Default	Your Setting	Page Number
Good Read Beep Length	80 ms		113
Good Read Speaker Volume	High		112
Enable/Disable Good Read Indicator	300 ms		114
<b>SCANNING FEATURES</b>			
Scan Mode	Trigger Single		115
Stand Mode Sensitivity	Medium		120
Stand Mode Indication	5 Seconds		118
Flash On Time	OFF		116
Flash On Time	10 = Flash is ON for 1 Second		116
Flash Off Time	06 = Flash is OFF for 600ms		117
<b>CODE SELECTION - 1D SYMBOLOGIES</b>			
Code EAN/UPC			
Coupon Control	Enable only UPCA coupon decoding		114
<b>UPC-A</b>			
UPC-A Enable/Disable	Enable		135
UPC-A Check Character Transmission	Send		135
Expand UPC-A to EAN-13	Don't Expand		136
UPC-A Number System Character Transmission	Transmit		136
<b>UPC-E</b>			
UPC-E Enable/Disable	Enable		138
UPC-E Check Character Transmission	Send		138
Expand UPC-E to EAN-13	Don't Expand		139
Expand UPC-E to UPC-A	Don't Expand		139
UPC-E Number System Character Transmission	Transmit		139
<b>GTIN</b>			
EAN 13	Disable		140

Parameter	Default	Your Setting	Page Number
<b>EAN 13 (Jan 13)</b>			
EAN 13 Enable/Disable	Enable		140
EAN 13 Check Character Transmission	Send		140
EAN-13 Flag 1 Character	Transmit		141
EAN-13 ISBN Conversion	Disable		141
<b>ISSN</b>	Disable		142
<b>EAN 8</b>			
EAN 8 Enable/Disable	Enable		143
EAN 8 Check Character Transmission	Send		143
Expand EAN 8 to EAN 13	Disable		144
<b>UPC/EAN Global Settings</b>			
UPC/EAN Price Weight Check	Disable		145
<b>Add-Ons</b>			
Optional Add-ons	Disable P2, P5 and P8		146
Optional Add-On Timer	70 ms		147
<b>Code 39</b>			
Code 39 Enable/Disable	Enable		154
Code 39 Check Character Calculation	Disable		154
Code 39 Check Character Transmission	Send		155
Code 39 Start/Stop Character Transmission	Don't Transmit		156
Code 39 Full ASCII	Disable		156
Code 39 Quiet Zones	Small Quiet Zones on two sides		157
Code 39 Length Control	Variable		158
Code 39 Set Length 1	2		159
Code 39 Set Length 2	50		160
<b>Code 32 (Italian Pharmaceutical Code)</b>			
Code 32 Enable/Disable	Disable		161
Code 32 Check Character Transmission	Don't Send		161

Parameter	Default	Your Setting	Page Number
Code 32 Start/Stop Character Transmission	Don't Transmit		162
<b>Code 39 CIP (French Pharmaceutical Code)</b>			
Code 39 CIP Enable/Disable	Disable		162
<b>Special Codes</b>			
<b>Code 128</b>			
Code 128 Enable/Disable	Enable		163
Expand Code 128 to Code 39	Don't Expand		163
Code 128 Check Character Transmission	Don't Send		164
Code 128 Function Character Transmission	Don't Send		164
Code 128 Quiet Zones	Small Quiet Zones on two sides		165
Code 128 Length Control	Variable		166
Code 128 Set Length 1	1		166
Code 128 Set Length 2	80		167
<b>GS1-128</b>			
GS1-128 Enable	Transmit in Code 128 Data Format		168
<b>ISBT 128</b>			
ISBT 128 Concatenation	Disable		199
ISBT 128 Force Concatenation	Disable		201
ISBT 128 Concatenation Mode	Static		199
ISBT 128 Dynamic Concatenation Timeout	200 msec		200
<b>Interleaved 2 of 5</b>			
I 2 of 5 Enable/Disable	Disable		169
I 2 of 5 Check Character Calculation	Disable		170
I 2 of 5 Check Character Transmission	Send		171
I 2 of 5 Length Control	Variable		171
I 2 of 5 Set Length 1	6		172
I 2 of 5 Set Length 2	50		173

Standard Defaults

Parameter	Default	Your Setting	Page Number
<b>Interleaved 2 of 5 CIP HR</b>			
Interleaved 2 of 5 CIP HR Enable/Disable	Disable		174
<b>Follett 2 of 5</b>			
Follett 2 of 5 Enable/Disable	Disable		211
<b>Standard 2 of 5</b>			
Standard 2 of 5 Enable/Disable	Disable		190
Standard 2 of 5 Check Character Calculation	Disable		190
Standard 2 of 5 Check Character Transmission	Send		191
Standard 2 of 5 Length Control	Variable		191
Standard 2 of 5 Length Control	8		191
Standard 2 of 5 Set Length 2	50		193
<b>Industrial 2 of 5</b>			
Industrial 2 of 5 Enable/Disable	Disable		194
Industrial 2 of 5 Check Character Calculation	Disable		194
Industrial 2 of 5 Check Character Transmission	Enable		195
Industrial 2 of 5 Length Control	Variable		195
Industrial 2 of 5 Set Length 1	1		196
Industrial 2 of 5 Set Length 2	50		197
<b>Code IATA</b>			
IATA Enable/Disable	Disable		198
IATA Check Character Transmission	Enable		198

Parameter	Default	Your Setting	Page Number
<b>Codabar</b>			
Codabar Enable/Disable	Disable		178
Codabar Check Character Calculation	Don't Calculate		178
Codabar Check Character Transmission	Send		179
Codabar Start/Stop Character Transmission	Transmit		179
Codabar Start/Stop Character Set	abcd/abcd		180
Codabar Start/Stop Character Match	Don't Require Match		180
Codabar Quiet Zones	Small Quiet Zones on two sides		181
Codabar Length Control	Variable		182
Codabar Set Length 1	3		182
Codabar Set Length 2	50		183
<b>ABC Codabar</b>			
ABC Codabar Enable/Disable	Disable		184
ABC Codabar Concatenation Mode	Static		184
ABC Codabar Dynamic Concatenation Timeout	200 msec		185
ABC Codabar Force Concatenation	Disable		185
<b>Code 11</b>			
Code 11 Enable/Disable	Disable		186
Code 11 Check Character Calculation	Check C and K		186
Code 11 Check Character Transmission	Send		187
Code 11 Length Control	Variable		187
Code 11 Set Length 1	4		188
Code 11 Set Length 2	50		189
<b>GS1 DataBar Omnidirectional</b>			
GS1 DataBar Omnidirectional Enable/Disable	Disable		148
GS1 DataBar Omnidirectional GS1-128 Emulation	Disable		148

Parameter	Default	Your Setting	Page Number
<b>GS1 DataBar™ Expanded</b>			
GS1 DataBar Expanded Enable/Disable	Disable		150
GS1 DataBar Expanded GS1-128 Emulation	Disable		150
	2D component not required		150
GS1 DataBar Expanded Length Control	Variable		151
GS1 DataBar Expanded Set Length 1	1		151
GS1 DataBar Expanded Set Length 2	74		152
<b>GS1 DataBar™ Limited</b>			
GS1 DataBar Limited Enable/Disable	Disable		153
GS1 DataBar Limited GS1-128 Emulation	Disable		153
<b>Code 93</b>			
Code 93 Enable/Disable	Disable		206
Code 93 Check Character Calculation	Enable Check C and K		206
Code 93 Check Character Transmission	Disable		207
Code 93 Length Control	Variable		207
Code 93 Set Length 1	1		208
Code 93 Set Length 2	50		209
Code 93 Quiet Zones	Small Quiet Zones on two sides		210
<b>MSI</b>			
MSI Enable/Disable	Disable		202
MSI Check Character Calculation	Enable Mod10		202
MSI Check Character Transmission	Enable		203
MSI Length Control	Variable		203
MSI Set Length 1	1		204
MSI Set Length 2	50		205
<b>MOTION FEATURES</b>			



Parameter	Default	Your Setting	Page Number
Motion Aiming Control	Enable		231
Motion Sensitivity	Medium		232
Motionless Timeout	2 seconds		233

## Default Exceptions

Table 31. Default Exceptions by Interface Type

Parameter	Default Exception
<b>Interfaces: USB-OEM</b>	
Global Suffix	No Global Suffix
Double Read Timeout	500 msec
<b>Interfaces: All Keyboard Wedge, USB Keyboard</b>	
No unique settings	
<b>Interface: RS232-WN</b>	
Expand UPC-A to EAN-13	Enable
UPC-E Check Character Transmission	Disable
Parity	Odd Parity
Handshaking Control	RTS/CTS
Transmission Label ID Code	Prefix
GS1-128 AIM ID	Disable
UPCE Label ID Character(s)	C
EAN 8 Label ID Character(s)	B
EAN 13 Label ID Character(s)	A
Code ISBN Label ID Character(s)	A
Code 39 Label ID Character(s)	M
Interleaved 2of5 Label ID Character(s)	I
Code Standard 2/5 Label ID Character(s)	H
Codabar Label ID Character(s)	N
Code 128 Label ID Character(s)	K

## Standard Defaults

Parameter	Default Exception
GS1-128 Label ID Character(s)	P
Datalogic 2 of 5 Label ID Character(s)	H
ISBT 128 Label ID Character(s)	K
UPCE P2 Label ID Character(s)	C
UPCE/P5 Label ID Character(s)	C
UPCE/GS1-128 Label ID Character(s)	C
EAN8/P2 Label ID Character(s)	B
EAN8/P5 Label ID Character(s)	B
EAN8/GS1-128 Label ID Character(s)	B
EAN13/P2 Label ID Character(s)	A
EAN13/P5 Label ID Character(s)	A
EAN13/GS1-128 Label ID Character(s)	A
GS1 DataBar 14 (Omnidirectional) Label ID Character(s)	E
GS1 DataBar Expanded Label ID Character(s)	E
GS1 DataBar Limited Label ID Character(s)	E
Character Conversion	CR to `
<b>Interface: RS232-OPOS</b>	
Baud Rate	115200 Baud
Transmission Label ID Code	Prefix
GS1-128 AIM ID	Disable
UPCA Label ID Character(s)	C
UPCE Label ID Character(s)	D
EAN 8 Label ID Character(s)	A
EAN 13 Label ID Character(s)	B
Code ISBN Label ID Character(s)	@
Code 39 Label ID Character(s)	V
Code 32 Label ID Character(s)	X
Interleaved 2of5 Label ID Character(s)	N
Code Standard 2/5 Label ID Character(s)	P

<b>Parameter</b>	<b>Default Exception</b>
Codabar Label ID Character(s)	R
Code 11 Label ID Character(s)	b
Code 128 Label ID Character(s)	T
GS1-128 Label ID Character(s)	k
UPCA/P2 Label ID Character(s)	F
UPCA/P5 Label ID Character(s)	G
UPCA/GS1-128 Label ID Character(s)	Q
UPCE P2 Label ID Character(s)	H
UPCE/P5 Label ID Character(s)	I
EAN8/P2 Label ID Character(s)	J
EAN8/P5 Label ID Character(s)	K
EAN8/GS1-128 Label ID Character(s)	*
EAN13/P2 Label ID Character(s)	L
EAN13/P5 Label ID Character(s)	M
EAN13/GS1-128 Label ID Character(s)	#
GS1 DataBar 14 (Omnidirectional) Label ID Character(s)	u
GS1 DataBar Expanded Label ID Character(s)	t
GS1 DataBar Limited Label ID Character(s)	v

# NOTES



# Appendix C

## Sample Bar Codes

The sample bar codes in this appendix are typical representations for their symbology types.

### 1D Bar Codes



978033029095



Code 128



## Sample Bar Codes (continued)

Code 32

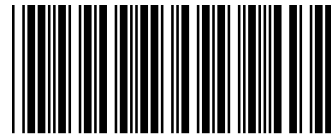

B9P91Q

Codabar

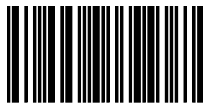

13579

Code 93



ABCDEF

Code 11



123456789

## GS1 DataBar™ (RSS)



GS1 DataBar™ variants must be enabled to read the bar codes below (see "GS1 DataBar™ Omnidirectional" on page 148).

**GS1 DataBar™ Expanded Stacked**



10293847560192837465019283746029478450366523

**GS1 DataBar™ Expanded**



1234890hjo9900mnb

**GS1 DataBar™ Limited**



08672345650916

## GS1 DataBar™-14

**GS1 DataBar™ Omnidirectional Truncated**



55432198673467

**GS1 DataBar™ Omnidirectional Stacked**



90876523412674

**GS1 DataBar™ Omnidirectional Stacked**



78123465709811

## 2D Bar Codes

Aztec



Datamatrix



China Sensible Code



MaxiCode

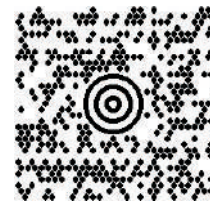

*Test Message*

PDF 417



ABCabc

Micro PDF 417



BV17453

QR Code

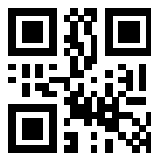

35900G9

Micro QR Code



123456

UCC Composite

(17) 050923 (10) ABC123



(01) 0 4012345 67890 1 1





# Appendix D

## Keypad

Use the bar codes in this appendix to enter numbers as you would select digits/characters from a keypad.



0



1

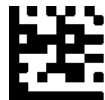

2



3



4



5



6



7



8



9

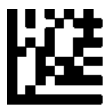

A

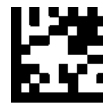

B



C



D



E



F



# Appendix E

## Scancode Tables

### Control Character Emulation

Control character emulation selects from different scancode tables as listed in this appendix. Each of the control character sets below are detailed by interface type in the tables. These apply to Wedge and USB Keyboard platforms.

**Control Character 00**: Characters from 00 to 0x1F are sent as control character Ctrl+Keys, special keys are located from 0x80 to 0xA1.

**Control Character 01**: Characters from 00 to 0x1F are sent as control character Ctrl+Capital Key, special keys are located from 0x80 to 0xA1.

**Control Character 02**: Special keys are located from 00 to 0x1F and characters from 0x80 to 0xFE are intended as an extended ASCII table (Microsoft Windows Codepage 1252 — see [page 342](#)).

### Single Press and Release Keys

In the following tables, Ar↓ means Alt right pressed and Ar↑ means Alt right released and so on. Definitions for other keys are Al (Alt left ), Cr (Control Right ) Cl (Control Left ) Sh (shift). This method can be used for combining Alt, Control or Shift with other keys.

Example: Consider a Control character set to 00. If AltRight+A is required before sending a label to the host, it could be done by setting three Prefix keys in this way: 0x99 0x41 0x9A.

# Interface Type PC AT PS/2 or USB-Keybaord

Table 32. Scancode Set When Control Character is 00 or 01

	x0	x1	x2	x3	x4	x5	X6	x7	x8	x9	xA	xB	xC	xD	xE	xF
0x	NULL C+@	SOH C(S)+A	STX C(S)+B	ETX C(S)+C	EOT C(S)+D	ENQ C(S)+E	ACK C(S)+F	BEL C(S)+G	BS	HT TAB	LF C(S)+J	VT C(S)+K	FF C(S)+L	CR Enter	SO C(S)+N	SI C(S)+O
1x	DLE C(S)+P	DC1 C(S)+Q	DC2 C(S)+R	DC3 C(S)+S	DC4 C(S)+T	NAK C(S)+U	SYN C(S)+V	ETB C(S)+W	CAN C(S)+X	EM C(S)+Y	SUB C(S)+Z	ESC Esc	FS C+\ C+]	GS C+]	RS C+^	US C(S)+_
2x	SP	!	"	#	\$	%	&	'	(	)	*	+	,	-	.	/
3x	0	1	2	3	4	5	6	7	8	9	:	;	<	=	>	?
4x	@	A	B	C	D	E	F	G	H	I	J	K	L	M	N	O
5x	P	Q	R	S	T	U	V	W	X	Y	Z	[	\	]	^	_
6x	`	a	b	c	d	e	f	g	h	i	j	k	l	m	n	o
7x	p	q	r	s	t	u	v	w	x	y	z	{		}	~	Del
8x	€	Sh↓	Sh↑	Ins	Ent (keyp)	F1	F2	F3	F4	F5	F6	F7	F8	F9	F10	F11
9x	F12	Home	End	Pg Up	Pg Dwn	↑	↓	←	→	Ar↓	Ar↑	Al↓	Al↑	Cl↓	Cl↑	Cr↓
Ax	Cr↑		‘	f	„	…	†	‡	^	‰	Š	◀	Š	◀	Œ	
Bx	°	±	²	³	´	µ	¶	·	,	‘	°	»	¼	½	¾	¿
Cx	À	Á	Â	Ã	Ä	Å	Æ	Ç	È	É	Ê	Ë	Ì	Í	Î	Ï
Dx	Ð		Ò	Ó	Ô	Õ	Ö	×	Ø	Ù	Ú	Û	Ü	Ý	Þ	ß
Ex	à	á	â	ã	ä	å	æ	ç	è	é	ê	ë	ì	í	î	ï
Fx	ð	ñ	ò	ó	ô	õ	ö	÷	ø	ù	ú	û	ü	ý	þ	ÿ

Extended characters (sky blue) are sent through dedicated keys (when available in the selected country mode) or by using an Alt Mode sequence.

## Interface Type PC AT PS/2 or USB-Keybaord (continued)

Table 33. Scancode Set When Control Character is 02

	x0	x1	x2	x3	x4	x5	X6	x7	x8	x9	xA	xB	xC	xD	xE	xF
0x	Ar↓	Ar↑	Al↓	Al↑	Cl↓	Cl↑	Cr↓	Cr↑	BS	Tab	→	S+ Tab	Enter Keyprd	Enter	Ins	Pg Up
1x	Pg Dwn	Home	←	↓	↑	F6	F1	F2	F3	F4	F5	ESC	F7	F8	F9	F10
2x	Space	!	“	#	\$	%	&	‘	(	)	*	+	,	-	.	/
3x	0	1	2	3	4	5	6	7	8	9	:	;	<	=	>	?
4x	@	A	B	C	D	E	F	G	H	I	J	K	L	M	N	O
5x	P	Q	R	S	T	U	V	W	X	Y	Z	[	\	]	^	_
6x	`	a	b	c	d	e	f	g	h	i	j	k	l	m	n	o
7x	p	q	r	s	t	u	v	w	x	y	z	{		}	~	Del
8x	€	‘	ƒ	„	…	†	‡	^	‰	Š	<	Š	<	Œ		
9x		‘	’	“	”	•	–	—	~	™	š	>	œ		ž	ÿ
Ax	NBSP	ı	¢	£	¤	¥	¦	§	¨	©	ª	«	¬	-	®	¯
Bx	°	±	²	³	´	µ	¶	·	,	ı	°	»	¼	½	¾	¿
Cx	À	Á	Â	Ã	Ä	Å	Æ	Ç	È	É	Ê	Ë	Ì	Í	Î	Ï
Dx	Ð		Ò	Ó	Ô	Õ	Ö	×	Ø	Ù	Ú	Û	Ü	Ý	Þ	ß
Ex	à	á	â	ã	ä	å	æ	ç	è	é	ê	ë	ì	í	î	ï
Fx	ð	ñ	ò	ó	ô	õ	ö	÷	ø	ù	ú	û	ü	ý	þ	ÿ

# Interface Type PC AT PS/2 Alt Mode or USB-Keyboard Alt Mode

Table 34. Scancode Set When Control Character is 00 or 01

	x0	x1	x2	x3	x4	x5	X6	x7	x8	x9	xA	xB	xC	xD	xE	Xf
0x	Alt+000	Alt+001	Alt+002	Alt+003	Alt+004	Alt+005	Alt+006	Alt+007	BS	HT TAB	Alt+010	Alt+011	Alt+012	CR Enter	Alt+014	Alt+015
1x	Alt+016	Alt+017	Alt+018	Alt+019	Alt+020	Alt+021	Alt+022	Alt+023	Alt+024	Alt+025	Alt+026	ESC Esc	Alt+028	Alt+029	Alt+030	Alt+031
2x	A+032	A+033	A+034	A+035	A+036	A+037	A+038	A+039	A+040	A+041	A+042	A+043	A+044	A+045	A+046	A+047
3x	A+048	A+049	A+050	A+051	A+052	A+053	A+054	A+055	A+056	A+057	A+058	A+059	A+060	A+061	A+062	A+063
4x	A+064	A+065	A+066	A+067	A+068	A+069	A+070	A+071	A+072	A+073	A+074	A+075	A+076	A+077	A+078	A+079
5x	A+080	A+081	A+082	A+083	A+084	A+085	A+086	A+087	A+088	A+089	A+090	A+091	A+092	A+093	A+094	A+095
6x	A+096	A+097	A+098	A+099	A+100	A+101	A+102	A+103	A+104	A+105	A+106	A+107	A+108	A+109	A+110	A+111
7x	A+112	A+113	A+114	A+115	A+116	A+117	A+118	A+119	A+120	A+121	A+122	A+123	A+124	A+125	A+126	A+127
8x	€	Sh↓	Sh↑	Ins	Ent (keyp)	F1	F2	F3	F4	F5	F6	F7	F8	F9	F10	F11
9x	F12	Home	End	Pg Up	Pg Dwn	↑	↓	←	→	Ar↓	Ar↑	Al↓	Al↑	Cl↓	Cl↑	Cr↓
Ax	Cr↑	A+0161	A+0162	A+0163	A+0164	A+0165	A+0166	A+0167	A+0168	A+0169	A+0170	A+0171	A+0172	A+0173	A+0174	A+0175
Bx	A+0176	A+0177	A+0178	A+0179	A+0180	A+0181	A+0182	A+0183	A+0184	A+0185	A+0186	A+0187	A+0188	A+0189	A+0190	A+0191
Cx	A+0192	A+0193	A+0194	A+0195	A+0196	A+0197	A+0198	A+0199	A+0200	A+0201	A+0202	A+0203	A+0204	A+0205	A+0206	A+0207
Dx	A+0208	A+0209	A+0210	A+0211	A+0212	A+0213	A+0214	A+0215	A+0216	A+0217	A+0218	A+0219	A+0220	A+0221	A+0222	A+0223
Ex	A+0224	A+0225	A+0226	A+0227	A+0228	A+0229	A+0230	A+0231	A+0232	A+0233	A+0234	A+0235	A+0236	A+0237	A+0238	A+0239
Fx	A+0240	A+0241	A+0242	A+0243	A+0244	A+0245	A+0246	A+0247	A+0248	A+0249	A+0250	A+0251	A+052	A+0253	A+0254	A+0255

## Interface Type PC AT PS/2 Alt Mode or USB-Keyboard Alt Mode (continued)

Table 35. Scancode Set When Control Character is 02

	x0	x1	x2	x3	x4	x5	X6	x7	x8	x9	xA	xB	xC	xD	xE	xF
0x	Ar↓	Ar↑	Al↓	Al↑	Cl↓	Cl↑	Cr↓	Cr↑	BS	Tab	→	S+ Tab	Enter Keyprd	Enter	Ins	Pg Up
1x	Pg Dwn	Home	←	↓	↑	F6	F1	F2	F3	F4	F5	ESC	F7	F8	F9	F10
2x	A+032	A+033	A+034	A+035	A+036	A+037	A+038	A+039	A+040	A+041	A+042	A+043	A+044	A+045	A+046	A+047
3x	A+048	A+049	A+050	A+051	A+052	A+053	A+054	A+055	A+056	A+057	A+058	A+059	A+060	A+061	A+062	A+063
4x	A+064	A+065	A+066	A+067	A+068	A+069	A+070	A+071	A+072	A+073	A+074	A+075	A+076	A+077	A+078	A+079
5x	A+080	A+081	A+082	A+083	A+084	A+085	A+086	A+087	A+088	A+089	A+090	A+091	A+092	A+093	A+094	A+095
6x	A+096	A+097	A+098	A+099	A+100	A+101	A+102	A+103	A+104	A+105	A+106	A+107	A+108	A+109	A+110	A+111
7x	A+112	A+113	A+114	A+115	A+116	A+117	A+118	A+119	A+120	A+121	A+122	A+123	A+124	A+125	A+126	A+127
8x	A+0128	A+0129	A+0130	A+0131	A+0132	A+0133	A+0134	A+0135	A+0136	A+0137	A+0138	A+0139	A+0140	A+0141	A+0142	A+0143
9x	A+0144	A+0145	A+0146	A+0147	A+0148	A+0149	A+0150	A+0151	A+0152	A+0153	A+0154	A+0155	A+0156	A+0157	A+0158	A+0159
Ax	A+0160	A+0161	A+0162	A+0163	A+0164	A+0165	A+0166	A+0167	A+0168	A+0169	A+0170	A+0171	A+0172	A+0173	A+0174	A+0175
Bx	A+0176	A+0177	A+0178	A+0179	A+0180	A+0181	A+0182	A+0183	A+0184	A+0185	A+0186	A+0187	A+0188	A+0189	A+0190	A+0191
Cx	A+0192	A+0193	A+0194	A+0195	A+0196	A+0197	A+0198	A+0199	A+0200	A+0201	A+0202	A+0203	A+0204	A+0205	A+0206	A+0207
Dx	A+0208	A+0209	A+0210	A+0211	A+0212	A+0213	A+0214	A+0215	A+0216	A+0217	A+0218	A+0219	A+0220	A+0221	A+0222	A+0223
Ex	A+0224	A+0225	A+0226	A+0227	A+0228	A+0229	A+0230	A+0231	A+0232	A+0233	A+0234	A+0235	A+0236	A+0237	A+0238	A+0239
Fx	A+0240	A+0241	A+0242	A+0243	A+0244	A+0245	A+0246	A+0247	A+0248	A+0249	A+0250	A+0251	A+0252	A+0253	A+0254	A+0255

## Microsoft Windows Codepage 1252

Windows-1252 is a character encoding of the Latin alphabet, used by default in the legacy components of Microsoft Windows in English and some other Western languages.

	00	01	02	03	04	05	06	07	08	09	0A	0B	0C	0D	0E	0F	
00	NUL 0000	STX 0001	SOT 0002	ETX 0003	EOT 0004	ENQ 0005	ACK 0006	BEL 0007	BS 0008	HT 0009	LF 000A	VT 000B	FF 000C	CR 000D	SO 000E	SI 000F	
10	DLE 0010	DC1 0011	DC2 0012	DC3 0013	DC4 0014	NAK 0015	SYN 0016	ETB 0017	CAN 0018	EM 0019	SUB 001A	ESC 001B	FS 001C	GS 001D	RS 001E	US 001F	
20	SP 0020	! 0021	" 0022	# 0023	\$ 0024	% 0025	& 0026	* 0027	( 0028	) 0029	* 002A	+ 002B	, 002C	- 002D	. 002E	/ 002F	
30	0 0030	1 0031	2 0032	3 0033	4 0034	5 0035	6 0036	7 0037	8 0038	9 0039	: 003A	; 003B	< 003C	= 003D	> 003E	? 003F	
40	@ 0040	A 0041	B 0042	C 0043	D 0044	E 0045	F 0046	G 0047	H 0048	I 0049	J 004A	K 004B	L 004C	M 004D	N 004E	O 004F	
50	P 0050	Q 0051	R 0052	S 0053	T 0054	U 0055	V 0056	W 0057	X 0058	Y 0059	Z 005A	[ 005B	\ 005C	] 005D	^ 005E	_ 005F	
60	` 0060	a 0061	b 0062	c 0063	d 0064	e 0065	f 0066	g 0067	h 0068	i 0069	j 006A	k 006B	l 006C	m 006D	n 006E	o 006F	
70	p 0070	q 0071	r 0072	s 0073	t 0074	u 0075	v 0076	w 0077	x 0078	y 0079	z 007A	{ 007B	 007C	} 007D	~ 007E	DEL 007F	
80	€ 20AC	• 20A2	ƒ 20A8	• 20A9	• 20AA	• 20AB	• 20AC	• 20AD	• 20AE	• 20AF	• 20B0	• 20B1	• 20B2	• 20B3	• 20B4	• 20B5	• 20B6
90	• 20B7	• 20B8	• 20B9	• 20BA	• 20BB	• 20BC	• 20BD	• 20BE	• 20BF	• 20C0	• 20C1	• 20C2	• 20C3	• 20C4	• 20C5	• 20C6	• 20C7
A0	NBSP 00A0	ı 00A1	ı 00A2	ı 00A3	ı 00A4	ı 00A5	ı 00A6	ı 00A7	ı 00A8	ı 00A9	ı 00AA	ı 00AB	ı 00AC	ı 00AD	ı 00AE	ı 00AF	
B0	• 00B0	• 00B1	• 00B2	• 00B3	• 00B4	• 00B5	• 00B6	• 00B7	• 00B8	• 00B9	• 00BA	• 00BB	• 00BC	• 00BD	• 00BE	• 00BF	
C0	À 00C0	Á 00C1	Â 00C2	Ã 00C3	Ä 00C4	Å 00C5	Æ 00C6	Ç 00C7	È 00C8	É 00C9	Ê 00CA	Ë 00CB	Ì 00CC	Í 00CD	Î 00CE	Ï 00CF	
D0	Ð 00D0	Ñ 00D1	Ò 00D2	Ó 00D3	Ô 00D4	Õ 00D5	Ö 00D6	× 00D7	Ø 00D8	Ù 00D9	Ú 00DA	Û 00DB	Ü 00DC	Ý 00DD	Ë 00DE	Ë 00DF	
E0	à 00E0	á 00E1	â 00E2	ã 00E3	ä 00E4	å 00E5	æ 00E6	ç 00E7	è 00E8	é 00E9	ê 00EA	ë 00EB	ì 00EC	í 00ED	î 00EE	ï 00EF	
F0	ë 00F0	ñ 00F1	ò 00F2	ó 00F3	ô 00F4	õ 00F5	ö 00F6	÷ 00F7	ø 00F8	ù 00F9	ú 00FA	û 00FB	ü 00FC	ý 00FD	Ë 00FE	Ë 00FF	



# ASCII Chart

ASCII Char.	Hex No.	ASCII Char.	Hex No.	ASCII Char.	Hex No.	ASCII Char.	Hex No.
NUL	00	SP	20	@	40	'	60
SOH	01	!	21	A	41	a	61
STX	02	"	22	B	42	b	62
ETX	03	#	23	C	43	c	63
EOT	04	\$	24	D	44	d	64
ENQ	05	%	25	E	45	e	65
ACK	06	&	26	F	46	f	66
BEL	07	'	27	G	47	g	67
BS	08	(	28	H	48	h	68
HT	09	)	29	I	49	i	69
LF	0A	*	2A	J	4A	j	6A
VT	0B	+	2B	K	4B	k	6B
FF	0C	,	2C	L	4C	l	6C
CR	0D	-	2D	M	4D	m	6D
SO	0E	.	2E	N	4E	n	6E
SI	0F	/	2F	O	4F	o	6F
DLE	10	0	30	P	50	p	70
DC1	11	1	31	Q	51	q	71
DC2	12	2	32	R	52	r	72
DC3	13	3	33	S	53	s	73
DC4	14	4	34	T	54	t	74
NAK	15	5	35	U	55	u	75
SYN	16	6	36	V	56	v	76
ETB	17	7	37	W	57	w	77
CAN	18	8	38	X	58	x	78
EM	19	9	39	Y	59	y	79
SUB	1A	:	3A	Z	5A	z	7A
ESC	1B	;	3B	[	5B	{	7B
FS	1C	<	3C	\	5C		7C
GS	1D	=	3D	]	5D	}	7D
RS	1E	>	3E	^	5E	~	7E
US	1F	?	3F	_	5F	DEL	7F



[www.datalogic.com](http://www.datalogic.com)

**Datalogic S.r.l.**

Via S. Vitalino, 13 | Lippo di Calderara di Reno  
40012 BO | Italy | Telephone: (+39) 051-3147011  
Fax: (+39) 051-3147205

©2019 Datalogic S.r.l. ▪ All rights reserved. Datalogic and the Datalogic logo are registered trademarks of Datalogic S.p.A. in many countries, including the U.S.A. and the E.U. Motionix and Gryphon are trademarks of Datalogic S.p.A. or of Datalogic Group companies, registered in the U.S.



820103714

Rev. B

January 2019